

# Orthopaedics

**1 Retractors**

Retraktoren  
Écarteurs  
Separadores  
Divaricatori

**27 Elevators**

Elevatorien  
Élévateurs  
Elevadores  
Elevatori

**Periosteal (Raspatories)**

Raspatorien  
Rugines périostiques  
Periostótomos (Legras)  
Scollaperiosteo (Periostotomi)

**Bone ?les**

Knochenfeilen  
Limes à os  
Limas para hueso  
Lime per osso

**Sharp Curettes**

Scharfe Küretten  
Curettes tranchantes  
Curetas cortantes  
Curette taglienti

**63 Surgical Mallets**

Chirurgische Hämmer  
Maillets chirurgicaux  
Martillos quirúrgicos  
Martelli chirurgici

**Tampers**

Stößels  
Compacteurs  
Compactadores  
Compattatori

**Osteotomes**

Osteotome  
Ostéotomes  
Osteótomos  
Osteotomi

**Chisels**

Meißeln  
Burins  
Cinceles  
ScalPELLI

**87 Bone surgery**

Knochenchirurgie  
Chirurgie osseuse  
Cirugía ósea  
Chirurgia ossea

**Bone Holding Forceps**

Knochenhaltezeuge  
Daviers à os  
Pinzas de sujeción  
Pinze per ?ssare l?osso

**Hand Surgery**

Handchirurgie  
Chirurgie de la main  
Cirugía de la mano  
Chirurgia della mano

**Bone Rongeurs**

Hohlmeißelzangen  
Pincés gouges  
Pinzas gubias  
Pinze ossivore

**Bone Cutting Scissors**

Knochensplitterscheren  
Ciseaux à os  
Tijeras para huesos  
Forbici ossivore

**115 Wires and Nails**

Bohrdrähte  
Broches et clous  
Agujas y clavos  
Fili e chiodi

**Extension Bows**

Extensionsbügel  
Étriers d'extension  
Arcos de tracción  
Archi da trazione

**Twist Drills**

Spiralbohrer  
Forets  
Brocas espirales  
Maschiatori - Taps

**Osteosintese**

Osteosynthesis  
Ostéosynthèse  
Osteosíntesis  
Osteosintesi

**Hand Drills**

Handbohrapparate  
Perceuses à main  
Perforadores manuales  
Perforatori a mano

**Screwdrivers**

Schraubendreher  
Tournevis  
Destornilladores  
Cacciaviti

**143 Measuring Instruments**

Messinstrumente  
Instruments à mesurer  
Instrumentos de medición  
Strumenti per misura

**149 Forceps for plattes**

Biege und schränkhebel  
Pincés à courber pour plaques  
Pinzas para placas  
Pinze e chiavi per placche

**Wire Guides**

Drahtumführungs-nadel  
Aiguilles passe-?ls  
Agujas pasa hilos  
Passa?li

**Needle Holders**

Nadelhalter  
Porte-aiguilles  
Porta-agujas  
Port?aghi

**Cutting Pliers**

Schneidezangen  
Pincés coupante  
Alicates de corte  
Tronchesi di taglio

**169 Retractors**

Retraktoren  
Écarteurs  
Separadores  
Divaricatori

**Nervhaken**

Nerve Hooks  
Crochets à nerfs  
Ganchos para nervios  
Uncini per nervi

**Micro Dissectors**

Mikro-Dissektoren  
Micro Dissecteurs  
Micro Disecadores  
Micro Dissettori

**189 Suction Tubes**

Saugkanülen  
Canules d?aspiration  
Cánulas de aspiración  
Cannule per aspirazione

**Laminectomy**

Laminektomie  
Laminectomia  
Laminectomía  
Laminectomia

**Extension Bows**

Extensionsbügel  
Étriers d'extension  
Arcos de tracción  
Archi da trazione

**Knives**

Messer  
Couteaux  
Cuchillos  
Coltelli

**Bone ?les**

Knochenfeilen  
Limes à os  
Limas para hueso  
Lime per osso

**Scalpels**

Skalpelle  
Bistouris  
Bisturías  
Bisturi

**207 Towel Clamps**

Tuchklemmen  
Pince ?xe-compresses  
Pinzas de campo  
Fissateli

**Scissors**

Scheren  
Ciseaux  
Tijeras  
Forbici

**Tissue Forceps**

Chirurgische Pinzetten  
Pincés à tissus  
Pinzas quirúrgicas  
Pinzette chirurgiche

**Needle Holders**

Nadelhalter  
Porte-aiguilles  
Porta-agujas  
Port?aghi

**Hemostatic Forceps**

Arterienklemmen  
Pincés hémostatiques  
Pinzas hemostáticas  
Pinzette emostatiche

**221 Alphanumerical Index**

Alphanumerischen Index  
Index alphanumérique  
Indice alfanumérico  
Indice alfanumerico

**Traumatology - Orthopaedics**

Traumatologie - Orthopädie  
Traumatologie - Orthopédie  
Traumatología - Ortopedia  
Traumatologia - Ortopedia

**Table of Contents**

Inhaltsverzeichnis  
Table des matières  
Tabla de contenido  
Tavola dei contenuti

## Company: WAA Ortho industry

SCCI Registration Number: A-70741

Address: Raja Road Bucher Khana 22/325 Sialkot Pakistan

Cell: +92-3106234115,

Whatsaap: +92-3374745643

Emails: info@waaorthoind.com

waaortho@gmail.com

Web: [www.waaorthoind.com](http://www.waaorthoind.com)



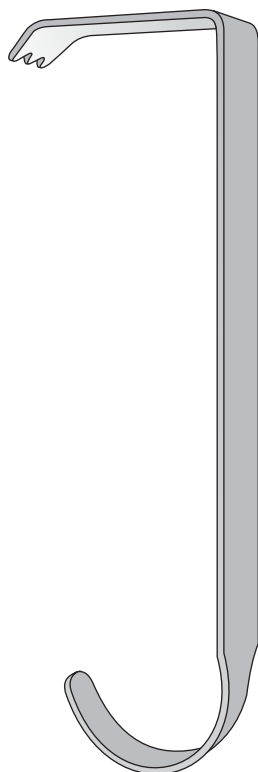

HIBBS  
**WIS-BT-23/WIS-BT-24**  
240 mm

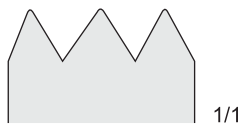

1/1

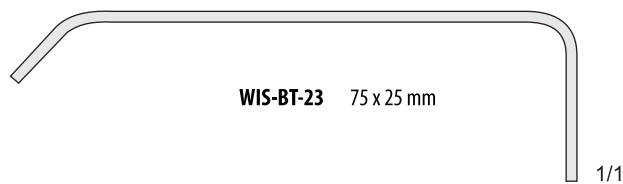

**WIS-BT-23** 75 x 25 mm

1/1

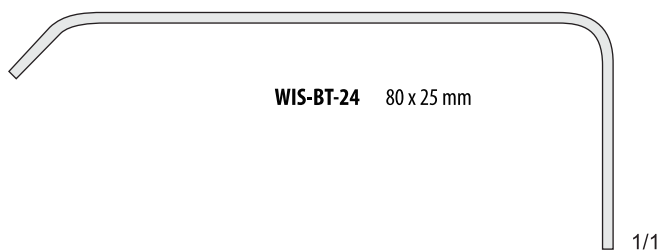

**WIS-BT-24** 80 x 25 mm

1/1

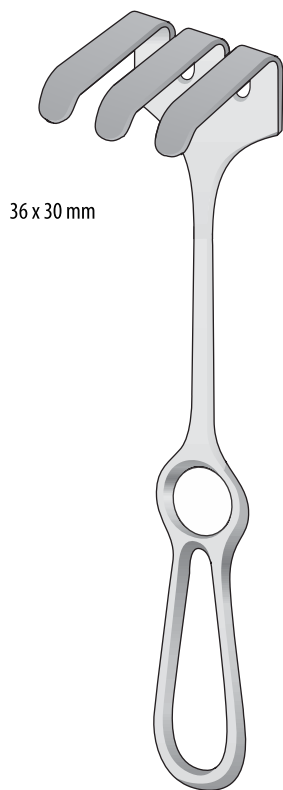

36 x 30 mm

OLLIER  
**WIS-BT-124**  
225 mm

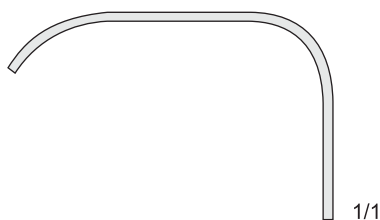

1/1

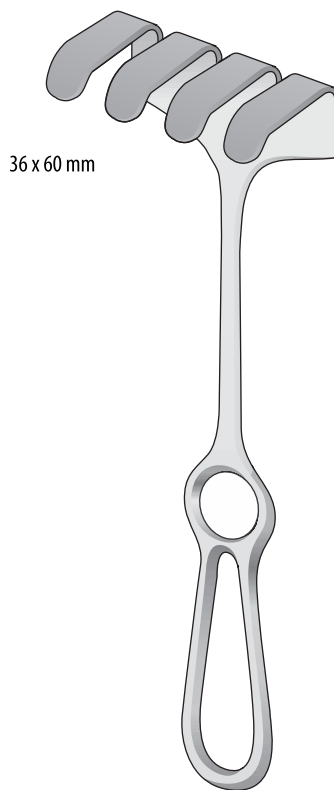

36 x 60 mm

OLLIER  
**WIS-BT-125**  
225 mm

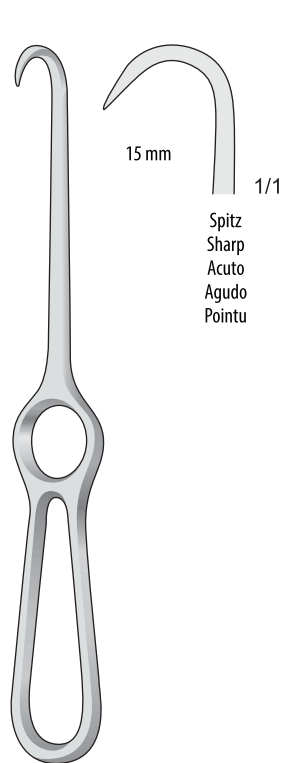

Spitz  
Sharp  
Acuto  
Agudo  
Pointu

**KOCHER**  
**WIS-BT-139**  
205 mm



Stumpf  
Blunt  
Smusso  
Romo  
Mousse

**WAAWAAORTHO**  
INDUSTRY  
**Sialkot Pakistan**

**KOCHER**  
**WIS-BT-140**  
220 mm

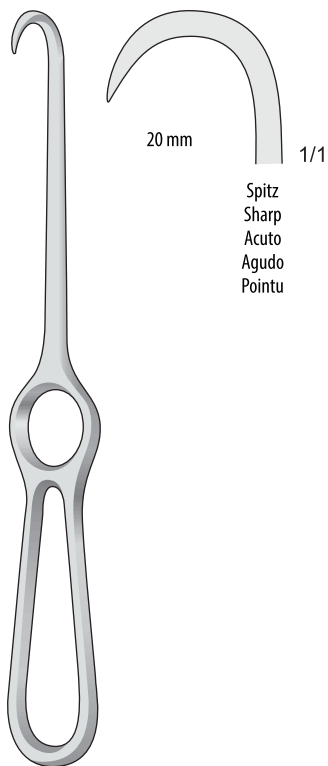

Spitz  
Sharp  
Acuto  
Agudo  
Pointu

**VOLKMANN**  
**WIS-BT-126**  
220 mm

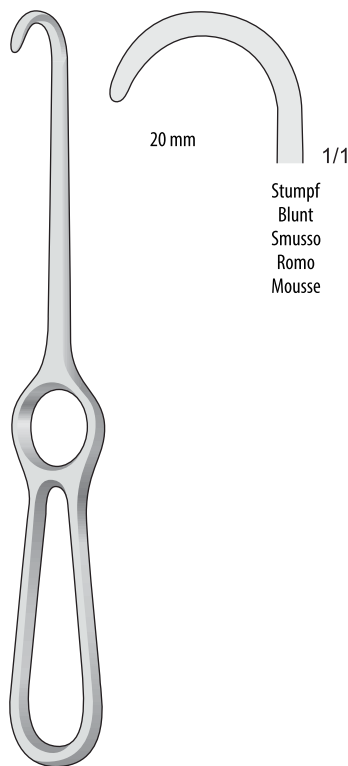

Stumpf  
Blunt  
Smusso  
Romo  
Mousse

**VOLKMANN**  
**WIS-BT-127**  
220 mm

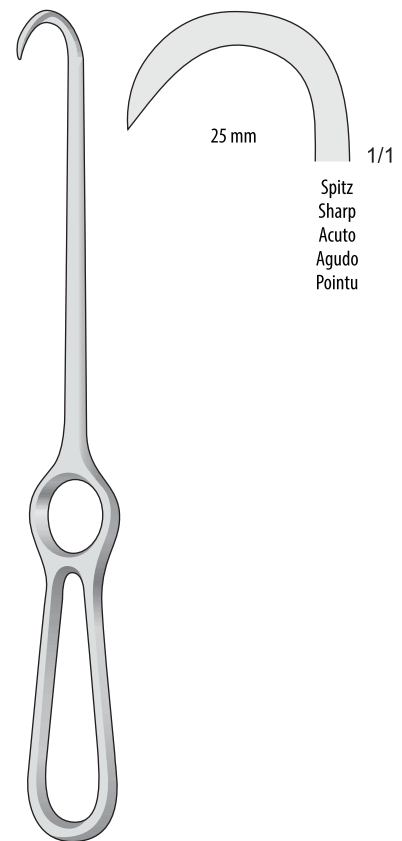

Spitz  
Sharp  
Acuto  
Agudo  
Pointu

**WIS-BT-128**  
245 mm

Spitz  
Sharp  
Acuto  
Agudo  
Pointu

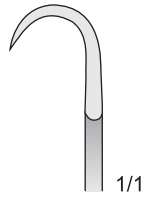

**WIS-BT-101**  
9 x 8 mm



**WIS-BT-103**  
9 x 13 mm



**WIS-BT-105**  
9 x 19 mm

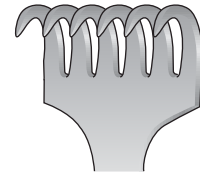

**WIS-BT-107**  
9 x 29 mm

Stumpf  
Blunt  
Smusso  
Romo  
Mousse

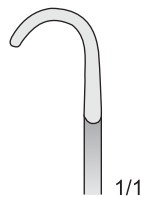

**WIS-BT-102**  
9 x 8 mm



**WIS-BT-104**  
9 x 13 mm



**WIS-BT-106**  
9 x 19 mm

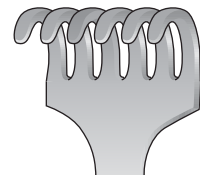

**WIS-BT-108**  
9 x 29 mm

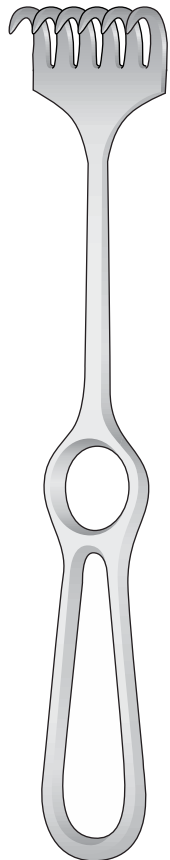

**VOLKMANN**  
**WIS-BT-101/WIS-BT-108**  
220 mm

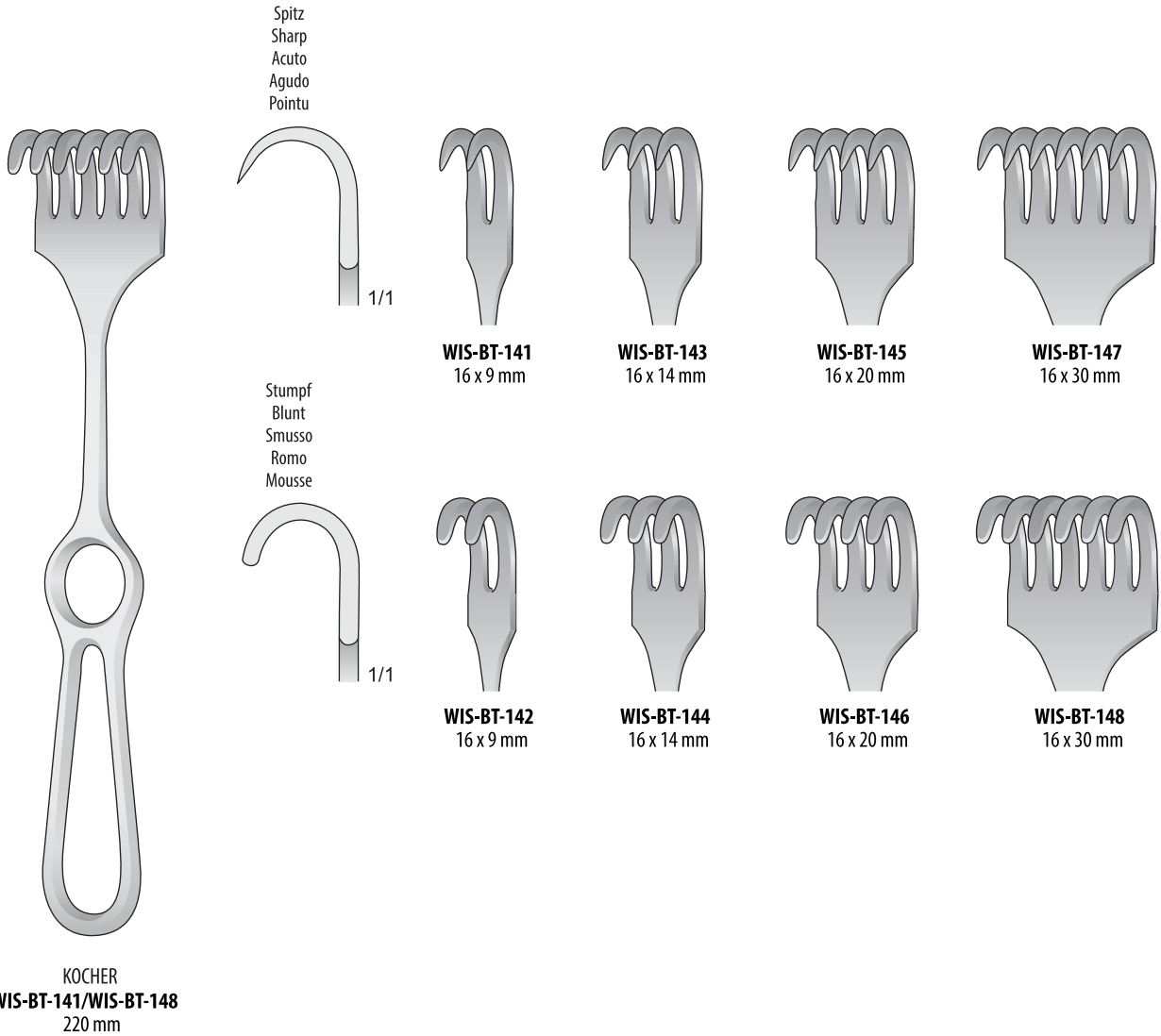

40 x 40 mm

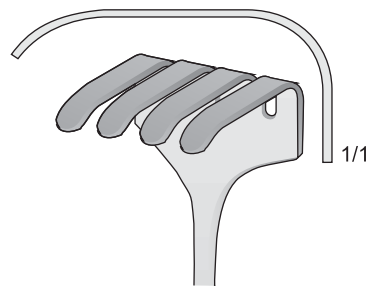

**WIS-BT-120**

45 x 50 mm

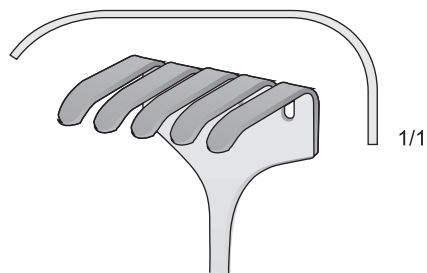

**WIS-BT-121**

50 x 60 mm

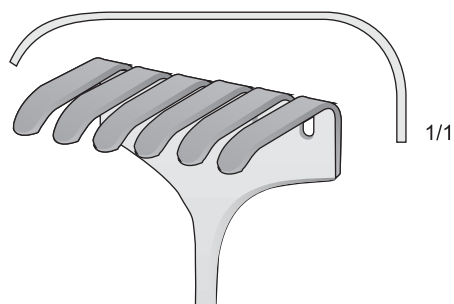

**WIS-BT-122**

70 x 70 mm

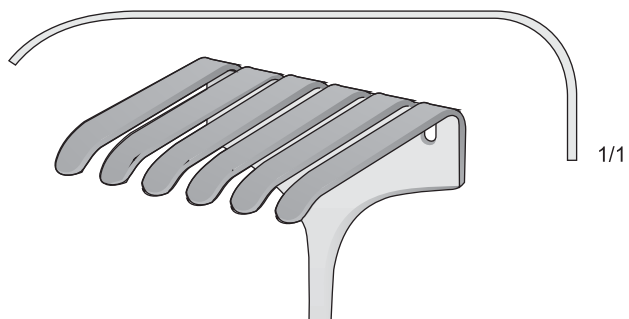

**WIS-BT-123**

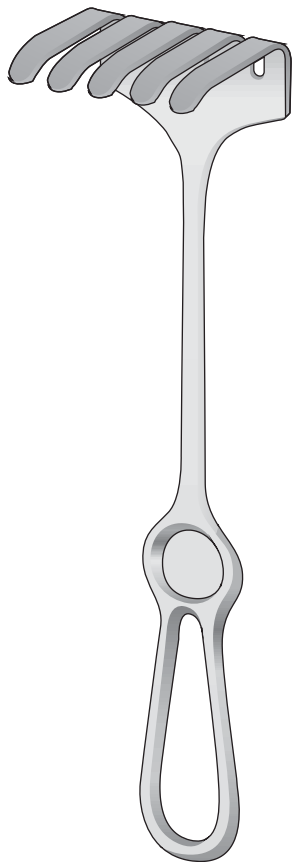

ISRAEL  
**WIS-BT-120/WIS-BT-123**  
250 mm



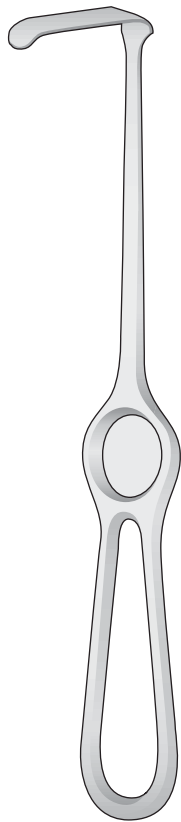

**KOCHER-LANGENBECK**  
**WIS-BT-60/WIS-BT-263**  
215 mm

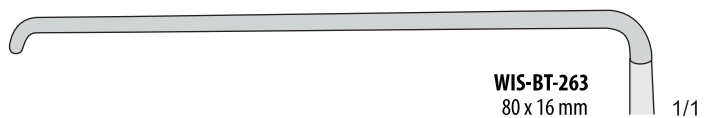
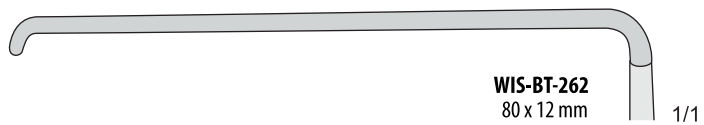
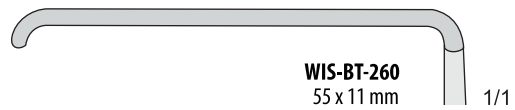
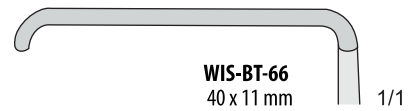
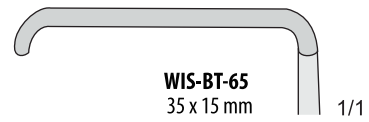
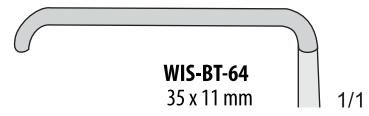
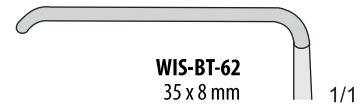
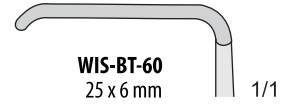



SAUERBRUCH  
WIS-BT-110/WIS-BT-112  
225 mm

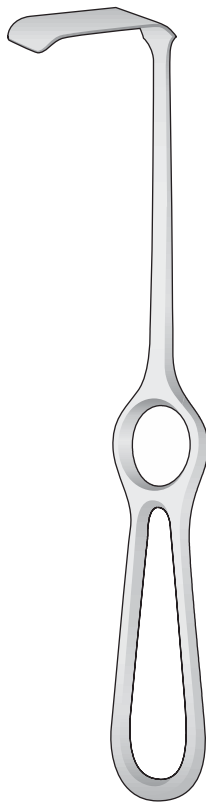
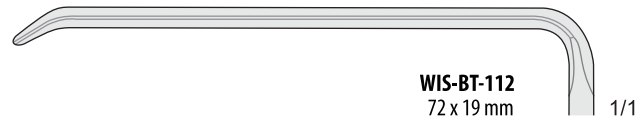
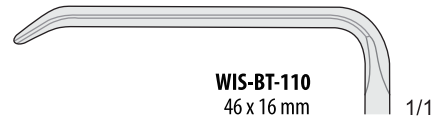

KOCHER  
WIS-BT-250/WIS-BT-254  
230 mm

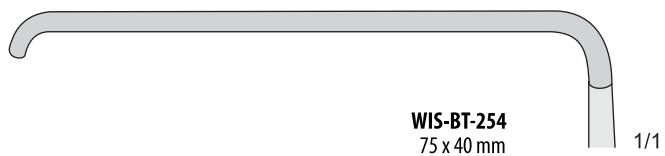
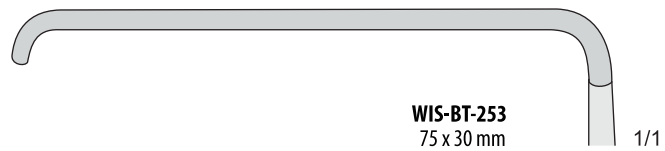
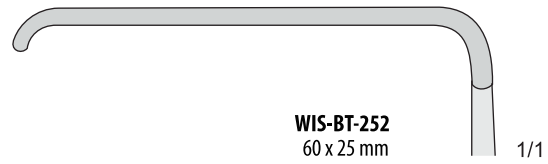
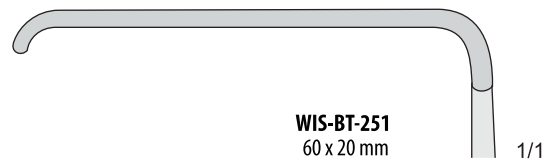
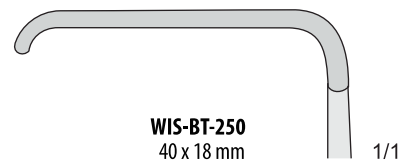

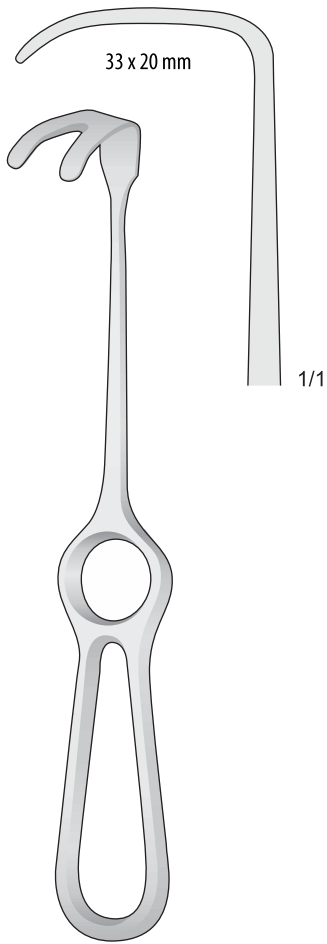

WASSMUND  
**WIS-BT-69**  
220 mm

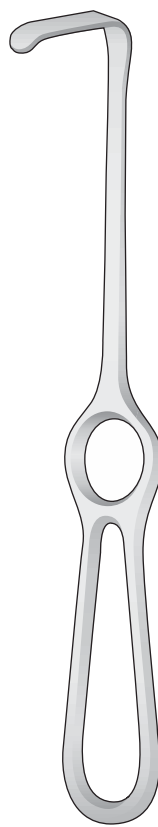

LANGENBECK  
**WIS-BT-33/WIS-BT-43**  
210 mm

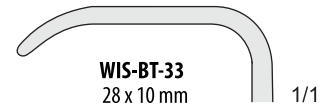

**WIS-BT-33**  
28 x 10 mm

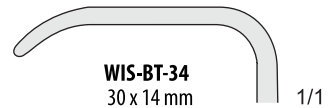

**WIS-BT-34**  
30 x 14 mm

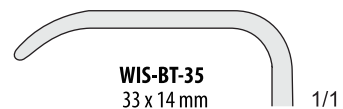

**WIS-BT-35**  
33 x 14 mm

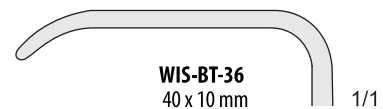

**WIS-BT-36**  
40 x 10 mm

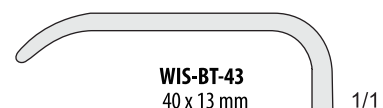

**WIS-BT-43**  
40 x 13 mm

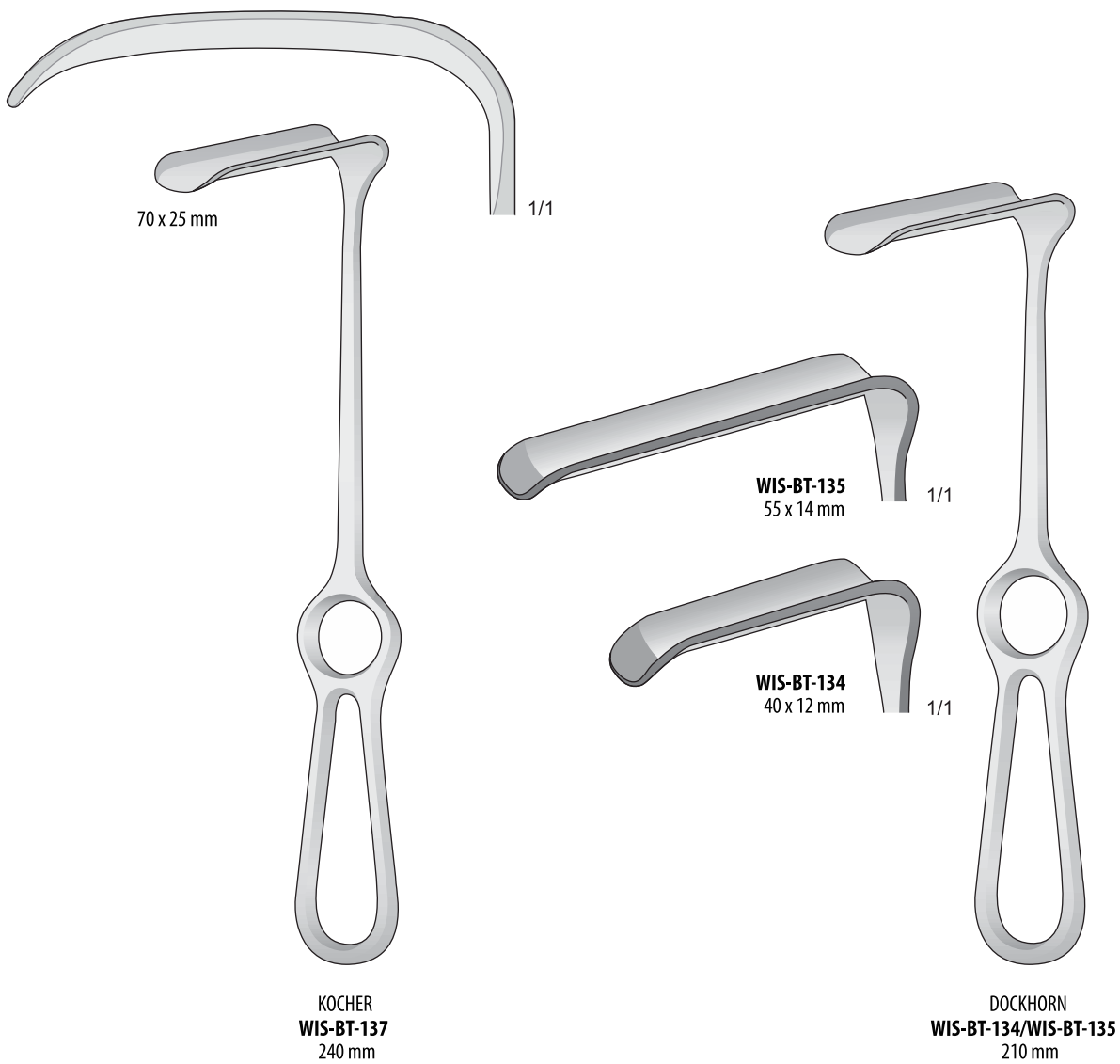

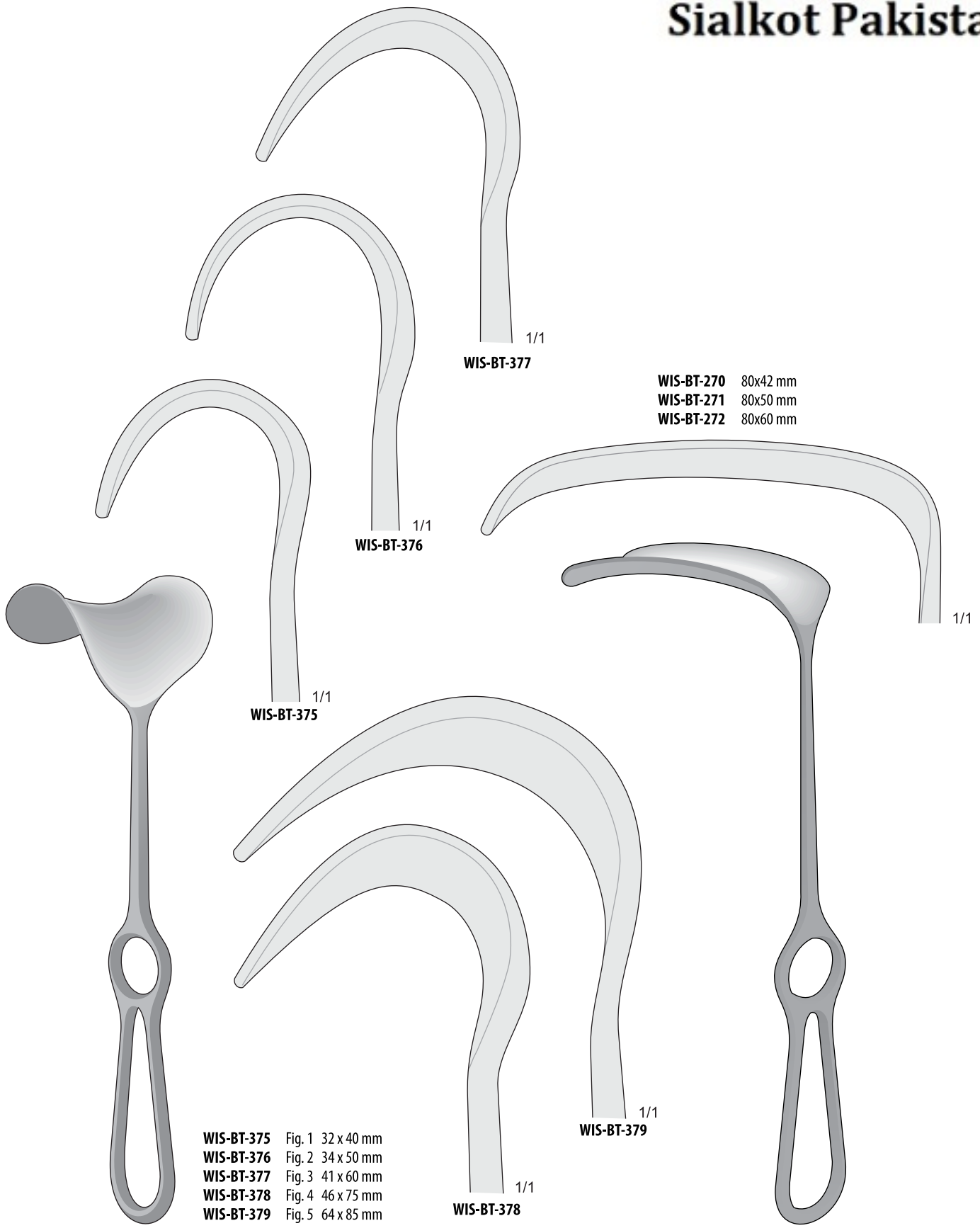

FRITSCH  
**WIS-BT-375/WIS-BT-379**  
240 mm

KOCHER  
**WIS-BT-270/WIS-BT-272**  
250 mm

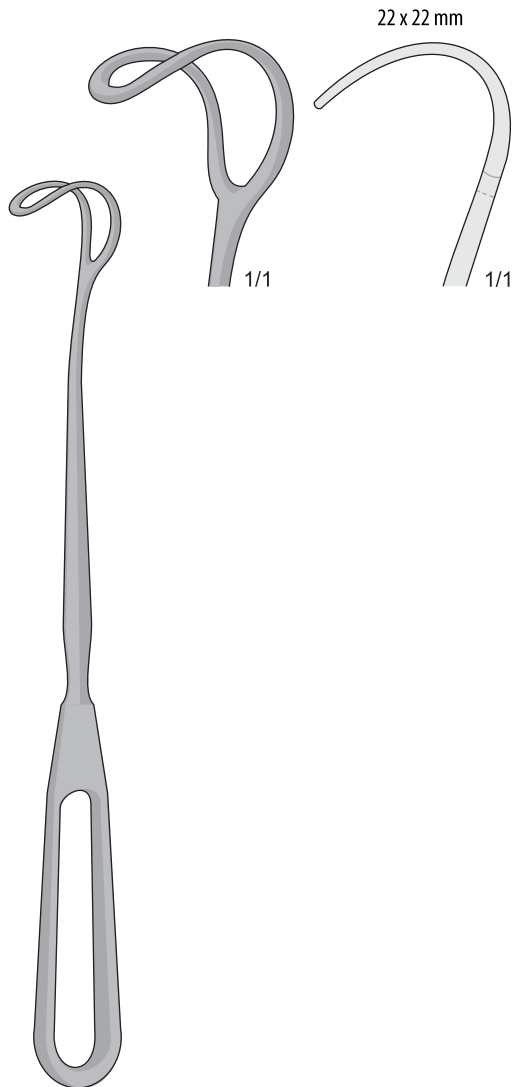

GREENE  
**WIS-BT-131**  
225 mm

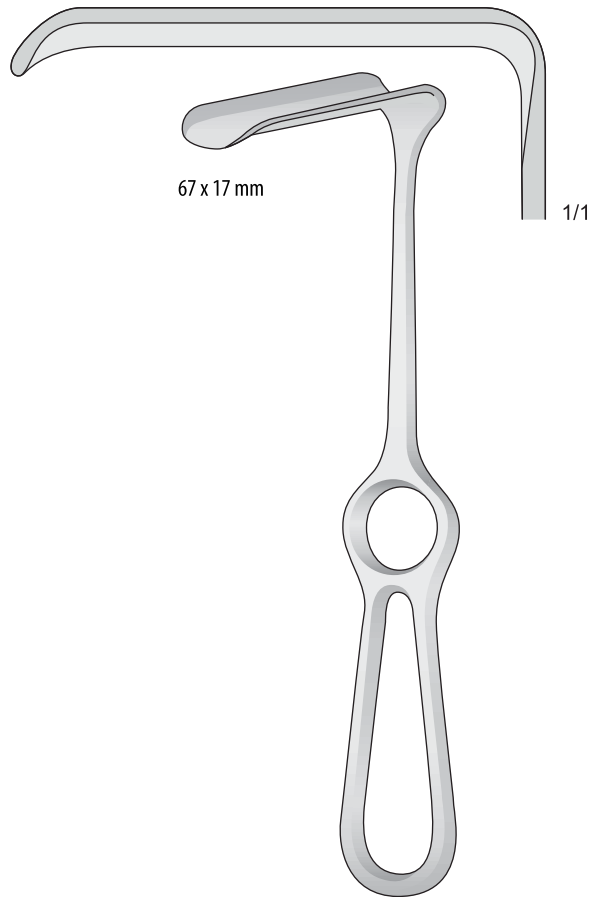

CASPAR  
**WIS-BT-161**  
210 mm

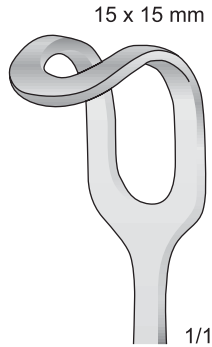

**WIS-BT-80**  
225 mm

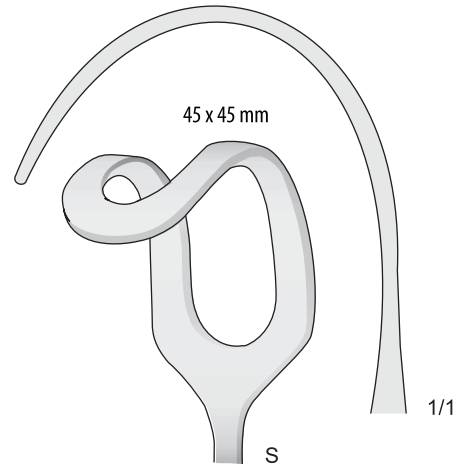

**WIS-BT-180**  
255 mm

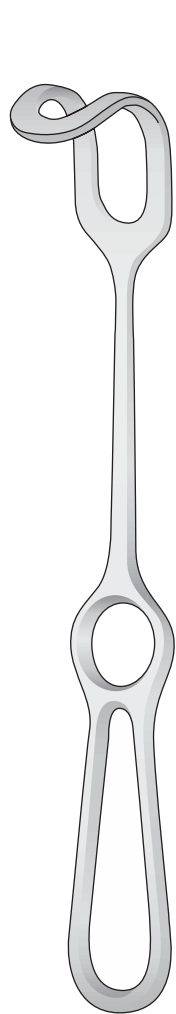

**WIS-BT-81**  
225 mm

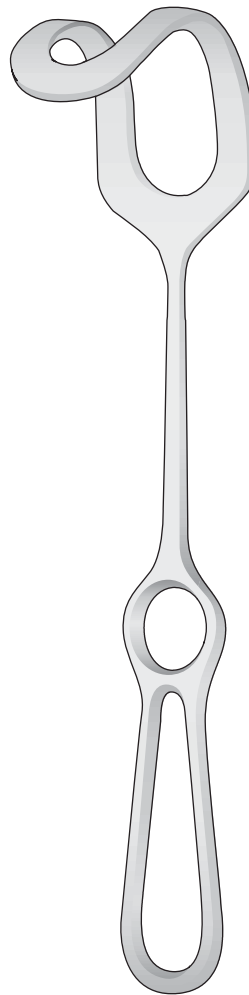

**WIS-BT-181**  
255 mm

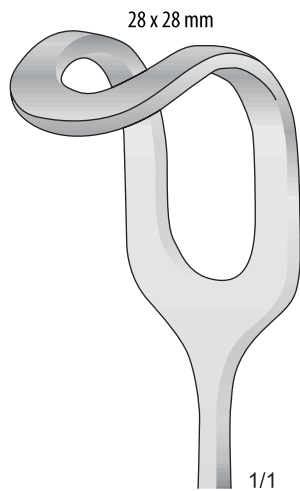

**WIS-BT-82**  
225 mm

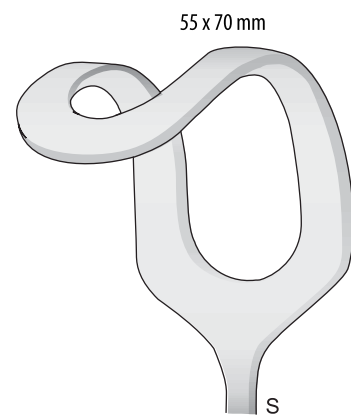

**WIS-BT-182**  
255 mm

MIDDELDORPF  
**WIS-BT-80/WIS-BT-82**  
225 mm

MIDDELDORPF  
**WIS-BT-180/WIS-BT-182**  
255 mm

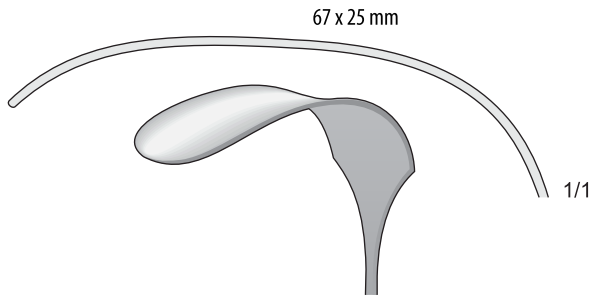
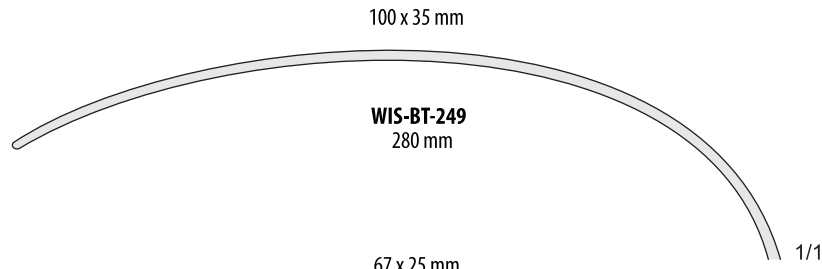

**WIS-BT-270** 80x42 mm  
**WIS-BT-271** 80x50 mm  
**WIS-BT-272** 80x60 mm

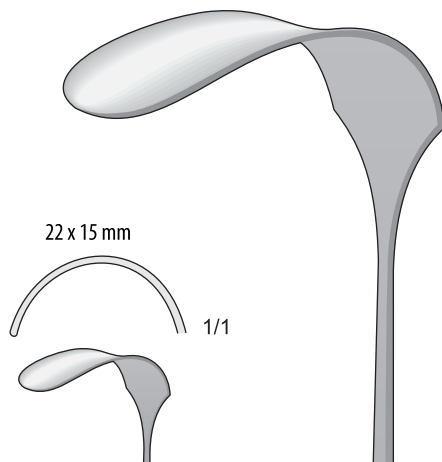
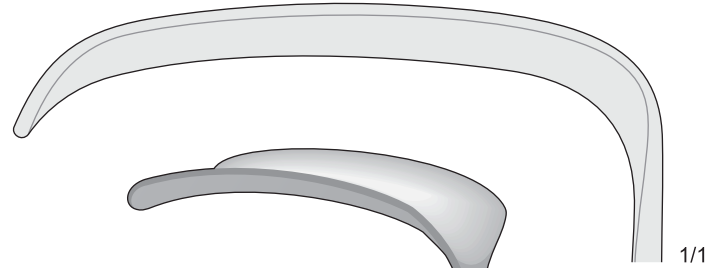

**WIS-BT-246**  
280 mm



**WIS-BT-247**  
280 mm

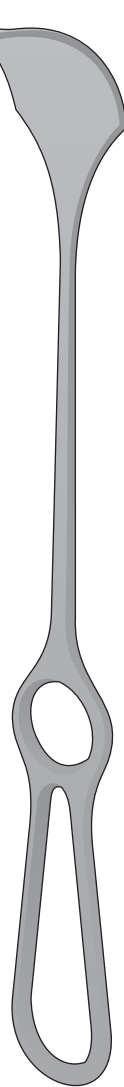

**KOCHER**  
**WIS-BT-246/WIS-BT-249**  
280 mm

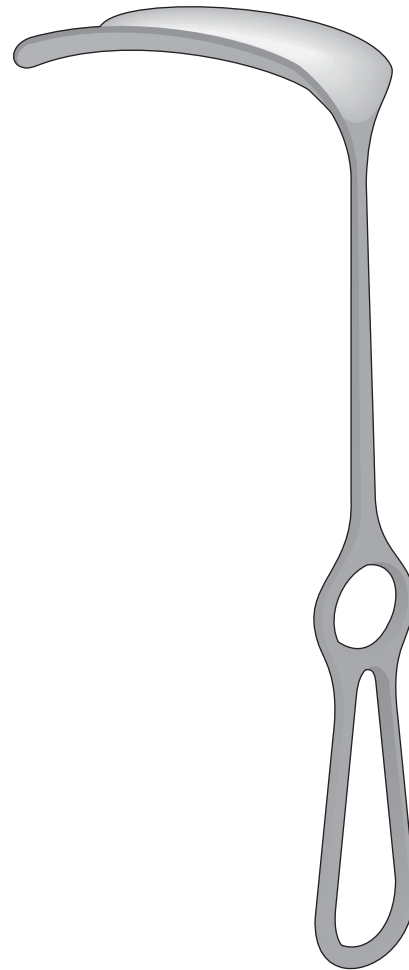

**KOCHER**  
**WIS-BT-270/WIS-BT-272**  
250 mm



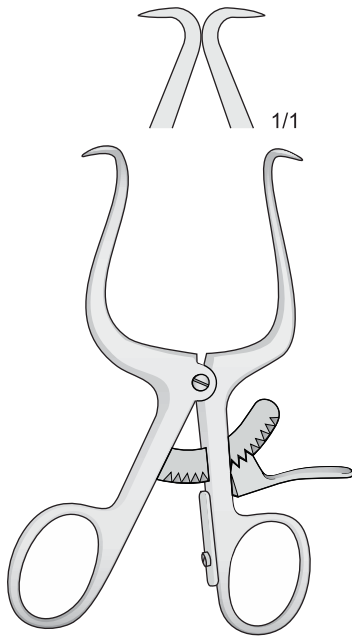

GELPI  
**WIS-BV-14**  
90 mm

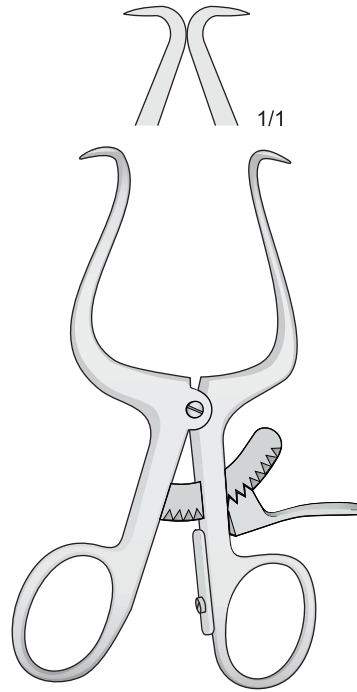

GELPI  
**WIS-BV-15**  
110 mm

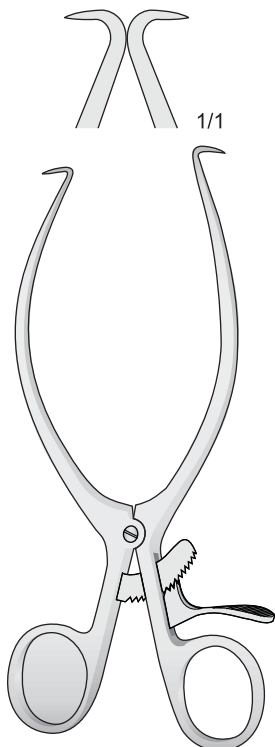

GELPI  
**WIS-BV-16**  
140 mm

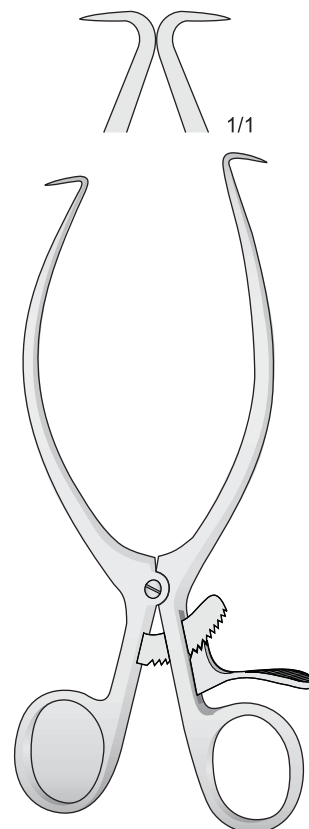

GELPI  
**WIS-BV-17**  
180 mm

# WAAWAAORTHO INDUSTRY Sialkot Pakistan

Femur-Wundspreizer f?r kinder  
Femur Retractor for children  
Divaricatore femorale per bambini

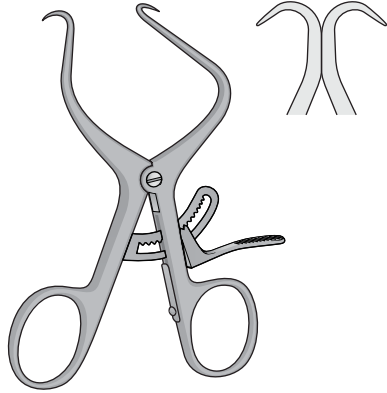

DE BAKEY  
WIS-BV-315  
100 mm

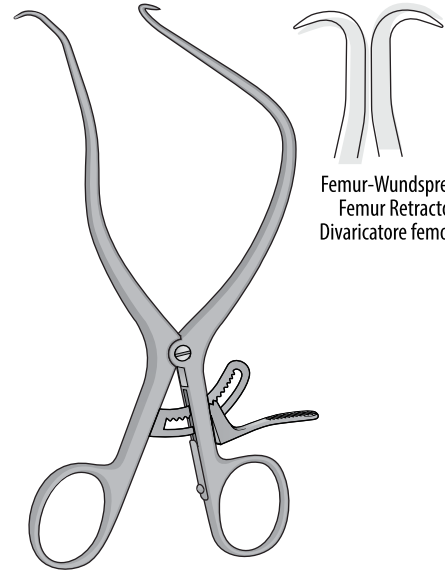

Femur-Wundspreizer  
Femur Retractor  
Divaricatore femorale

DE BAKEY  
WIS-BV-316  
170 mm

Wundspreizer  
Retractors for shoulder  
Divaricatori da spalla  
Separadores  
Écarteurs

Stumpf - Blunt  
Smusso - Romo  
Mousse

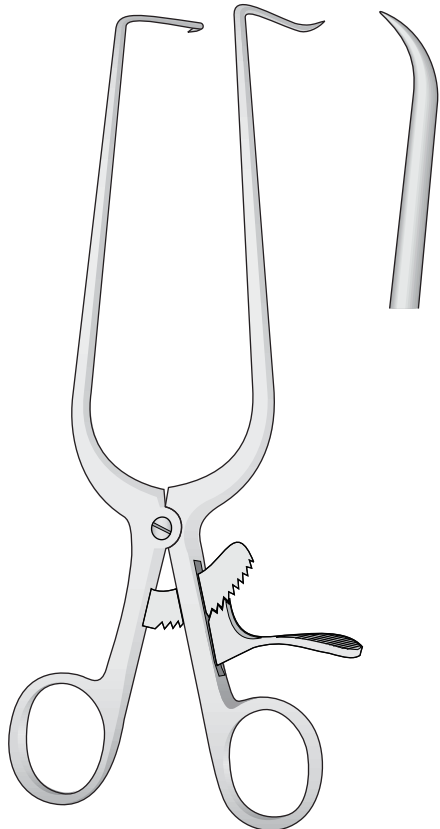

WIS-BV-100  
215 mm

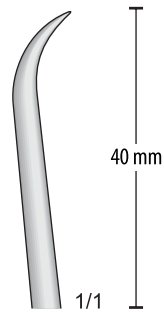

Stumpf - Blunt  
Smusso - Romo  
Mousse

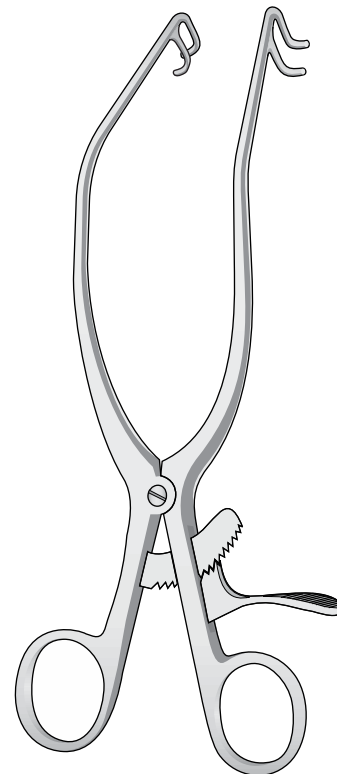

K?LBEL  
WIS-BV-103  
180 mm

# WAAOORTH INDUSTRY Sialkot Pakistan

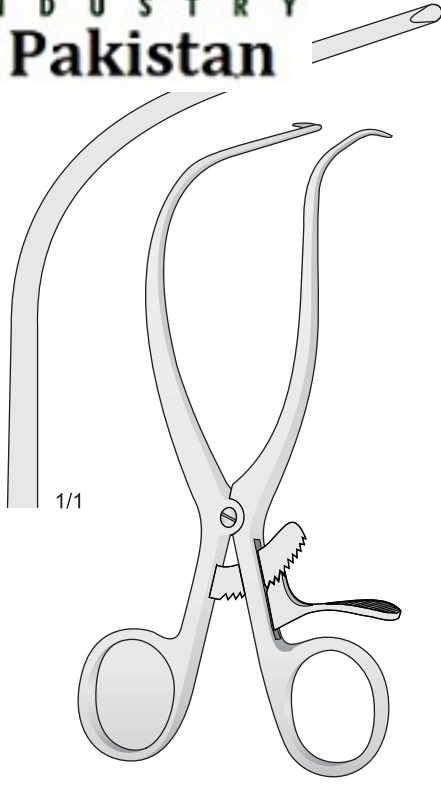

GELPI-SELETZ  
WIS-BV-11  
165 mm

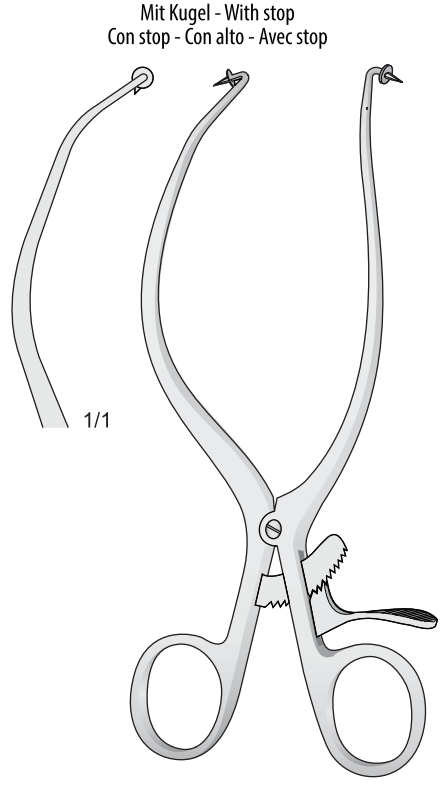

Mit Kugel - With stop  
Con stop - Con alto - Avec stop

GELPI-LOKTITE  
WIS-BV-13  
190 mm

Spitz  
Scharp  
Acuto  
Agudo  
Pointu

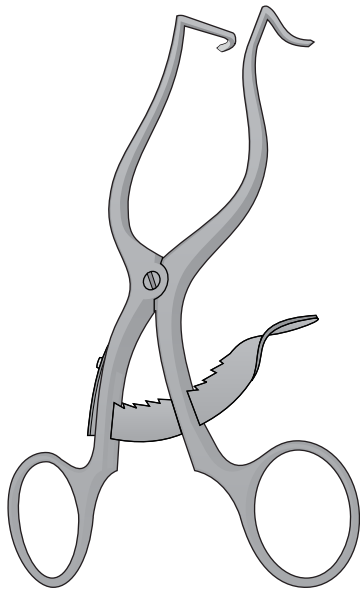

CLOWARD-CONTOUR  
WIS-BV-108  
140 mm

Stumpf  
Blunt  
Smusso  
Romas  
Mousse

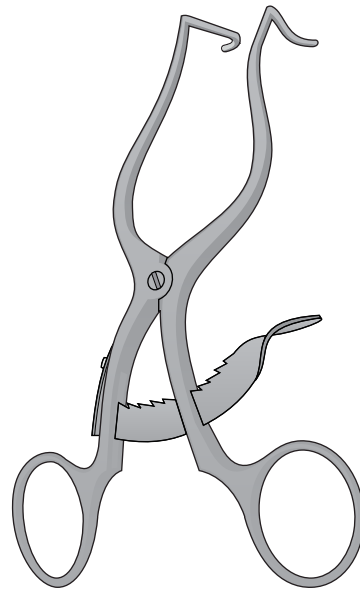

CLOWARD-CONTOUR  
WIS-BV-109  
140 mm

**WAAWAAORTHO**  
INDUSTRY  
**Sialkot Pakistan**

Spitz  
Scharp  
Acuto  
Agudo  
Pointu

Stumpf  
Blunt  
Smusso  
Romas  
Mousse

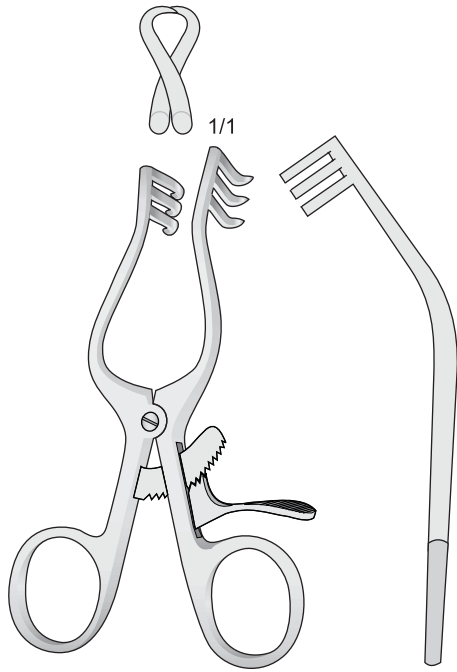

WULLSTEIN  
**WIS-BV-111**  
105 mm

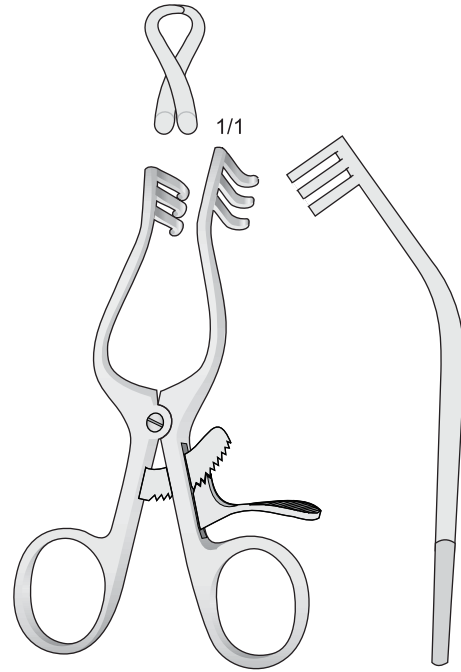

WULLSTEIN  
**WIS-BV-112**  
105 mm

Spitz  
Scharp  
Acuto  
Agudo  
Pointu

Stumpf  
Blunt  
Smusso  
Romas  
Mousse

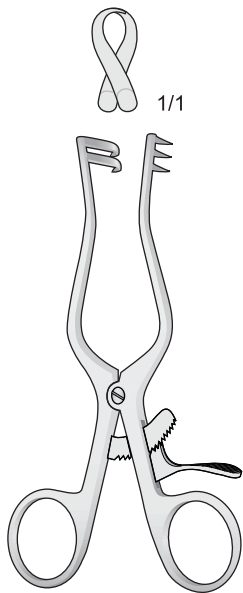

WEITLANER  
**WIS-BV-07**  
110 mm

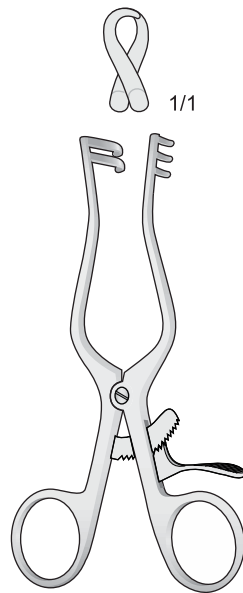

WEITLANER  
**WIS-BV-09**  
110 mm

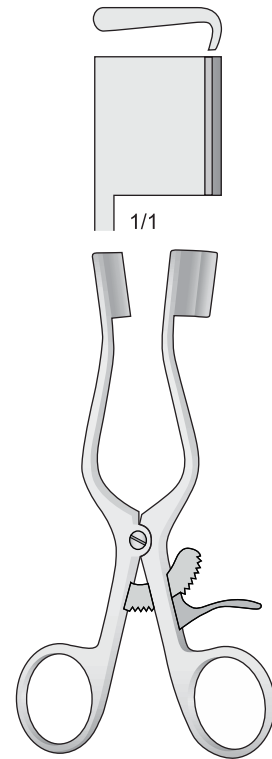

BABY-WEITLANER  
**WIS-BV-26**  
140 mm

Halbscharf - Semi Sharp - Semi acuto  
Semi Agudas - Semi Pointu



1/1

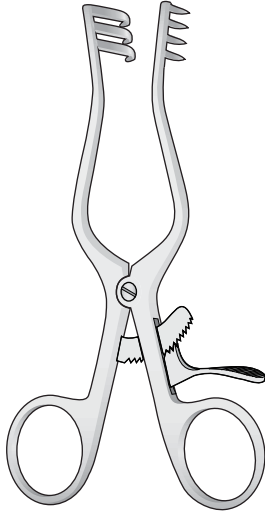

WEITLANER  
**WIS-BV-18**  
135 mm

Spitz - Sharp - Acuto  
Agudas - Pointu



1/1



WEITLANER  
**WIS-BV-20**  
135 mm

Stumpf - Blunt - Smusso  
Romas - Mousse



1/1

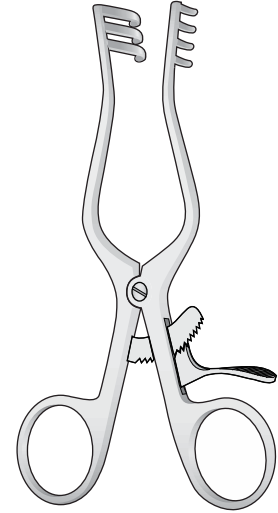

WEITLANER  
**WIS-BV-22**  
135 mm

**WAAWAAORTHO**  
INDUSTRY  
**Sialkot Pakistan**

Spitz - Sharp - Acuto  
Agudas - Pointu

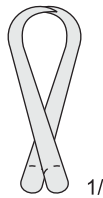

1/1

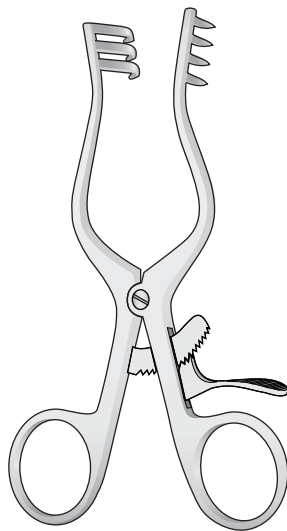

WEITLANER  
**WIS-BV-55**  
135 mm

Stumpf - Blunt - Smusso  
Romas - Mousse



1/1

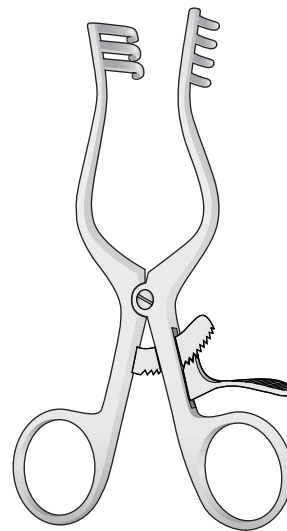

WEITLANER  
**WIS-BV-56**  
135 mm

Halbscharf - Semi Sharp - Semi acuto  
Semi Agudas - Semi Pointu

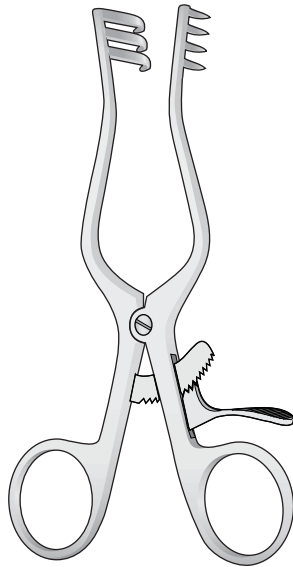

WEITLANER  
**WIS-BV-19**  
165 mm

Spitz - Sharp - Acuto  
Agudas - Pointu

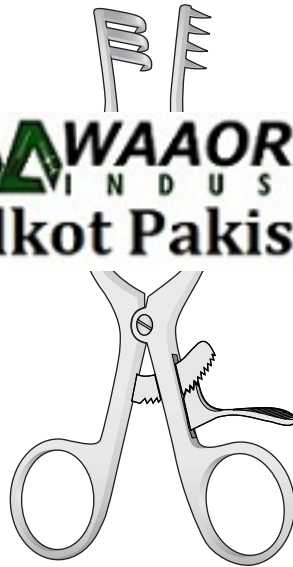

WEITLANER  
**WIS-BV-21**  
165 mm

Stumpf - Blunt - Smusso  
Romas - Mousse

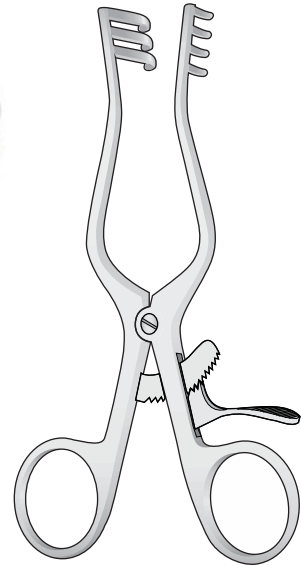

WEITLANER  
**WIS-BV-23**  
165 mm

Spitz - Sharp - Acuto  
Agudas - Pointu

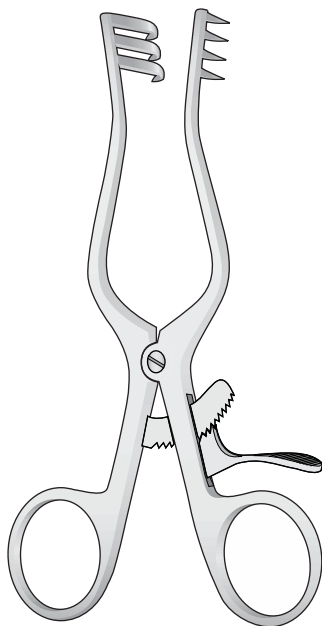

WEITLANER  
**WIS-BV-24**  
200 mm

Stumpf - Blunt - Smusso  
Romas - Mousse

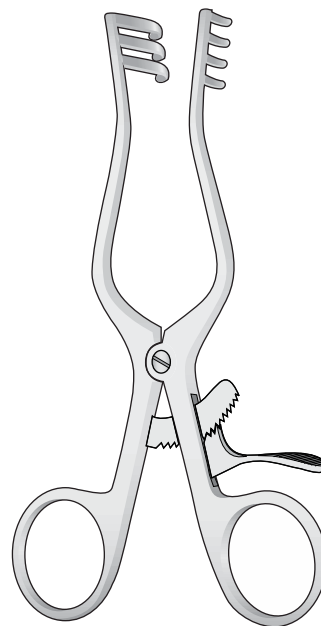

WEITLANER  
**WIS-BV-25**  
200 mm

**WAAWAA** AORTHO  
INDUSTRY  
**Sialkot Pakistan**



Spitz - Sharp - Acuto  
Agudas - Pointu

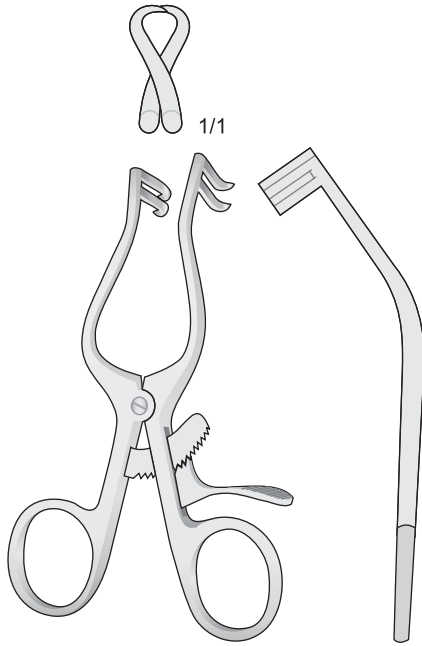

PLESTER  
**WIS-BV-90**  
110 mm

Stumpf - Blunt - Smusso  
Romas - Mousse

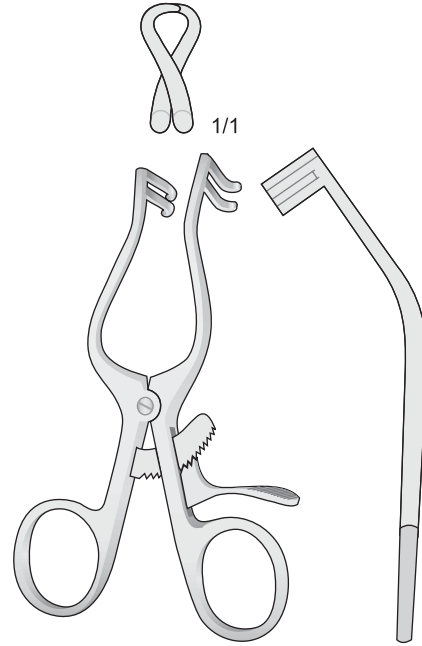

PLESTER  
**WIS-BV-91**  
110 mm

Spitz - Sharp - Acuto  
Agudas - Pointu

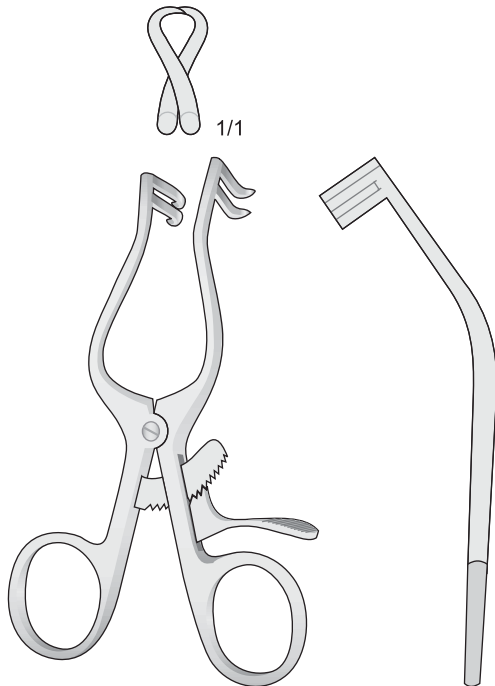

PLESTER  
**WIS-BV-92**  
135 mm

Stumpf - Blunt - Smusso  
Romas - Mousse

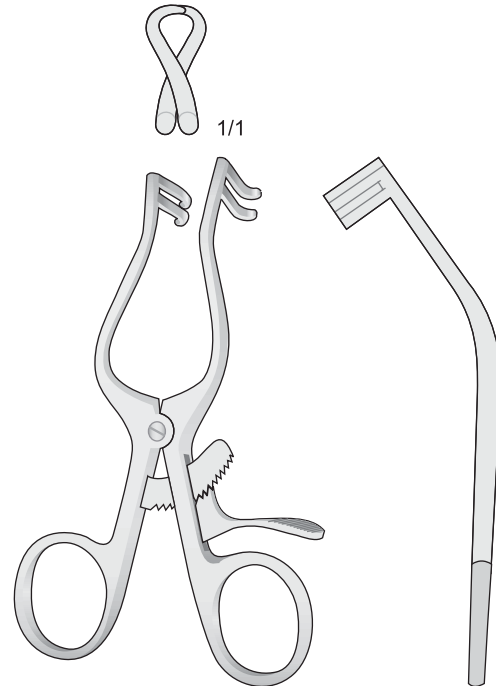

PLESTER  
**WIS-BV-93**  
135 mm

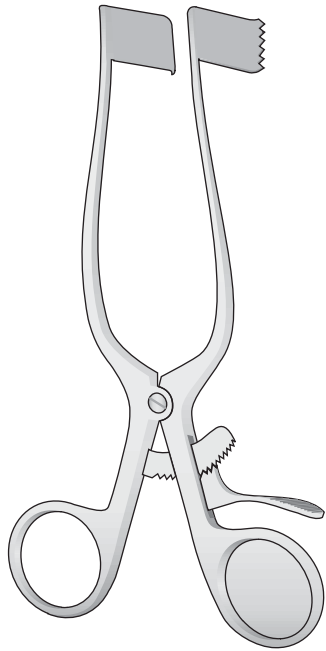

MEYERDING  
**WIS-BV-76** - 32 x 25 mm  
**WIS-BV-77** - 60 x 25 mm  
**WIS-BV-78** - 54 x 25 mm  
**WIS-BV-79** - 60 x 20 mm  
180 mm

Spitz - Sharp - Acuto  
Agudas - Pointu

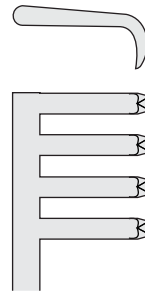

**WIS-BV-117**

Stumpf - Blunt - Smusso  
Romas - Mousse

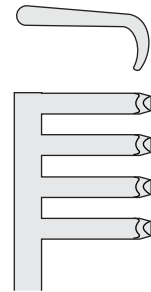

**WIS-BV-118**

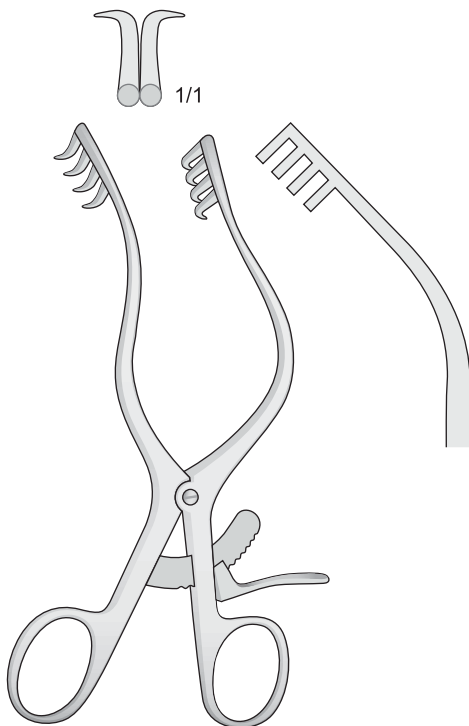

MOLLISON  
**WIS-BV-110**  
160 mm

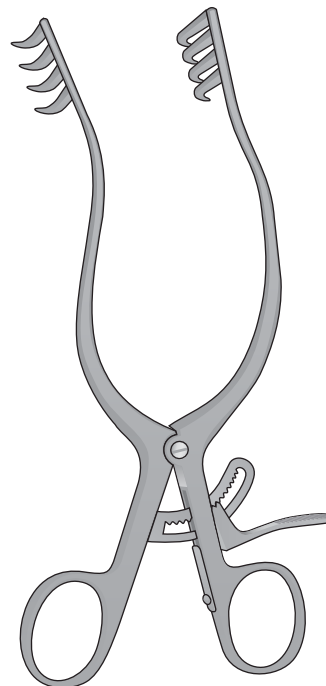

ANDERSON-ADSON  
**WIS-BV-117/WIS-BV-118**  
200 mm





Spitz - Sharp - Acuto  
Agudas - Pointu

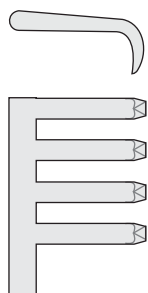

WIS-BV-119

Stumpf - Blunt - Smusso  
Romas - Mousse

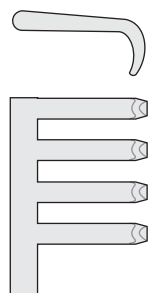

WIS-BV-120

Spitz - Sharp - Acuto  
Agudas - Pointu

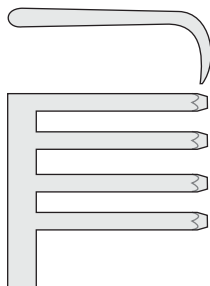

WIS-BV-27

Stumpf - Blunt - Smusso  
Romas - Mousse

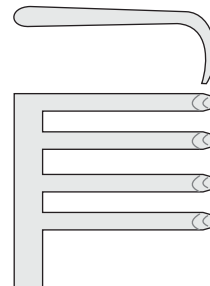

WIS-BV-28

4 x 4 Z?hne  
4 x 4 Teeth  
4 x 4 Denti  
4 x 4 Dientes  
4 x 4 Dents

4 x 4 Z?hne  
4 x 4 Teeth  
4 x 4 Denti  
4 x 4 Dientes  
4 x 4 Dents

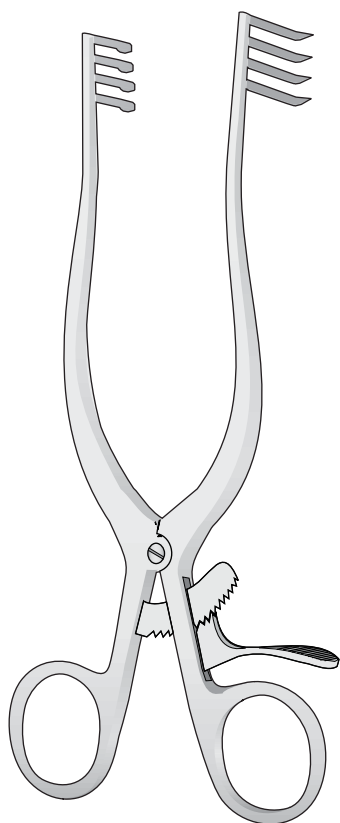

ADSON  
WIS-BV-119/WIS-BV-120  
200 mm

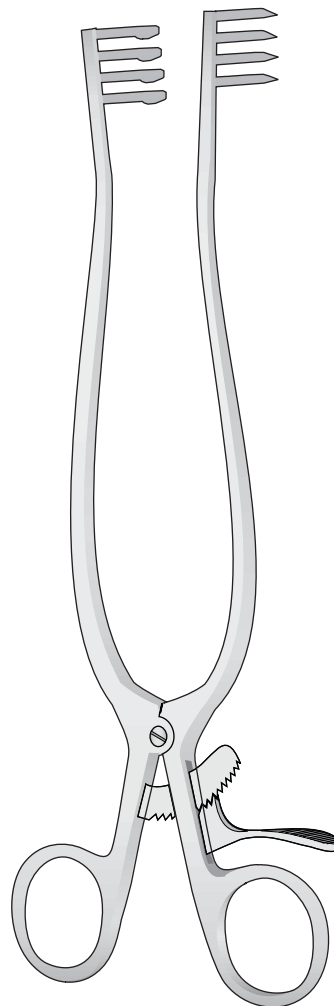

WEITLANER  
WIS-BV-27/WIS-BV-28  
250 mm

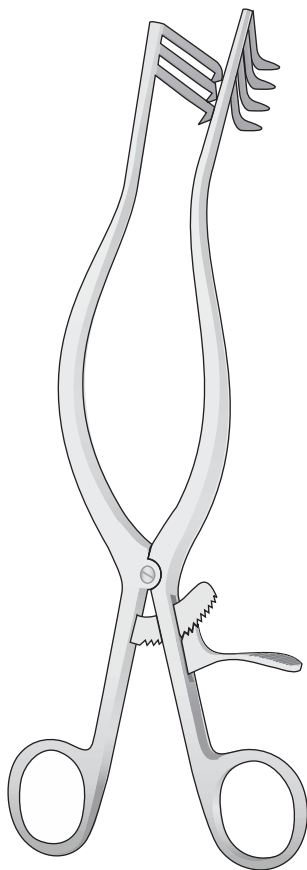

ADSON  
**WIS-BV-190/WIS-BV-193**  
 265 mm

3 x 4 Z?hne  
 3 x 4 Teeth  
 3 x 4 Denti  
 3 x 4 Dientes  
 3 x 4 Dents

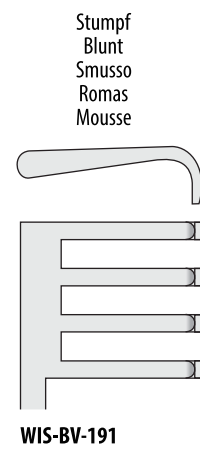
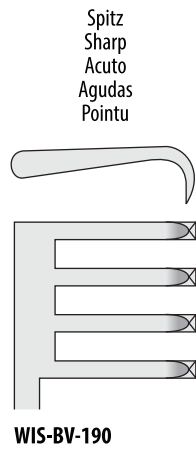

6 x 6 Z?hne  
 6 x 6 Teeth  
 6 x 6 Denti  
 6 x 6 Dientes  
 6 x 6 Dents

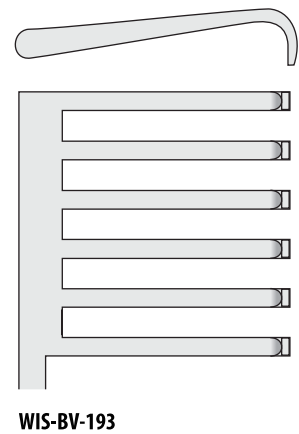
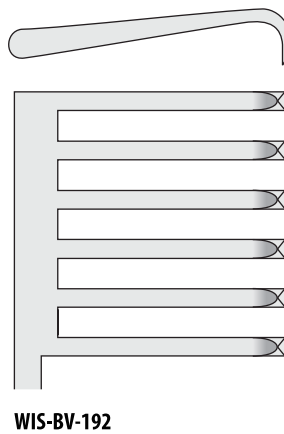

# WAAWAAORTHO INDUSTRY Sialkot Pakistan

Spitz  
Scharp  
Acuto  
Agudo  
Pointu

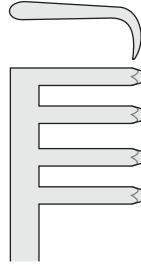

**WIS-BV-68**  
140 mm

Stumpf  
Blunt  
Smusso  
Romas  
Mousse

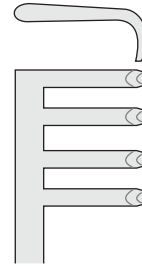

**WIS-BV-70**  
140 mm

3 x 4 Zähne  
3 x 4 Teeth  
3 x 4 Denti  
3 x 4 Dientes  
3 x 4 Dents

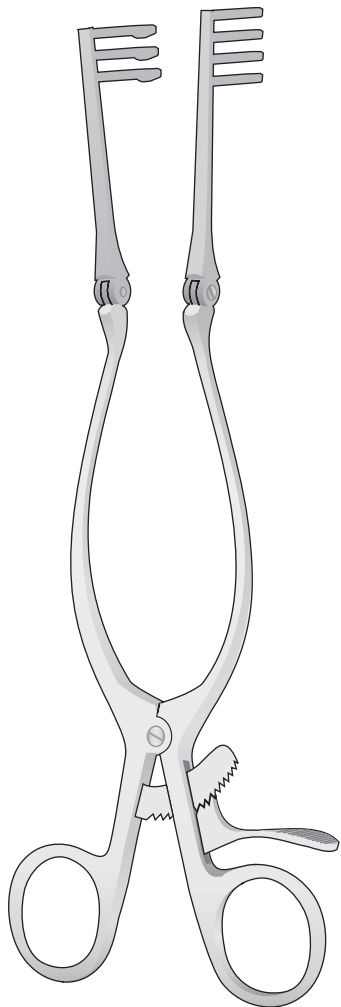

ADSON  
**WIS-BV-68/WIS-BV-75**

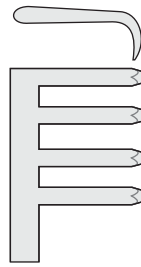

**WIS-BV-69**  
165 mm

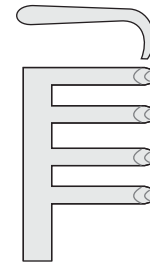

**WIS-BV-71**  
165 mm

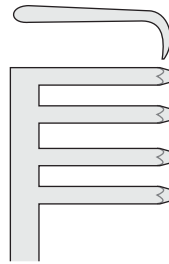

**WIS-BV-72**  
200 mm

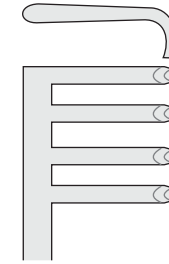

**WIS-BV-73**  
200 mm

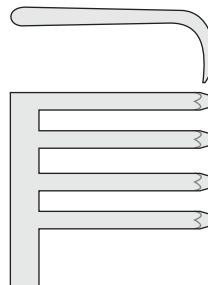

**WIS-BV-74**  
250 mm

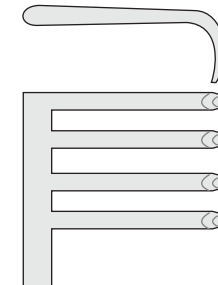

**WIS-BV-75**  
250 mm

**Elevators**

Elevatorien  
Élévateurs  
Elevadores  
Elevatori

**Periosteal (Raspatories)**

Raspatorien  
Rugines périostiques  
Periostótomos (Legras)  
Scollaperiosteo (Periostotomi)

**Bone Files**

Knochenfeilen  
Limes à os  
Limas para hueso  
Lime per osso

**Sharp Curettes**

Scharfe Küretten  
Curettes tranchantes  
Curetas cortantes  
Curette taglienti

Elevatorien

Elevators

Elevatori

Elevadores

Élévateurs

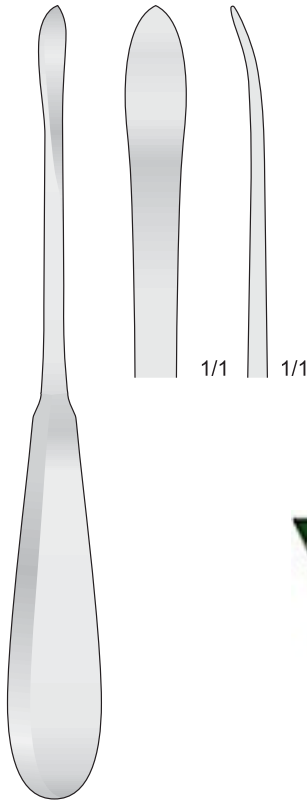

LANGENBECK  
WIS-FK-12  
200 mm

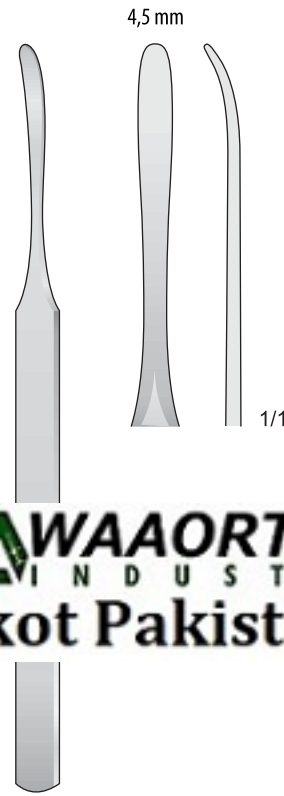

K?NIG  
WIS-KO-1  
155 mm

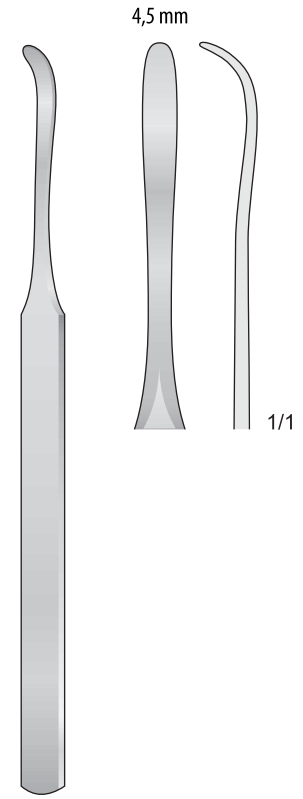

K?NIG  
WIS-KO-2  
155 mm

**WAA**WAA**ORTHO**  
INDUSTRY  
Sialkot Pakistan

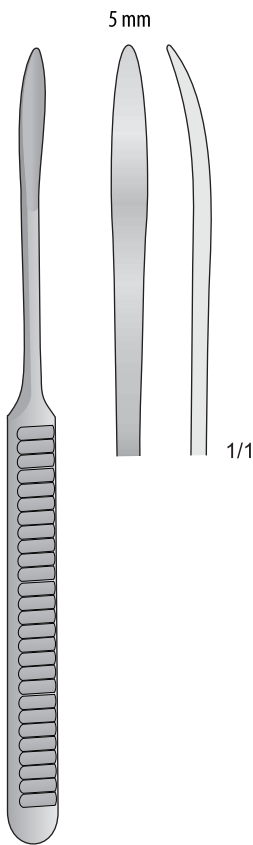

WILLIGER  
WIS-WG-10  
165 mm

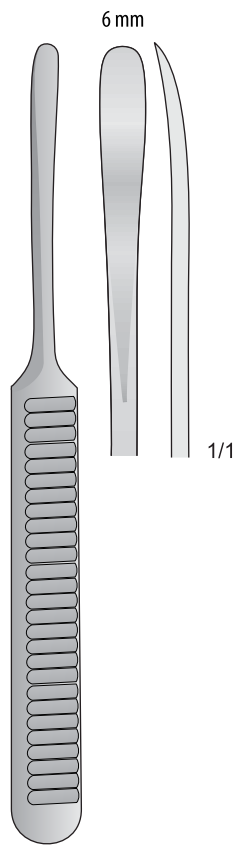

WILLIGER  
WIS-WG-12  
160 mm

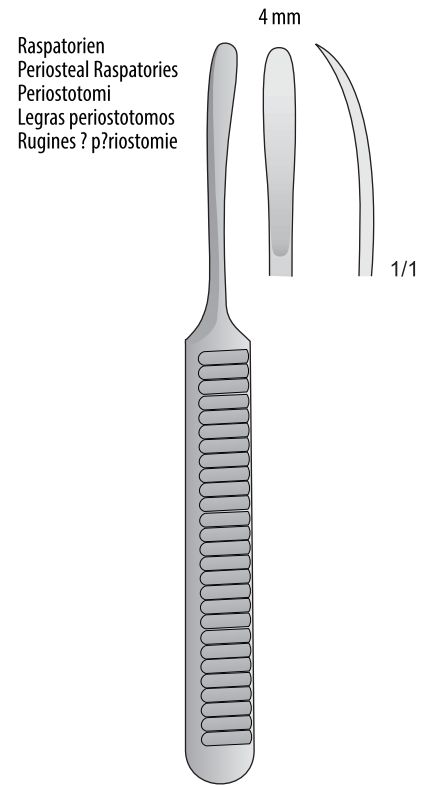

WILLIGER  
WIS-WG-14  
140 mm

Raspatorien  
Periosteal Raspatories  
Periostotomi  
Legras periostotomos  
Rugines ? p?riostomie

Elevatorien

Elevators

Elevatori

Elevadores

Élévateurs

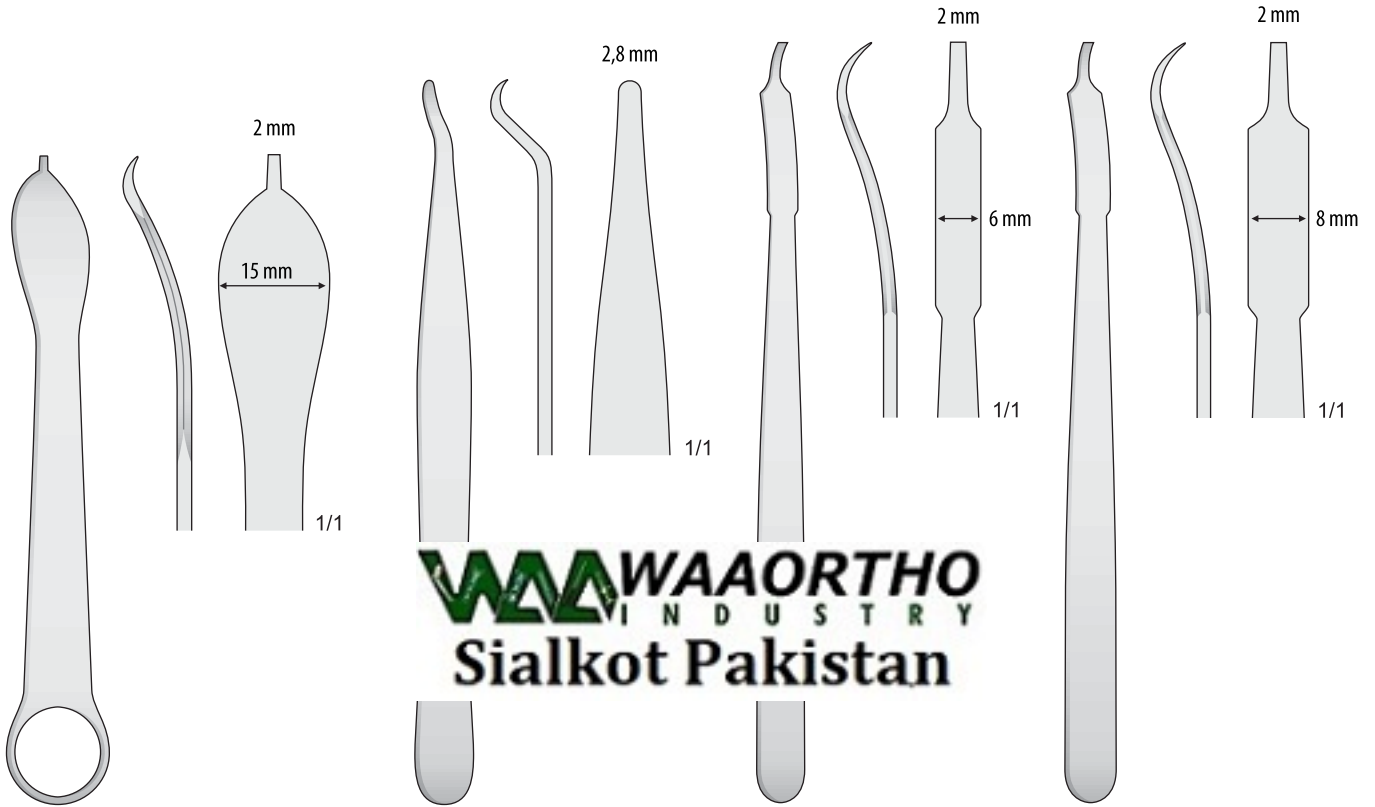

**WIS-FK-45**  
120 mm

**WIS-FK-46**  
140 mm

**MINI-HOHMANN**  
**WIS-FK-48**  
160 mm

**MINI-HOHMANN**  
**WIS-FK-49**  
160 mm

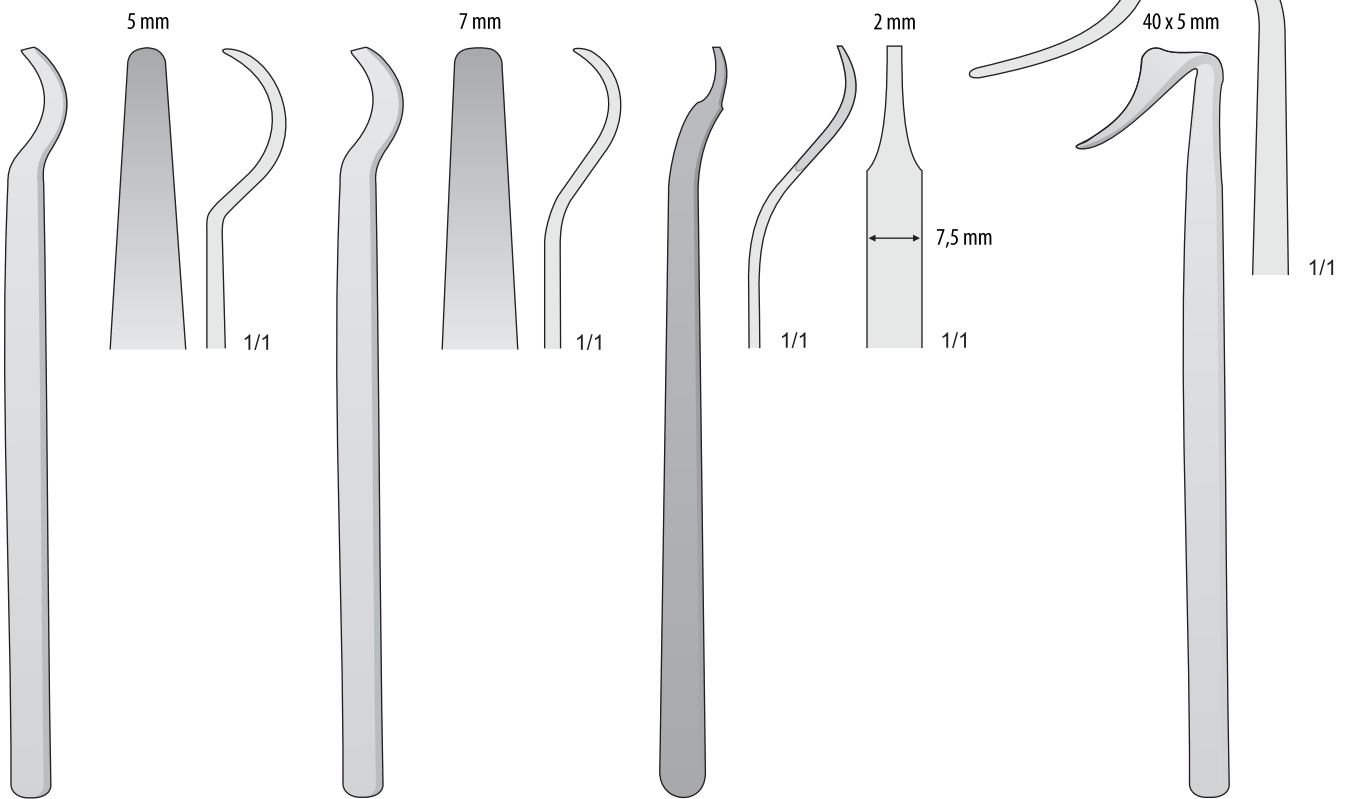

**WIS-FK-30**  
150 mm

**WIS-FK-28**  
150 mm

**BUCK-GRAMCKO**  
**WIS-FK-20**  
150 mm

**BLOUNT**  
**WIS-FK-27**  
175 mm

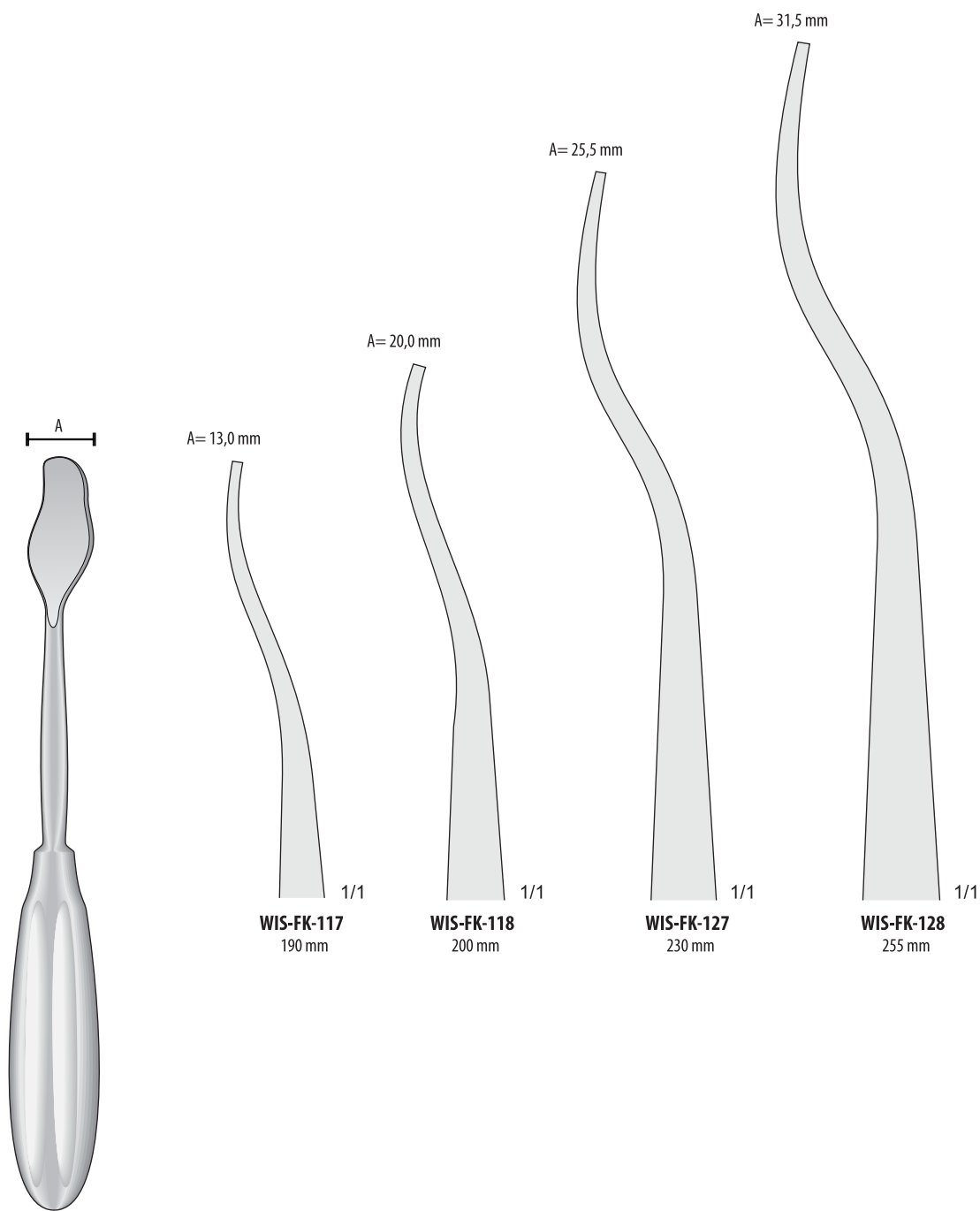

CHANDLER  
**WIS-FK-117/WIS-FK-128**

**WIS-FK-117**  
190 mm

**WIS-FK-118**  
200 mm

**WIS-FK-127**  
230 mm

**WIS-FK-128**  
255 mm

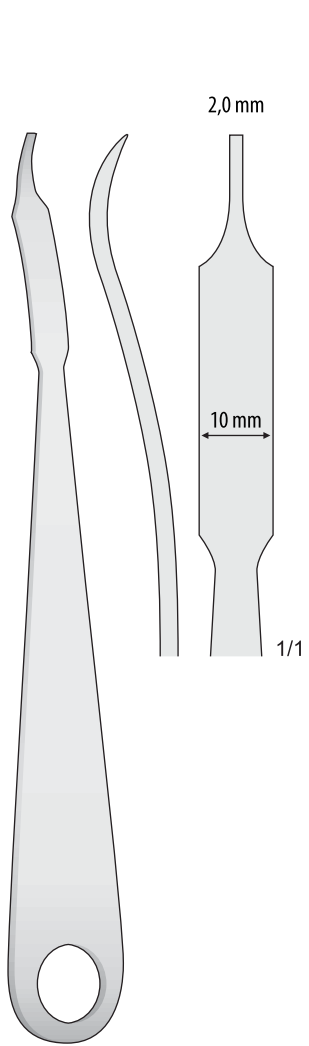

**WIS-FK-51**  
220 mm

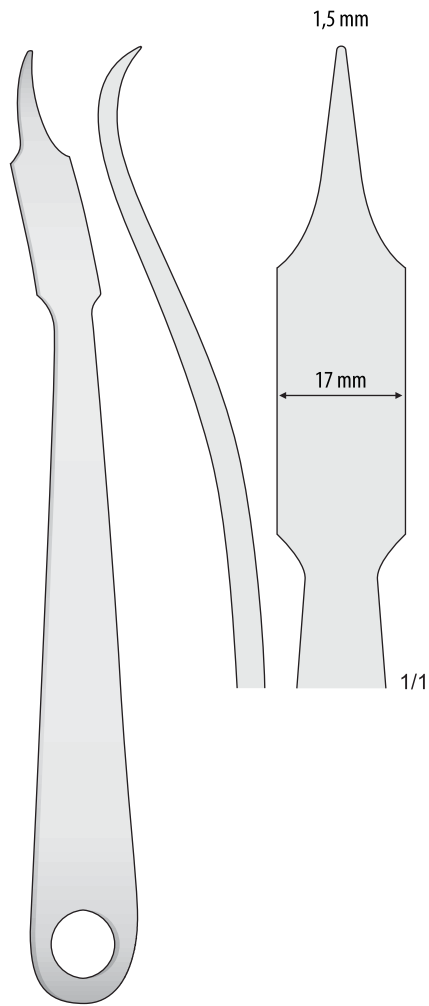

**WIS-FK-52**

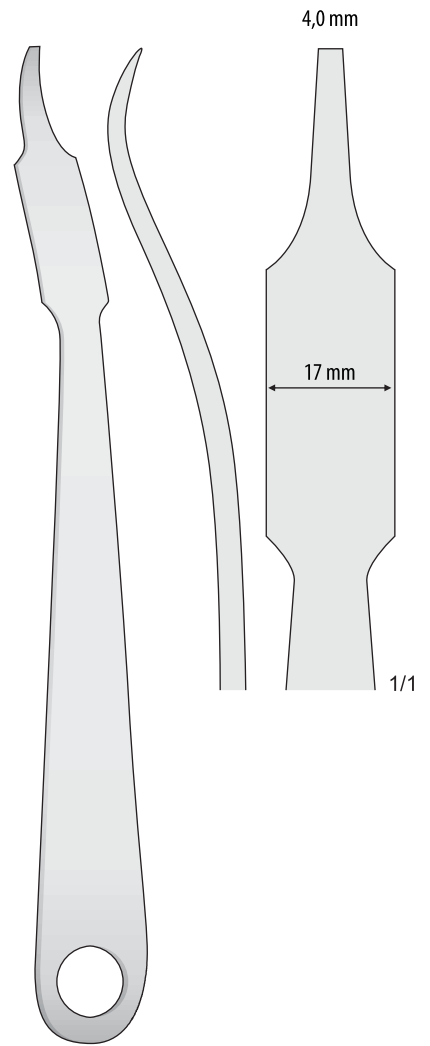

**WIS-FK-53**  
240 mm



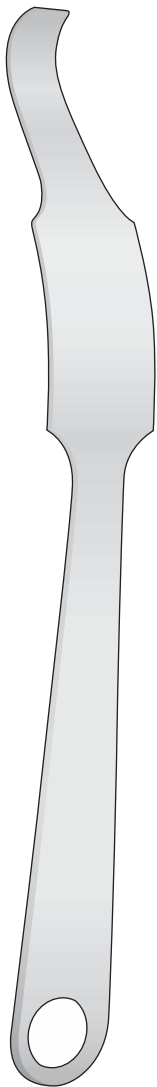

**HOHMANN**  
**WIS-FK-54/WIS-FK-55**

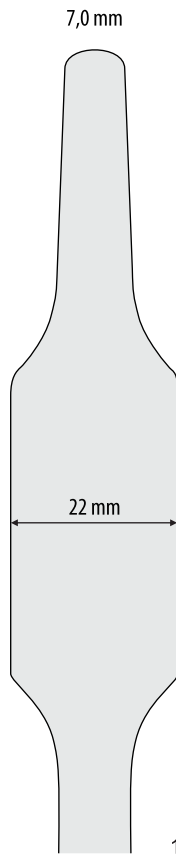
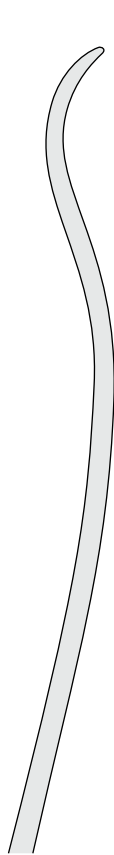

**WIS-FK-54**  
260 mm

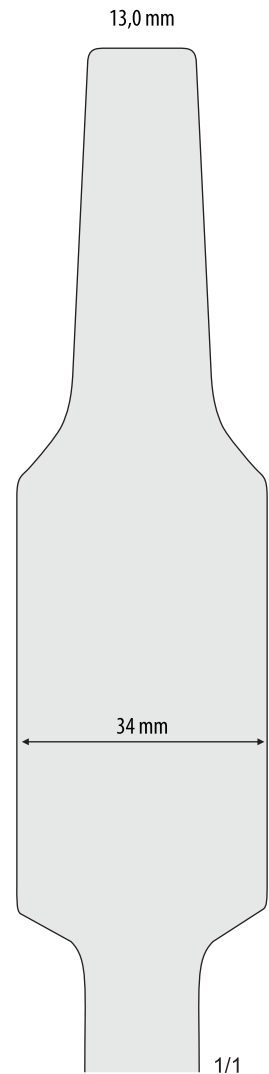
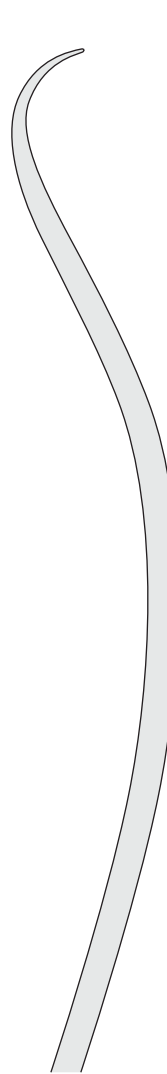

**WIS-FK-55**  
285 mm

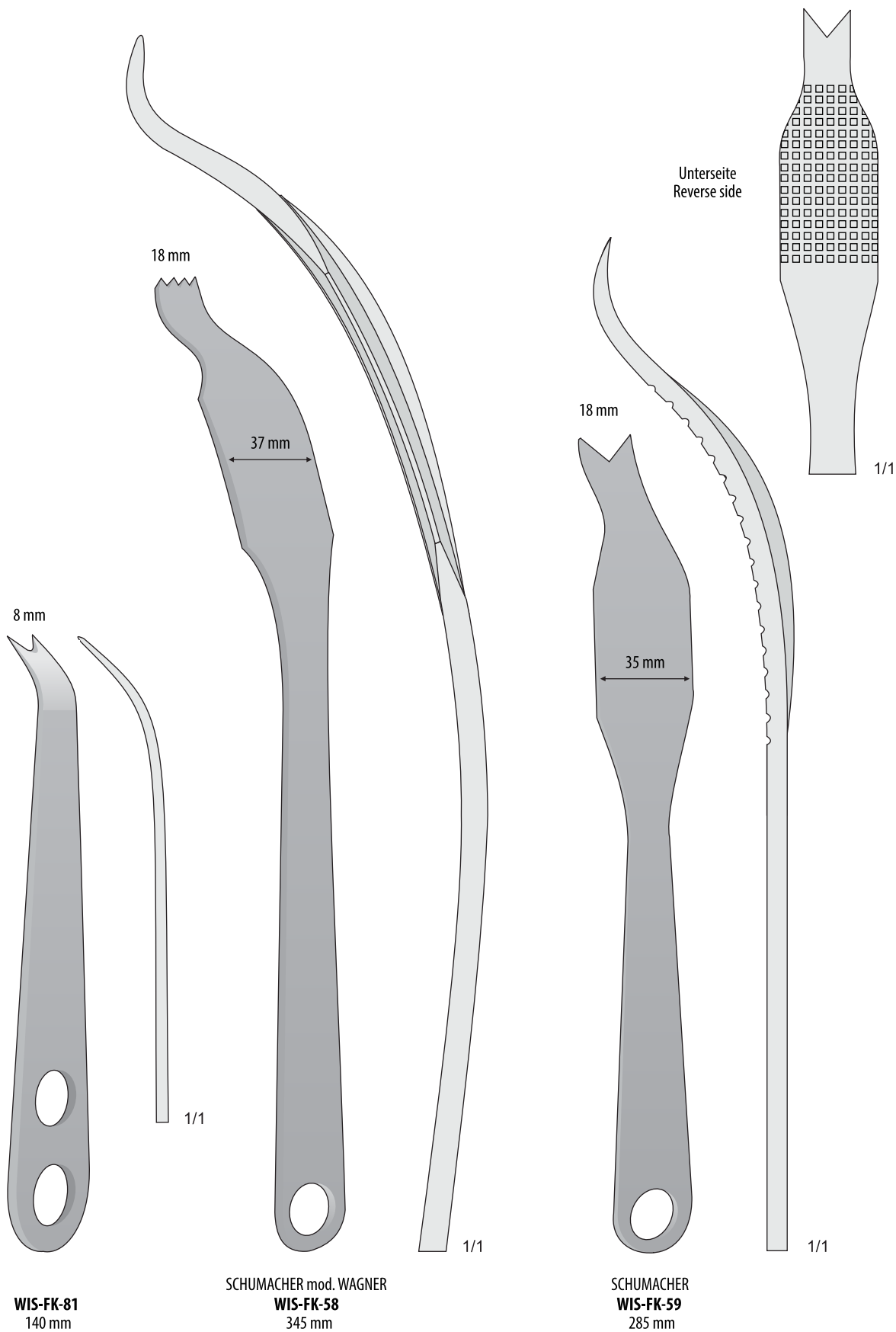

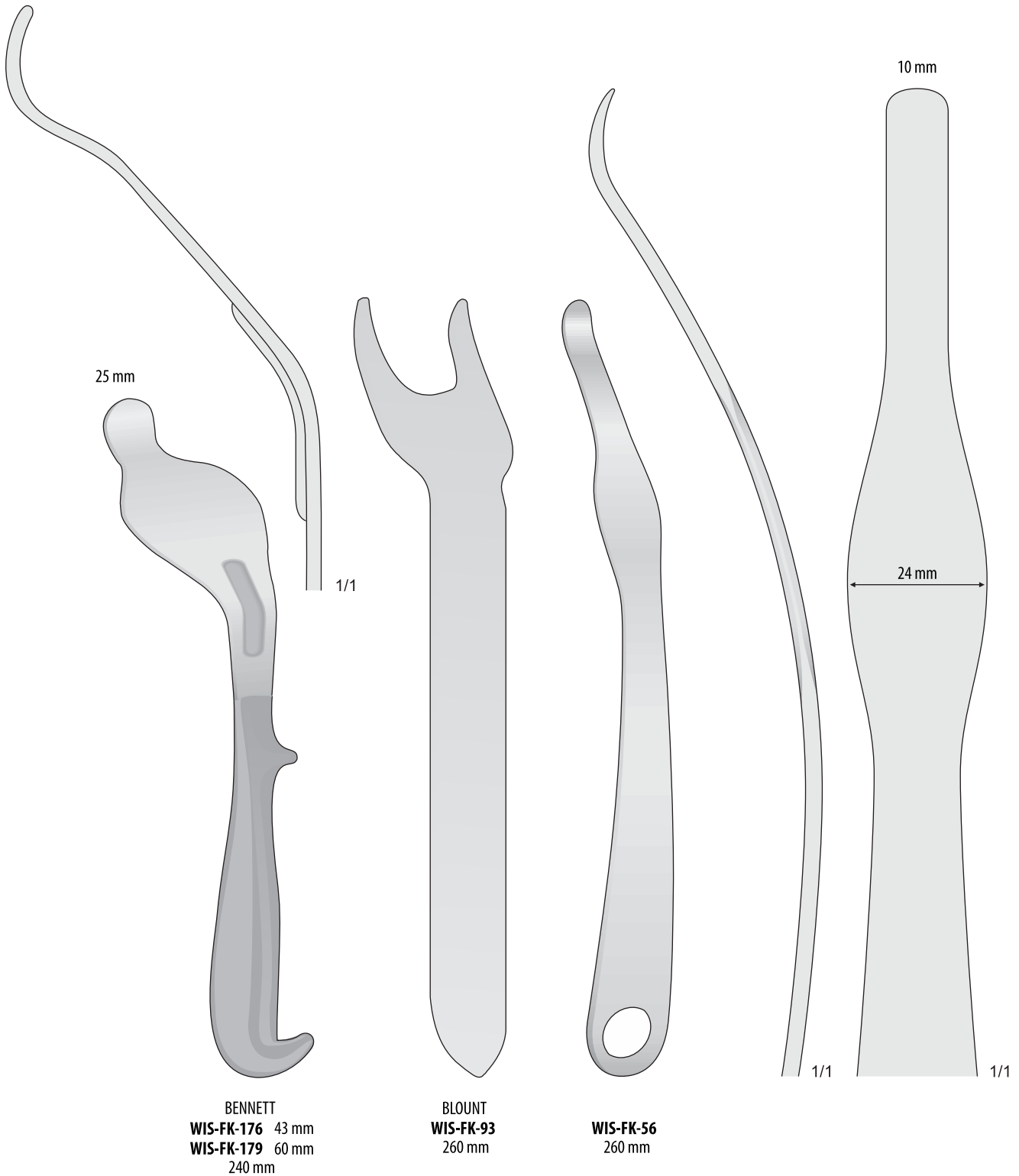

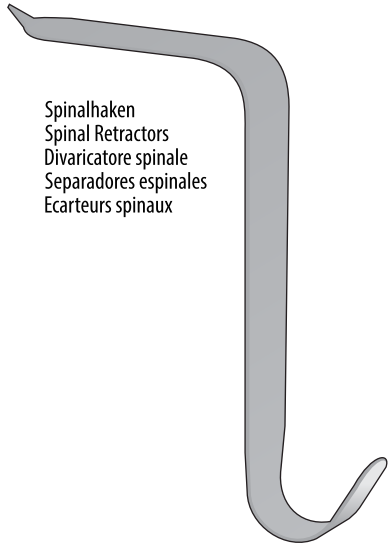

Spinalhaken  
Spinal Retractors  
Divaricatore spinale  
Separadores espinales  
Ecarteurs spinaux

TAYLOR  
**WIS-FK-168** 75 x 30 mm  
**WIS-FK-169** 100 x 30 mm  
165 mm

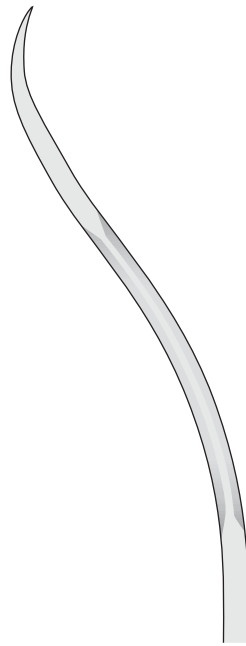

1/1

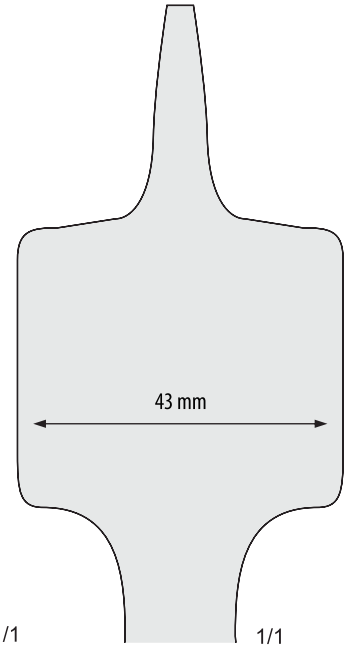

1/1

**WIS-FK-57**  
240 mm



**WIS-FK-164**  
250 mm

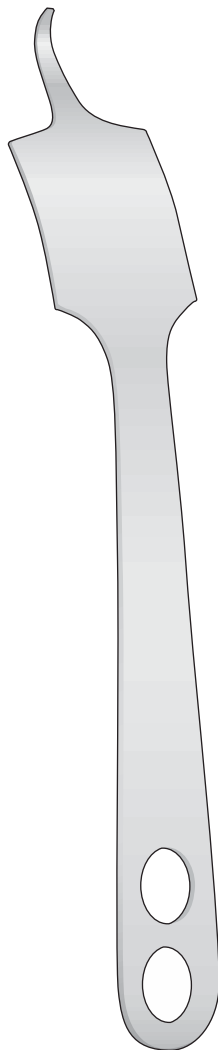
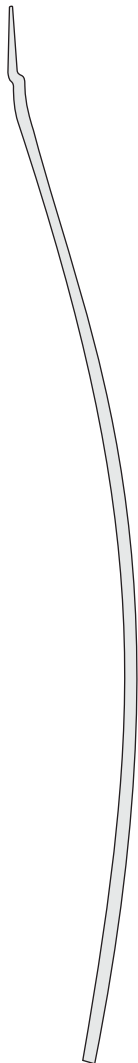

HOHMANN  
**WIS-FK-47/WIS-FK-57**  
240 mm

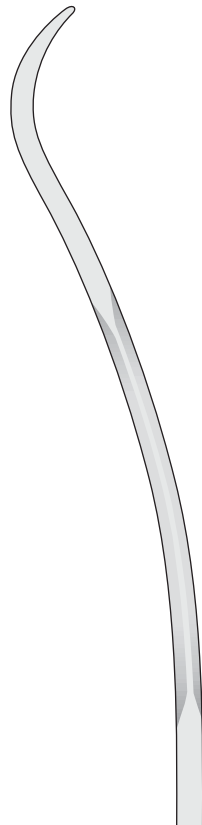

1/1

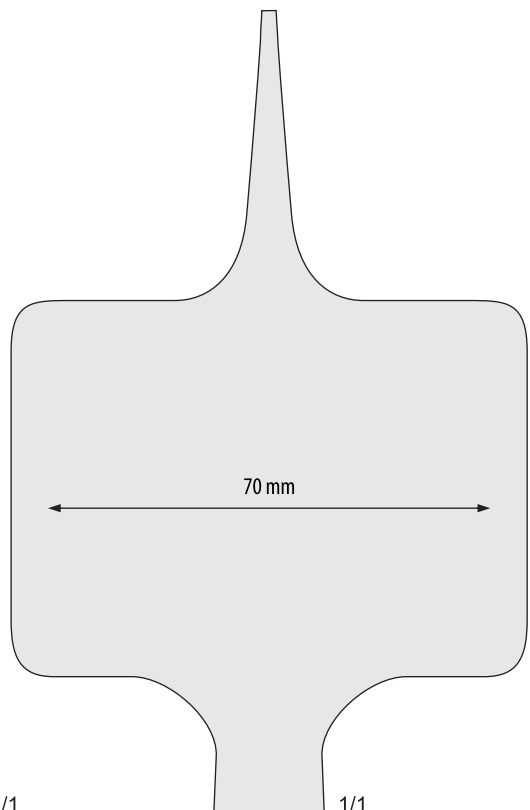

1/1

**WIS-FK-47**  
240 mm

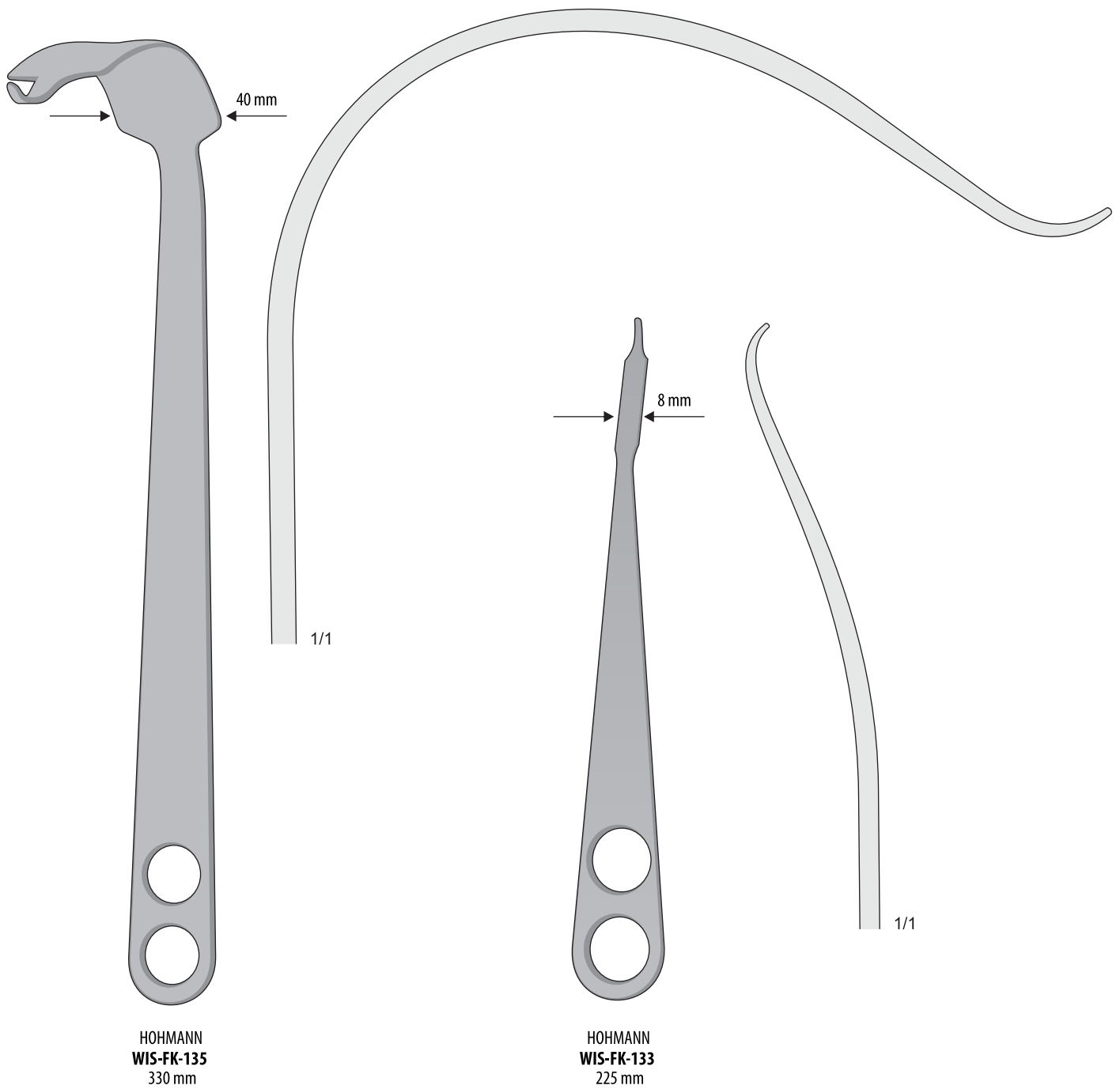

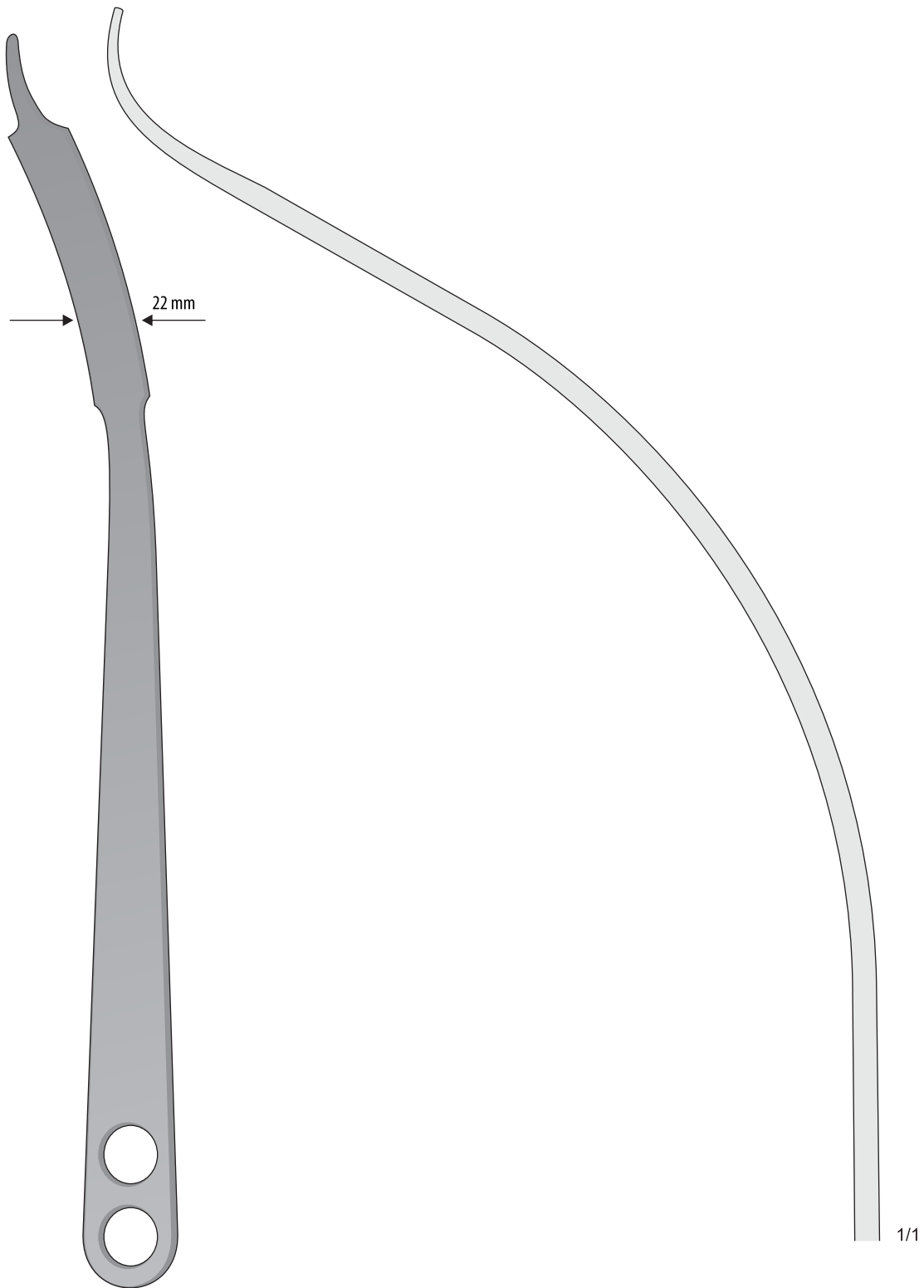

HOHMANN  
**WIS-FK-134**  
400 mm

1/1



15 mm

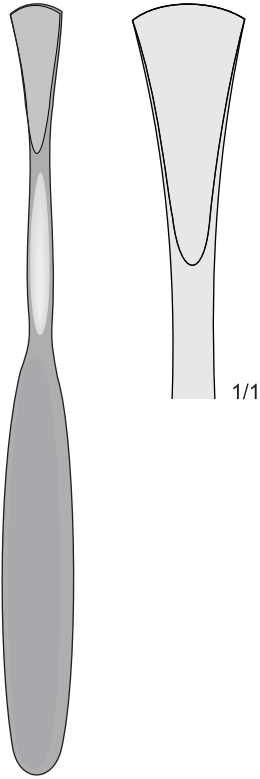

CUSHING  
WIS-FK-252  
190 mm

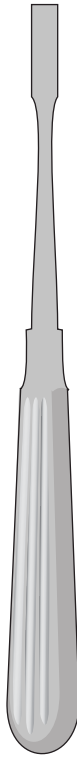

ADSON  
WIS-FK-260/WIS-FK-263  
170 mm

8 mm

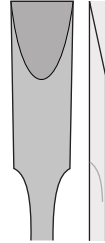

WIS-FK-260

7 mm



WIS-FK-261

7 mm



WIS-FK-262

7 mm

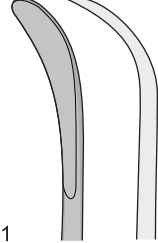

WIS-FK-263

2,5 mm

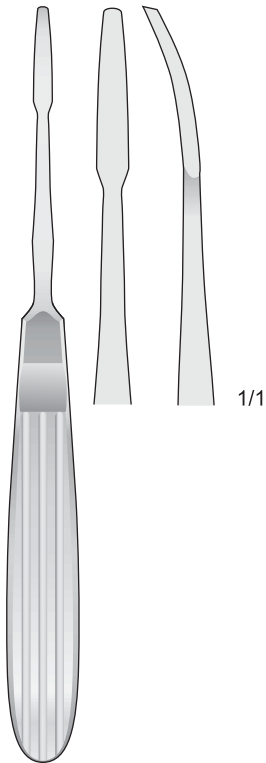

JOSEPH  
WIS-FK-80  
170 mm

4 mm

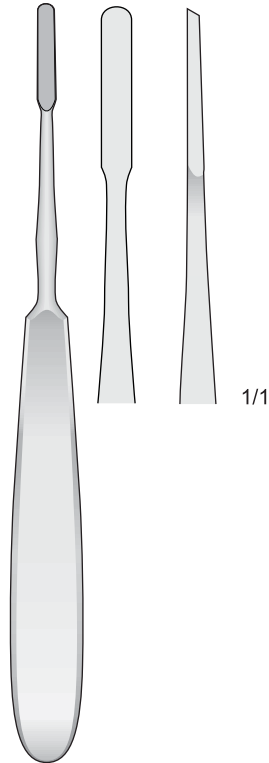

FOMON  
WIS-FK-264  
170 mm

4 mm

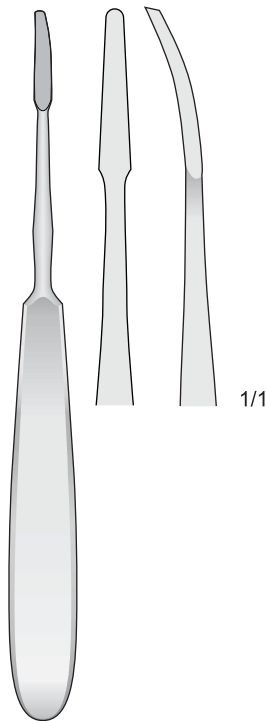

JOSEPH  
WIS-FK-265  
160 mm

7 mm

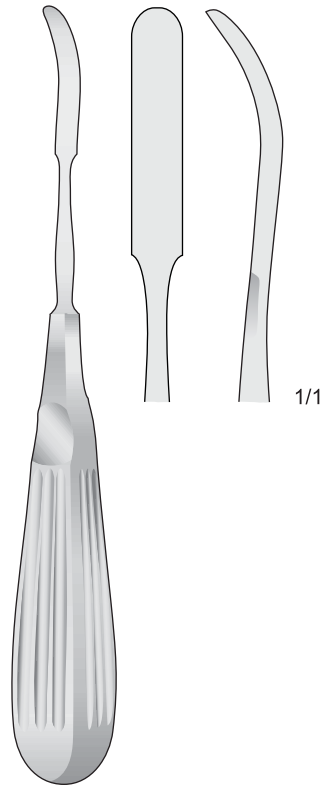

JOSEPH  
WIS-FK-82  
180 mm

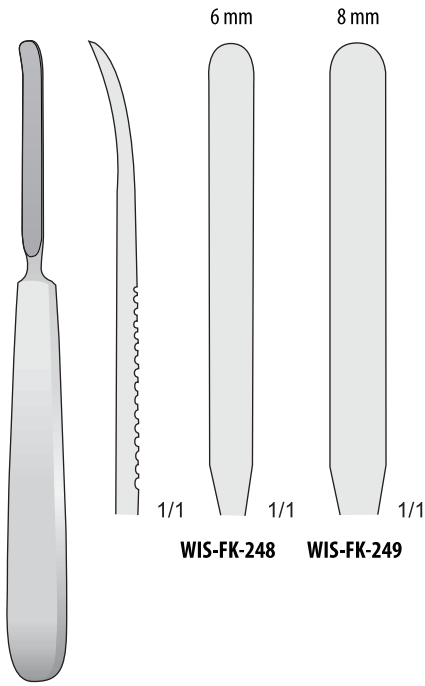

**WIS-FK-248 WIS-FK-249**

**WIS-FK-248/WIS-FK-249**  
170 mm

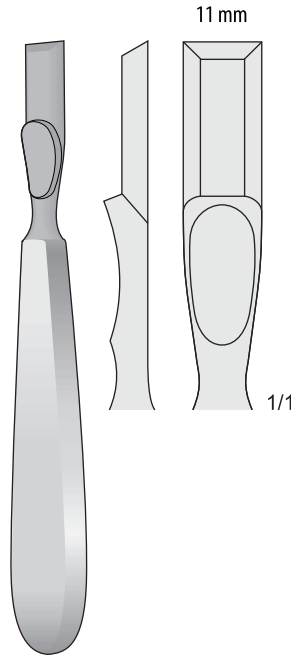

**FARABEUF-COLLIN**  
**WIS-FK-247**  
160 mm

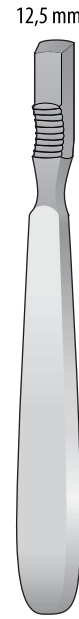

**FARABEUF**  
**WIS-FK-250**  
150 mm

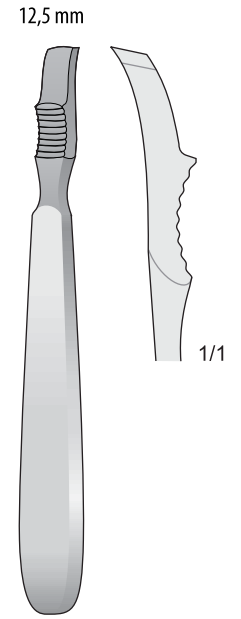

**FARABEUF**  
**WIS-FK-251**  
150 mm

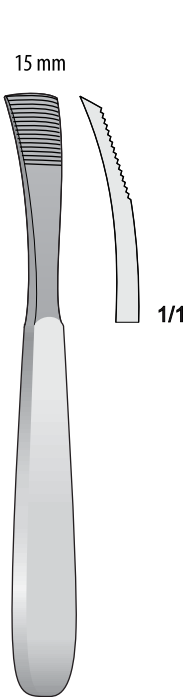

**JANSEN**  
**WIS-FK-255**  
165 mm

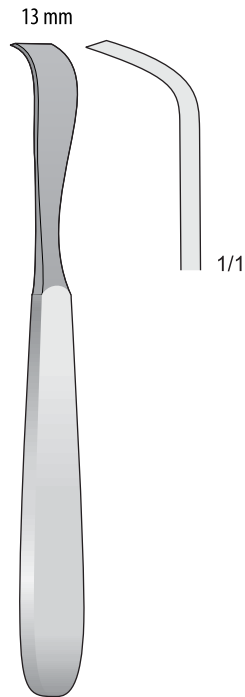

**SCHNEIDER**  
**WIS-FK-258**  
175 mm

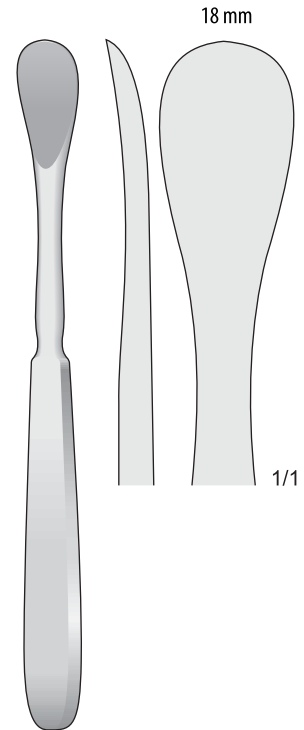

**SEDILLOT**  
**WIS-FK-254**  
185 mm

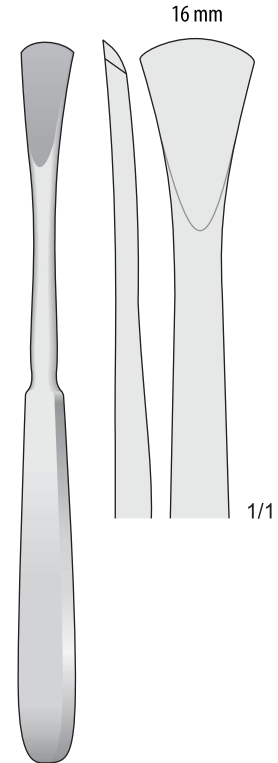

**LANGENBECK**  
**WIS-FK-256**  
190 mm

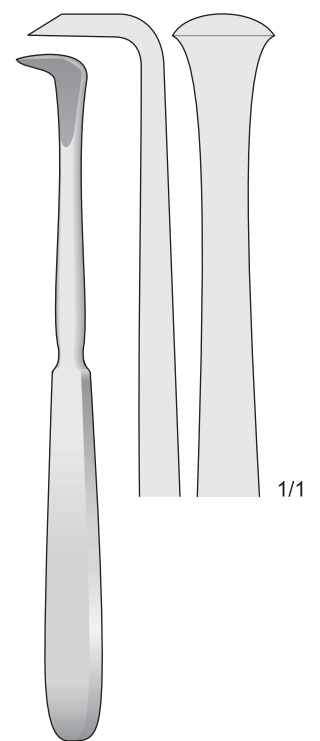

**LANGENBECK**  
**WIS-FK-257**  
180 mm



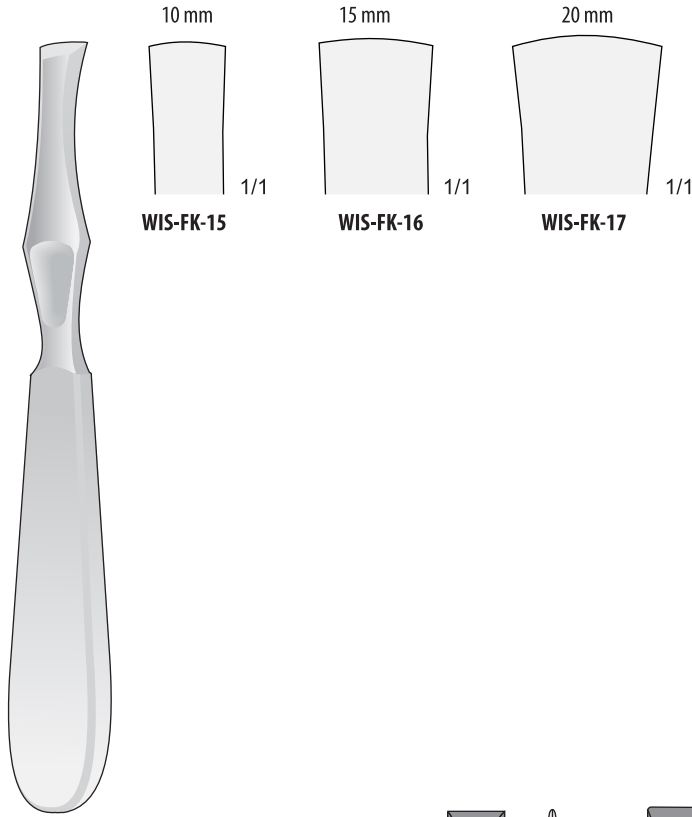

LAMBOTTE  
WIS-FK-15/WIS-FK-17  
205 mm

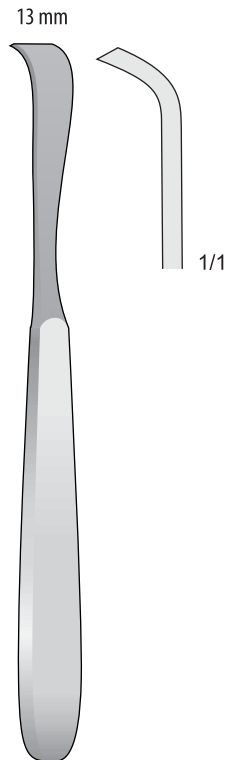

SCHNEIDER-SAUERBRUCH  
WIS-FK-259  
190 mm

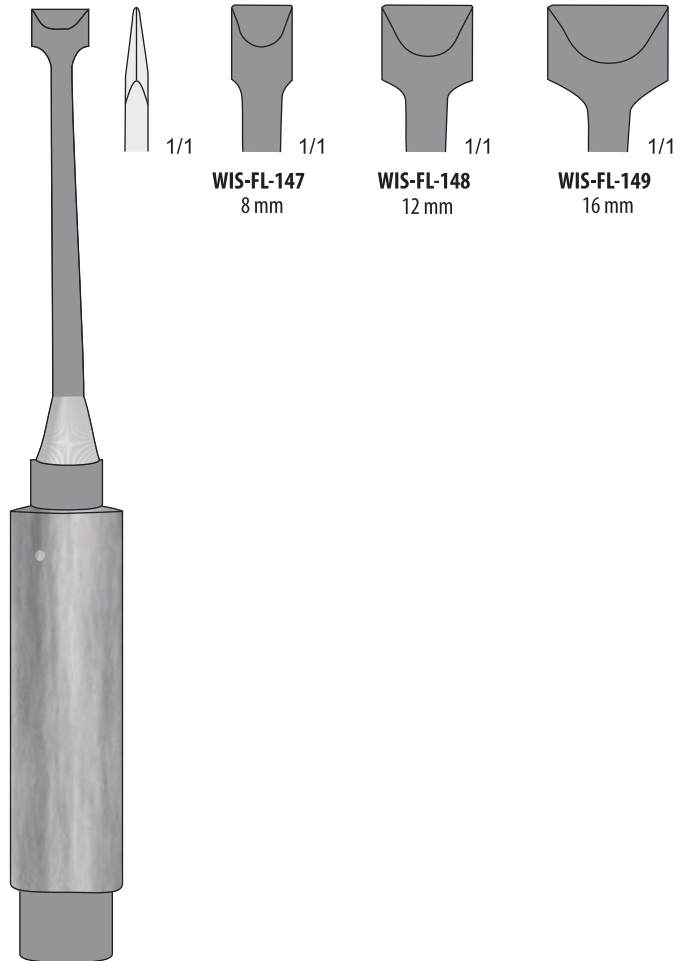

OBWEGESER  
WIS-FL-147/WIS-FL-149  
220 mm

Mit Ferrozellgri?  
With Ferrozell handle  
Con manico Ferrozell  
Con mango de Ferrozell  
Avec poignée en Ferrozell

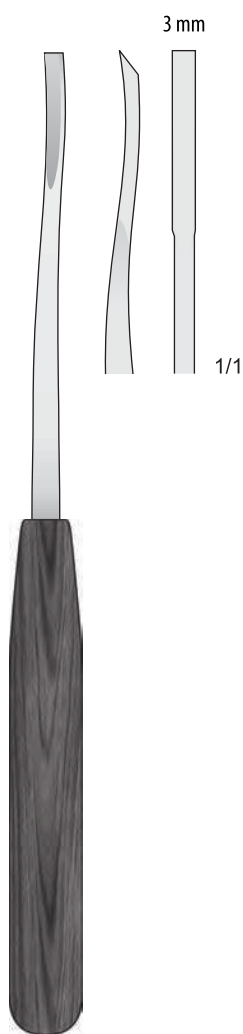

**WIS-FK-234**  
180 mm

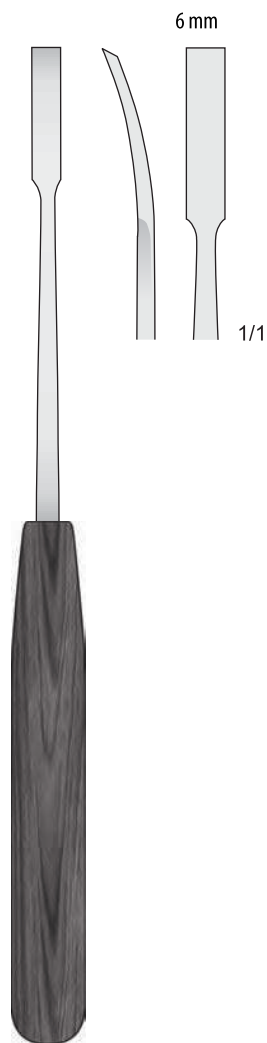

**WIS-FK-230**  
190 mm

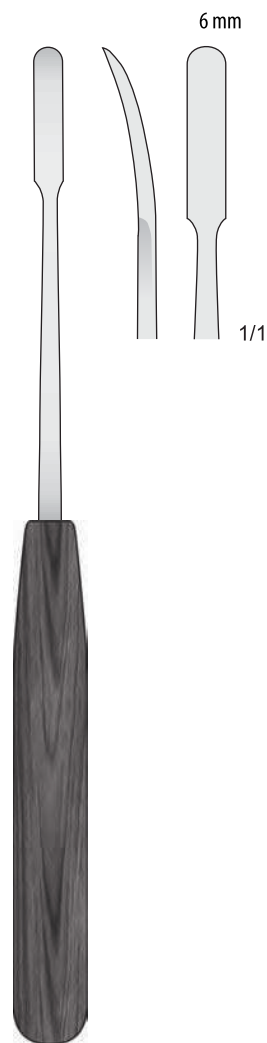

**WIS-FK-232**  
190 mm

Mit Ferrozellgriff  
With Ferrozell handle  
Con manico Ferrozell  
Con mango de Ferrozell  
Avec poignée en Ferrozell

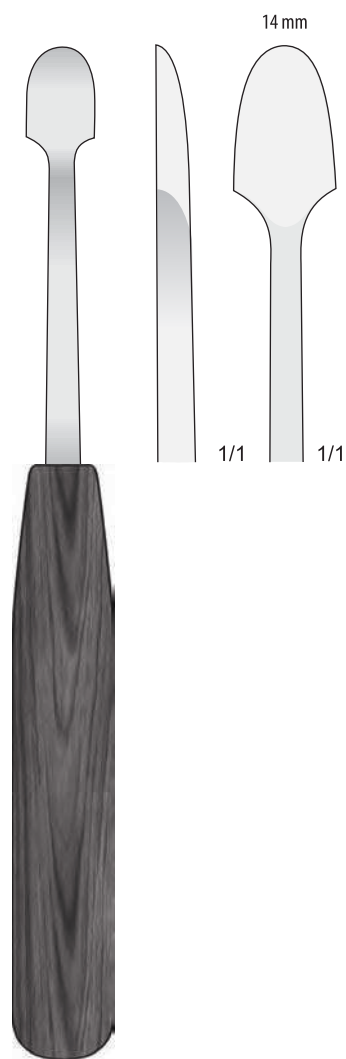

**WIS-FK-236**  
200 mm

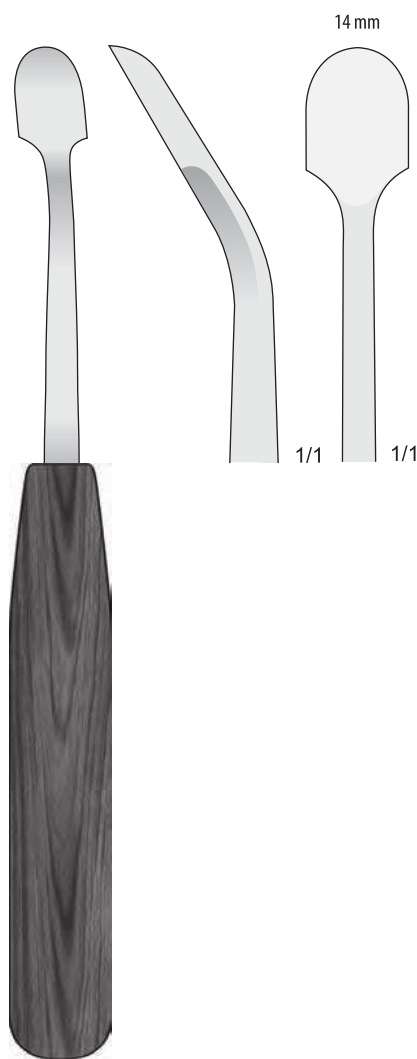

**WIS-FK-238**  
200 mm

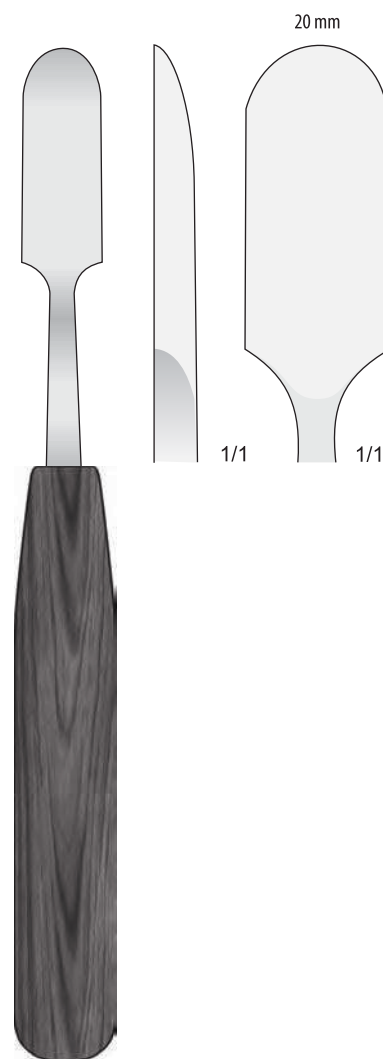

**WIS-FK-240**  
200 mm

Mit Ferrozellgri?  
With Ferrozell handle  
Con manico Ferrozell  
Con mango de Ferrozell  
Avec poign?e en Ferrozell

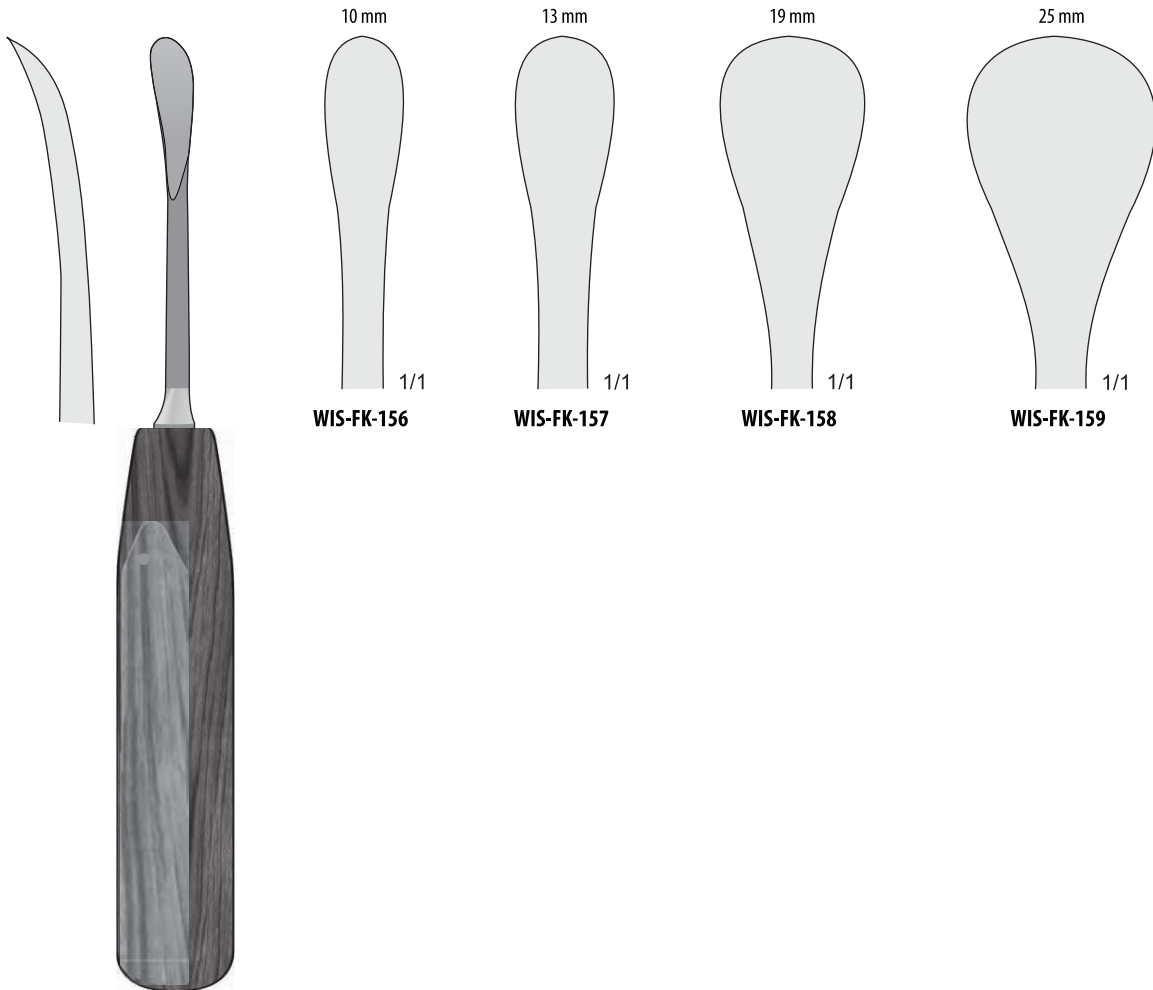

COBB  
WIS-FK-156/WIS-FK-159  
250 mm

Fig. 67

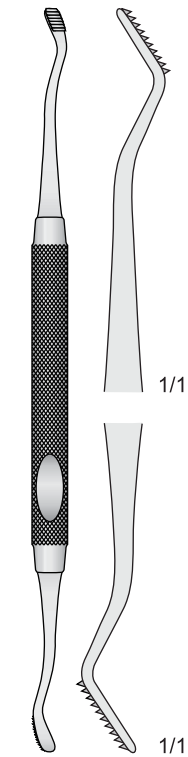

HOWARD  
WIS-DO-1  
180 mm

Fig. 45

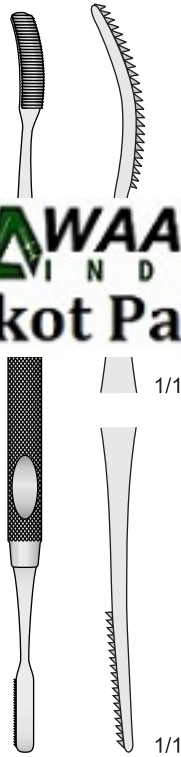

MILLER  
WIS-DO-2  
185 mm

Fig. 52

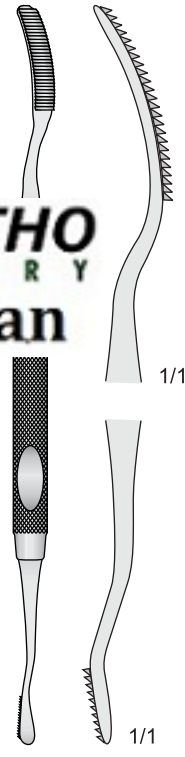

MILLER  
WIS-DO-3  
180 mm

**WAAWAA** ORTHO  
INDUSTRY  
Sialkot Pakistan

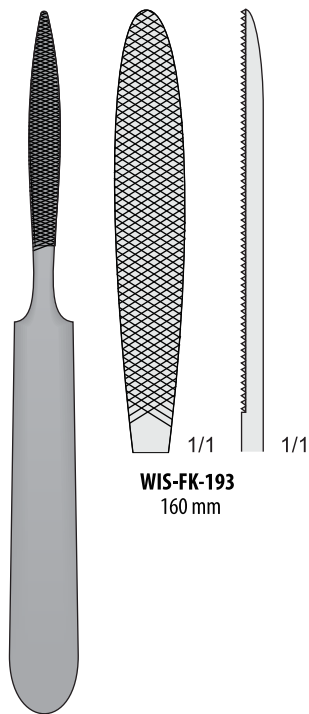

JOSEPH  
WIS-FK-193  
160 mm

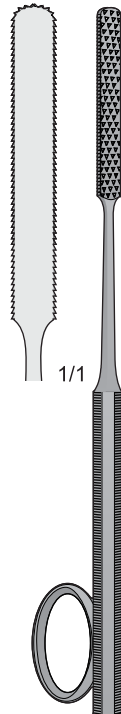

GALLAHER  
WIS-FK-194/WIS-FK-196  
160 mm

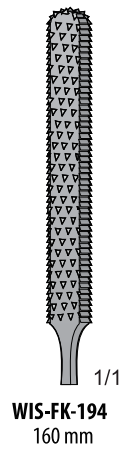

WIS-FK-194  
160 mm

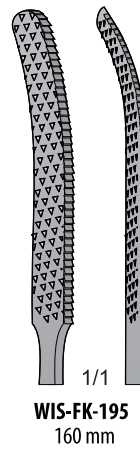

WIS-FK-195  
160 mm

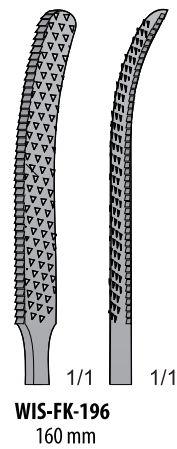

WIS-FK-196  
160 mm

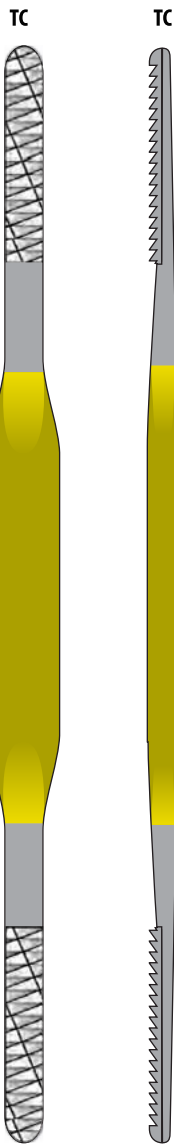

FOMON  
WIS-DO-79/WIS-DO-83  
200 mm

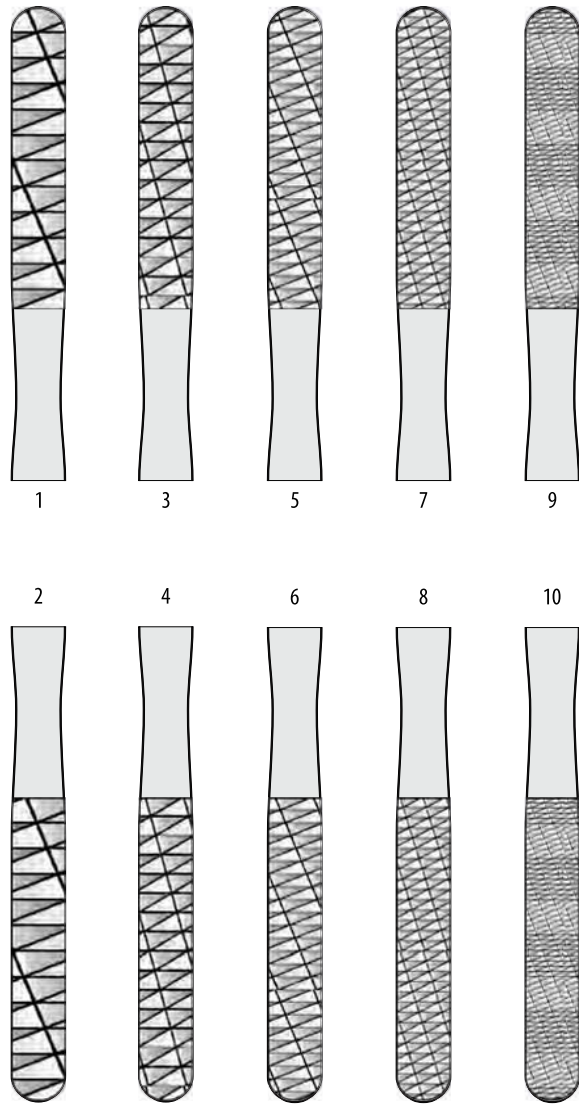

WIS-DO-79    WIS-DO-80    WIS-DO-81    WIS-DO-82    WIS-DO-83

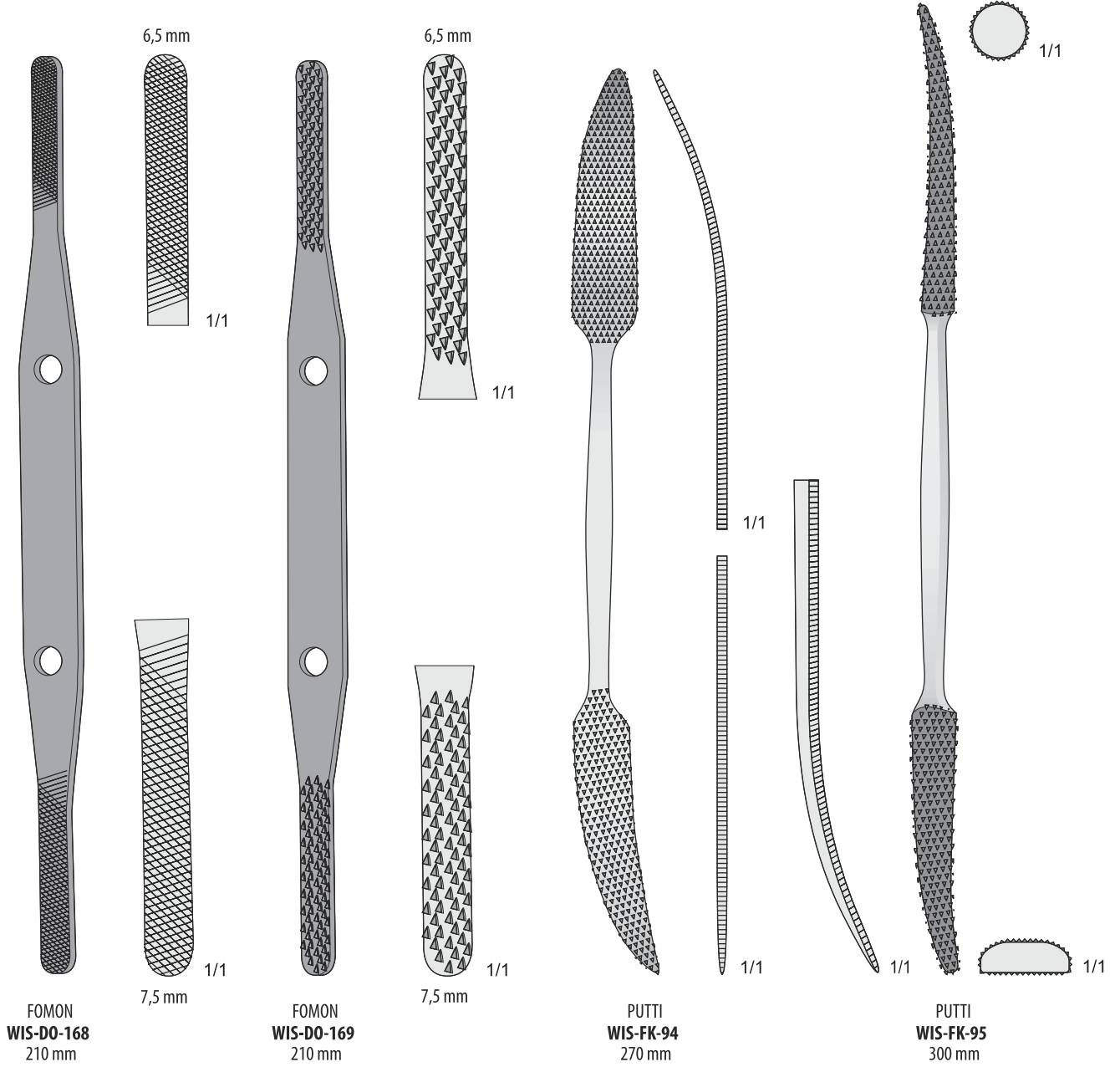



**WIS-FK-85**  
295 mm

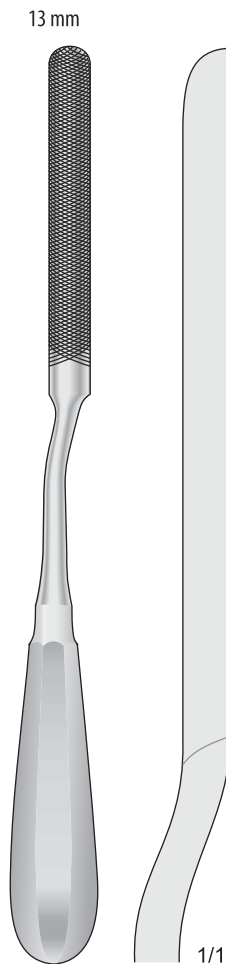

**WIS-FK-86**  
240 mm

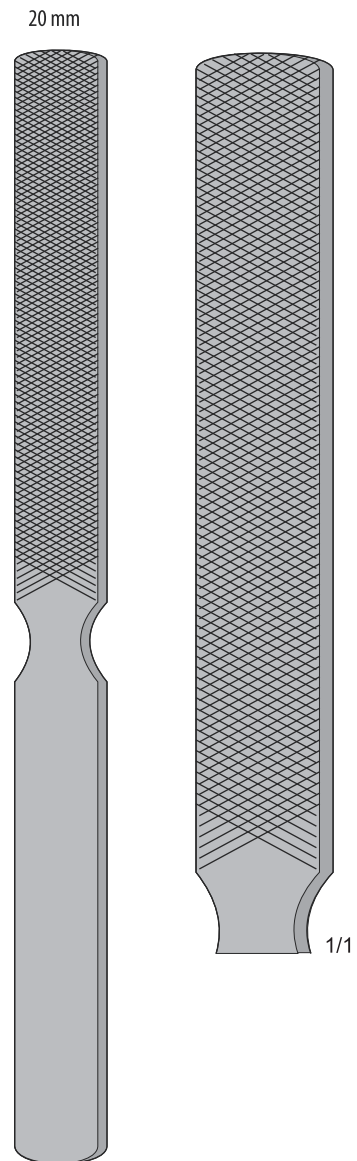

**WIS-FK-119**  
220 mm



Scharfe Küretten

Sharp curettes

Curette taglienti

Cucharillas cortantes

Curettes tranchantes

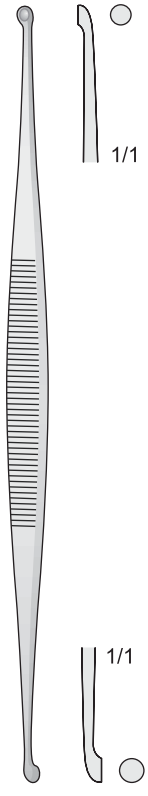

MARTINI  
WIS-FK-70  
140 mm



WILLIGER  
WIS-FK-71  
145 mm



JACOBSON  
WIS-FK-75  
140 mm



MARTINI  
-FK-7WIS  
140 mm

**WAA**WAA**ORTHO**  
INDUSTRY  
Sialkot Pakistan

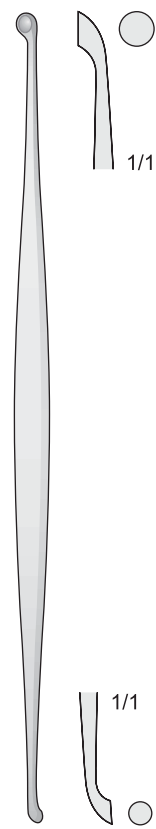

JANSEN  
WIS-FK-78  
160 mm

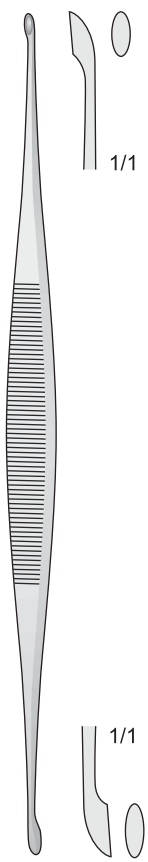

BARTH  
WIS-FK-77  
180 mm

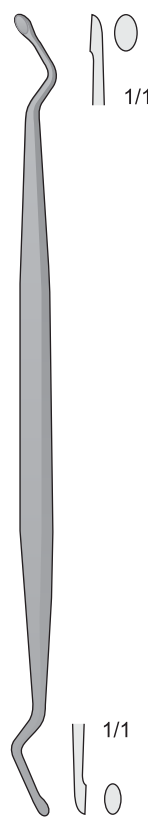

WIS-FK-83  
160 mm

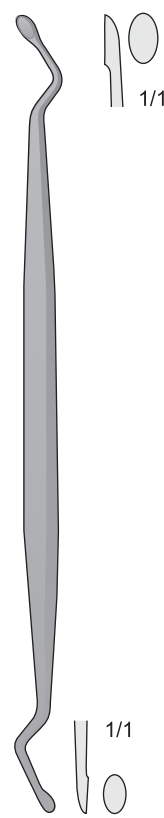

JANSEN  
WIS-FK-84  
160 mm

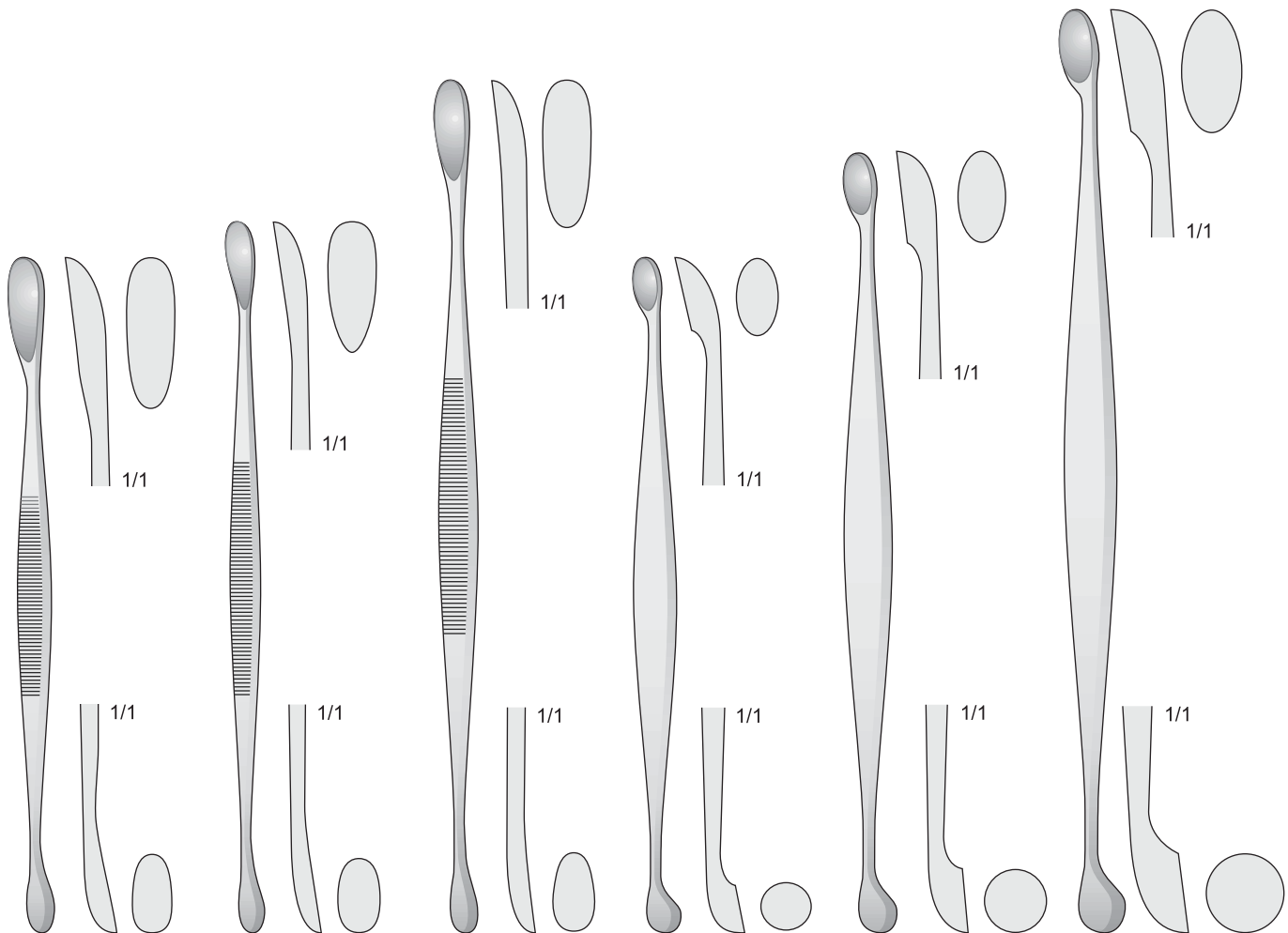

VOLKMANN  
**WIS-FK-79**  
130 mm

VOLKMANN  
**WIS-FK-72**  
145 mm

VOLKMANN  
**WIS-FK-73**

**WIS-FK-177**

**WIS-FK-74**  
160 mm

**WIS-FK-178**  
200 mm

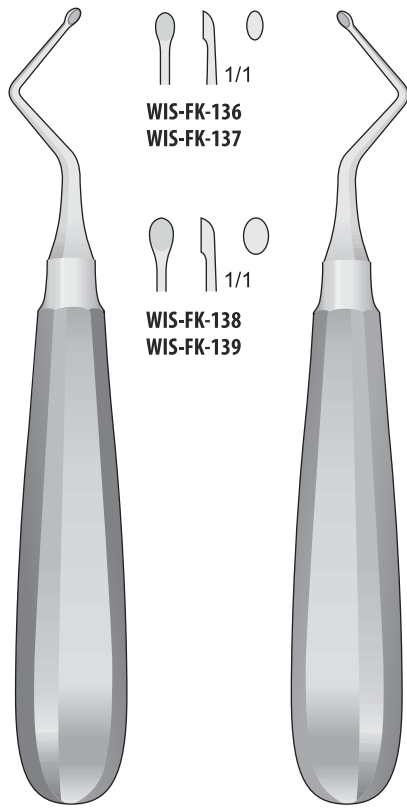

KERPEL  
WIS-FK-136  
WIS-FK-138  
145 mm

KERPEL  
WIS-FK-137  
WIS-FK-139  
145 mm

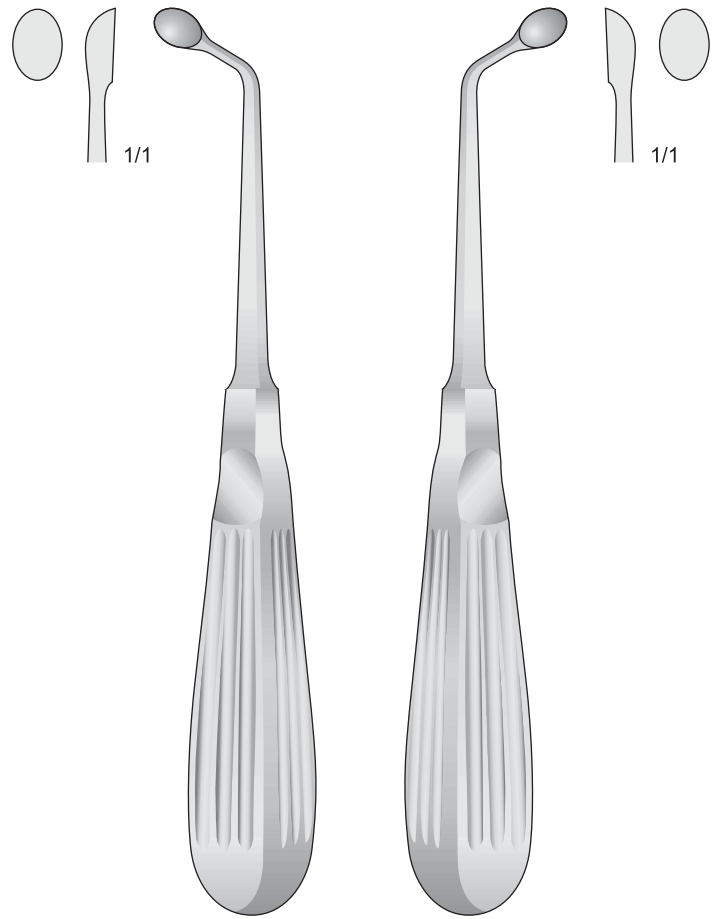

UFFENORDE  
WIS-FK-188  
170 mm

UFFENORDE  
WIS-FK-189  
170 mm

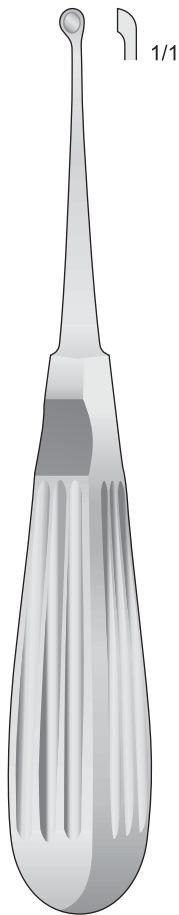

BRUNS  
WIS-FK-110/WIS-FK-116  
165 mm

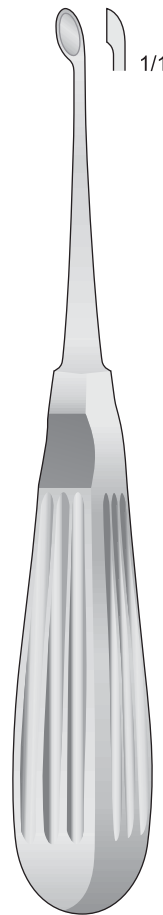
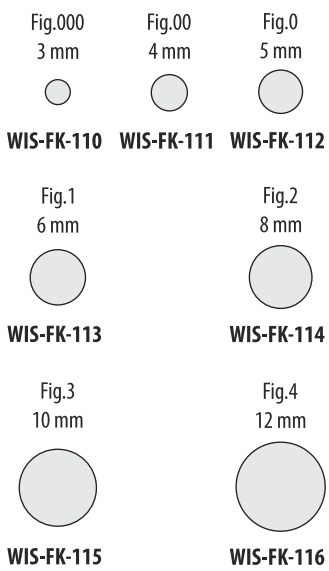

SCHEDE  
WIS-FK-120/WIS-FK-126  
170 mm

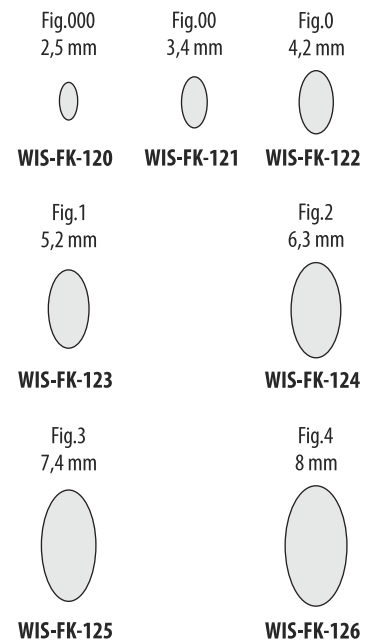

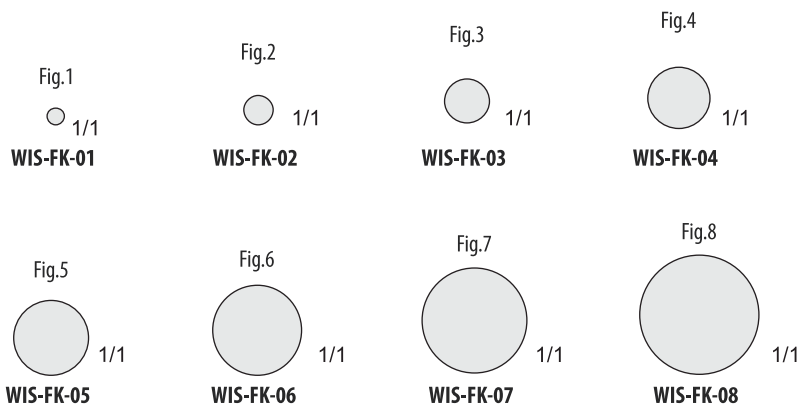
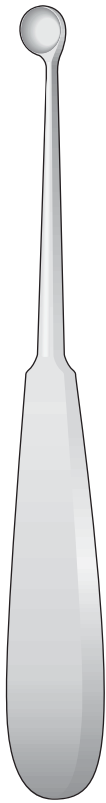

**WAAORTHO**  
INDUSTRY  
Sialkot Pakistan

WIS-FK-01/WIS-FK-08  
180 mm

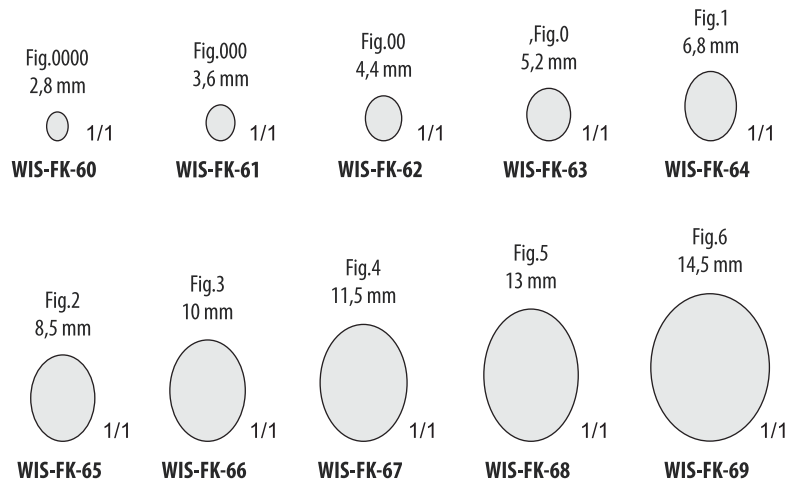
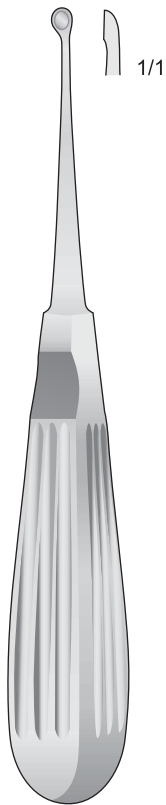

VOLKMANN  
WIS-FK-60/WIS-FK-69  
170 mm

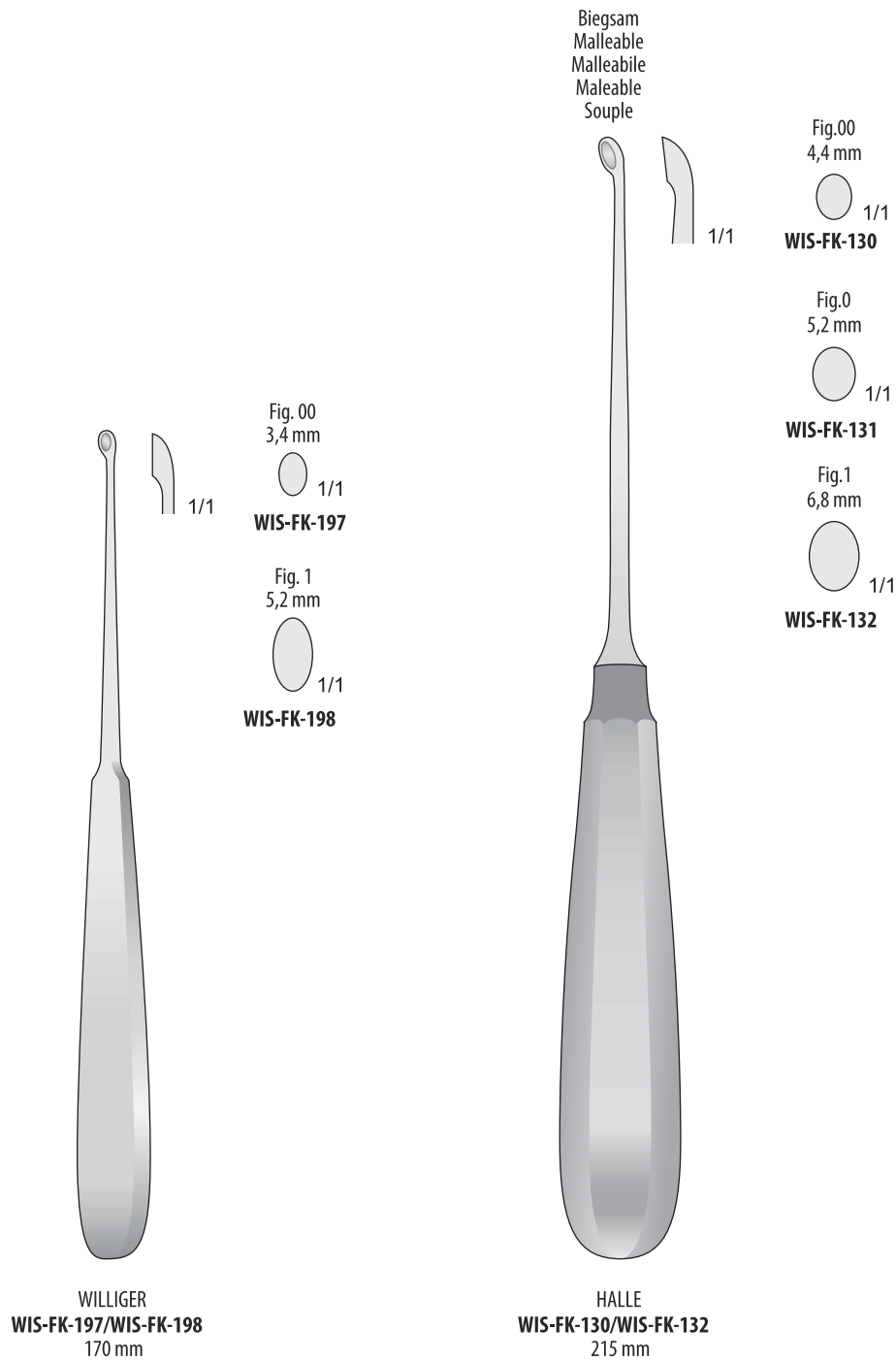

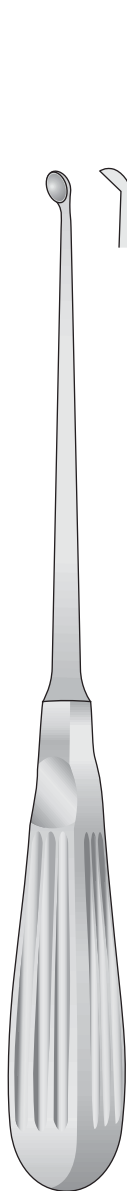

DAUBENSPECK  
WIS-FK-180/WIS-FK-183  
200 mm

- Fig.00  
2,8 mm  
1/1  
WIS-FK-180
- Fig.0  
3,8 mm  
1/1  
WIS-FK-181
- Fig.1  
5 mm  
1/1  
WIS-FK-182
- Fig.2  
6 mm  
1/1  
WIS-FK-183

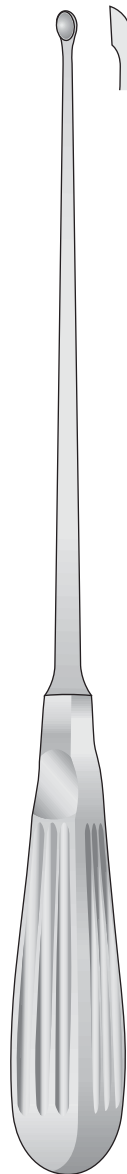

WIS-FK-160/WIS-FK-163  
250 mm

- 3,6 mm  
1/1  
WIS-FK-160
- 4,4 mm  
1/1  
WIS-FK-161
- 5,2 mm  
1/1  
WIS-FK-162
- 6 mm  
1/1  
WIS-FK-163

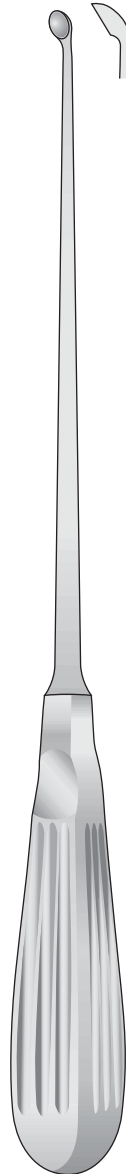

WIS-FK-170/WIS-FK-173  
250 mm

- 3,6 mm  
1/1  
WIS-FK-170
- 4,4 mm  
1/1  
WIS-FK-171
- 5,2 mm  
1/1  
WIS-FK-172
- 6 mm  
1/1  
WIS-FK-173

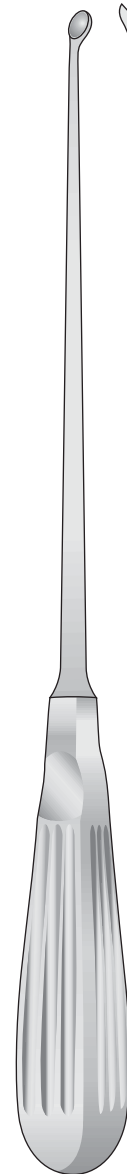

BUSHE  
WIS-FK-190/WIS-FK-192  
250 mm

- 3 mm  
1/1  
WIS-FK-190
- 4 mm  
1/1  
WIS-FK-191
- 5 mm  
1/1  
WIS-FK-192

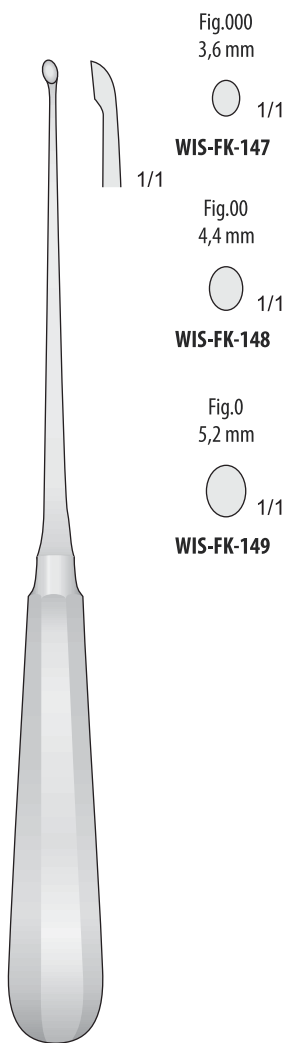

SIMON  
WIS-FK-147/WIS-FK-149  
235 mm

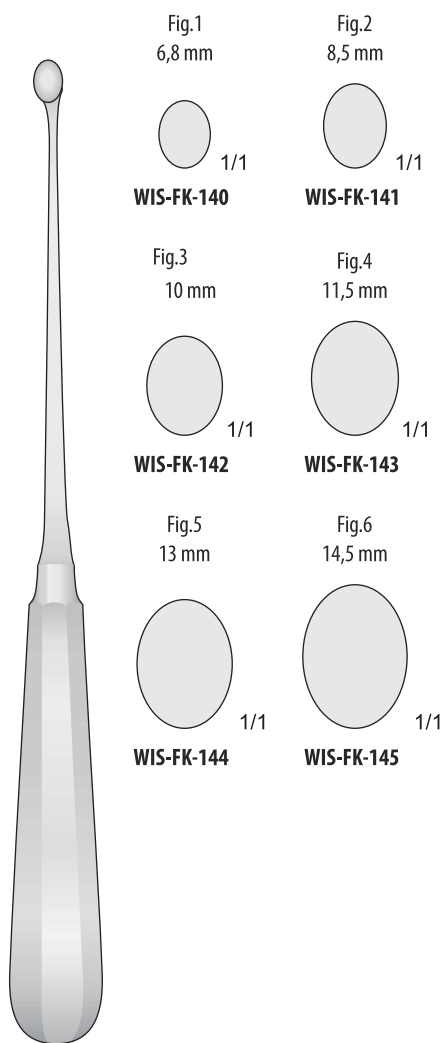

SIMON  
WIS-FK-140/WIS-FK-145  
240 mm

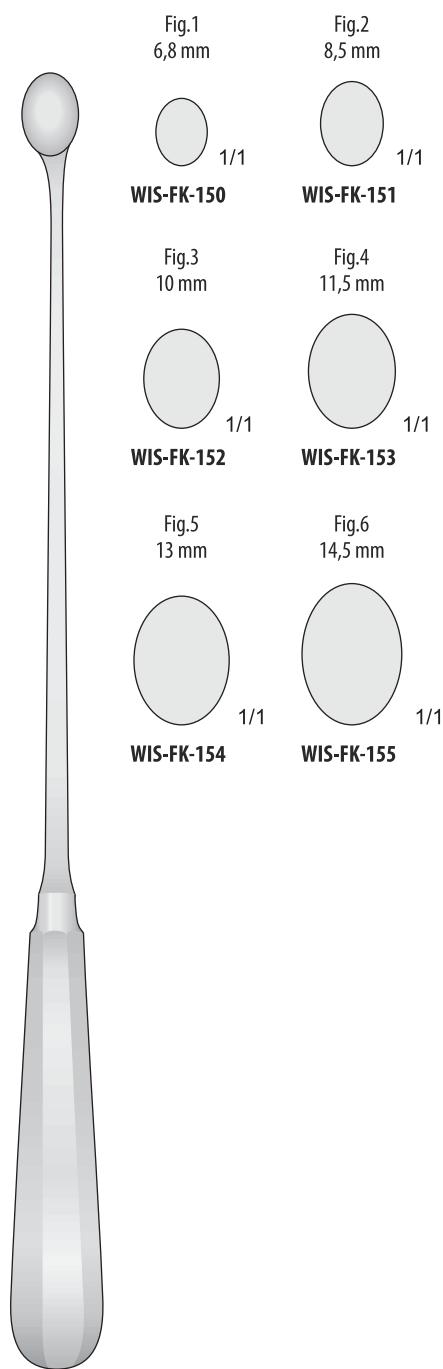

SCHR?DER  
WIS-FK-150/WIS-FK-155  
310 mm



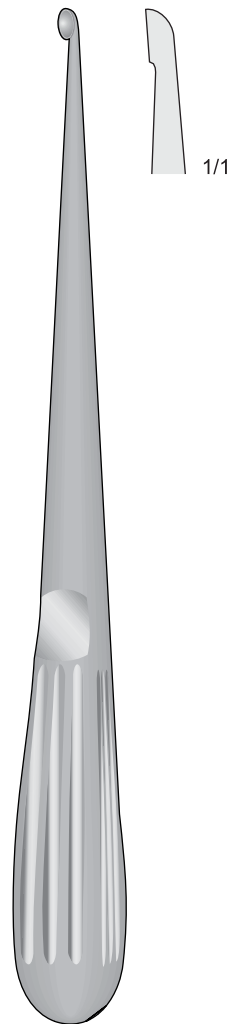

- |   |   |   |   |
|---|---|---|---|
| <p>Fig.5/0<br/>2,2 mm</p> <p>○ 1/1</p> <p><b>WIS-FK-280</b></p> | <p>Fig.4/0<br/>2,5 mm</p> <p>○ 1/1</p> <p><b>WIS-FK-281</b></p> | <p>Fig.3/0<br/>2,8 mm</p> <p>○ 1/1</p> <p><b>WIS-FK-282</b></p> | <p>Fig.2/0<br/>3,3 mm</p> <p>○ 1/1</p> <p><b>WIS-FK-283</b></p> |
| <p>Fig.0<br/>3,6 mm</p> <p>○ 1/1</p> <p><b>WIS-FK-284</b></p>   | <p>Fig.1<br/>4,3 mm</p> <p>○ 1/1</p> <p><b>WIS-FK-285</b></p>   | <p>Fig.2<br/>4,8 mm</p> <p>○ 1/1</p> <p><b>WIS-FK-286</b></p>   | <p>Fig.3<br/>5,6 mm</p> <p>○ 1/1</p> <p><b>WIS-FK-287</b></p>   |
| <p>Fig.4<br/>6,0 mm</p> <p>○ 1/1</p> <p><b>WIS-FK-288</b></p>   | <p>Fig.5<br/>6,7 mm</p> <p>○ 1/1</p> <p><b>WIS-FK-289</b></p>   | <p>Fig.6<br/>8,8 mm</p> <p>○ 1/1</p> <p><b>WIS-FK-290</b></p>   |   |

BRUNS  
WIS-FK-280/WIS-FK-290  
170 mm

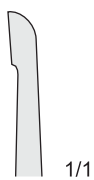
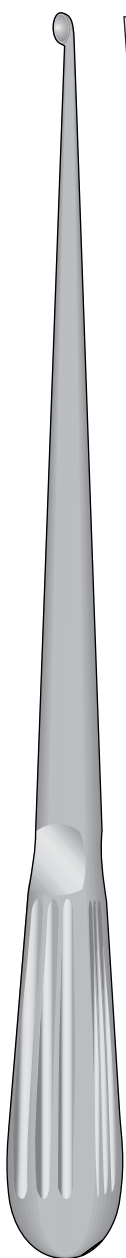

Fig.3/0  
2,8 mm



1/1

WIS-FK-291

Fig.2/0  
3,3 mm



1/1

WIS-FK-292

Fig.0  
3,6 mm



1/1

WIS-FK-293

Fig.1  
4,3 mm



1/1

WIS-FK-294

Fig.2  
4,8 mm



1/1

WIS-FK-295

Fig.3  
5,6 mm



1/1

WIS-FK-296

Fig.4  
6,0 mm



1/1

WIS-FK-297

Fig.5  
6,7 mm



1/1

WIS-FK-298

Fig.6  
8,8 mm



1/1

WIS-FK-299

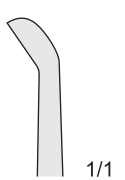
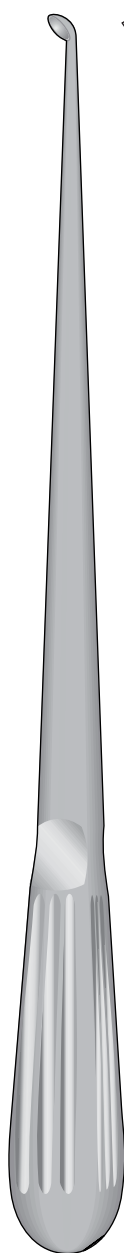

Fig.3/0  
2,8 mm



1/1

WIS-FK-300

Fig.2/0  
3,3 mm



1/1

WIS-FK-301

Fig.0  
3,6 mm



1/1

WIS-FK-302

Fig.1  
4,3 mm



1/1

WIS-FK-303

Fig.2  
4,8 mm



1/1

WIS-FK-304

Fig.3  
5,6 mm



1/1

WIS-FK-305

Fig.4  
6,0 mm



1/1

WIS-FK-306

Fig.5  
6,7 mm



1/1

WIS-FK-307

Fig.6  
8,8 mm



1/1

WIS-FK-308

BRUNS  
WIS-FK-291/WIS-FK-299  
225 mm

BRUNS  
WIS-FK-300/WIS-FK-308  
225 mm

Mit Ferrozellgrif - With Ferrozell handle  
Con manico Ferrozell - Con mango de Ferrozell  
Avec manche en Ferrozell

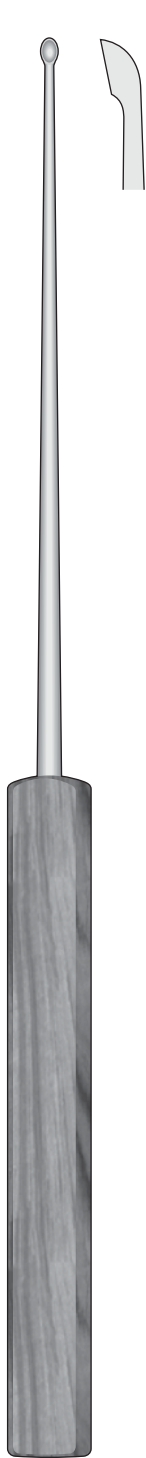

Fig.0000  
2,8 mm  
1/1  
**WIS-FK-310**

Fig.0  
5,2 mm  
1/1  
**WIS-FK-312**

Fig.000  
3,6 mm  
1/1  
**WIS-FK-311**

Fig.3  
10,0 mm  
1/1  
**WIS-FK-313**



Fig.0000  
2,8 mm  
1/1  
**WIS-FK-314**

Fig.0  
5,2 mm  
1/1  
**WIS-FK-316**

Fig.000  
3,6 mm  
1/1  
**WIS-FK-315**

Fig.3  
10,0 mm  
1/1  
**WIS-FK-317**

SYPERT  
**WIS-FK-310/WIS-FK-313**  
380 mm

SYPERT  
**WIS-FK-314/WIS-FK-317**  
380 mm

Mit Ferrozellgrif - With Ferrozell handle  
Con manico Ferrozell - Con mango de Ferrozell  
Avec poignée en Ferrozell

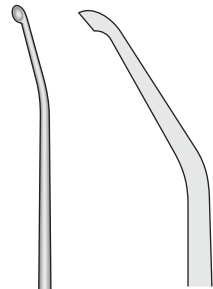

Fig.0000  
2,8 mm



**WIS-FK-318**

Fig.000  
3,6 mm



**WIS-FK-319**



SYPERT  
**WIS-FK-318/WIS-FK-319**  
420 mm



Fig.000  
3,6 mm



**WIS-FK-320**

Fig.00  
4,4 mm



**WIS-FK-321**

Fig.0  
5,2 mm



**WIS-FK-322**

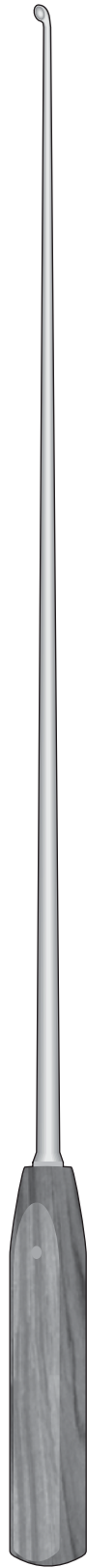

**WIS-FK-320/WIS-FK-322**  
410 mm



Fig.000  
3,6 mm



**WIS-FK-323**

Fig.00  
4,4 mm



**WIS-FK-324**

Fig.0  
5,2 mm



**WIS-FK-325**

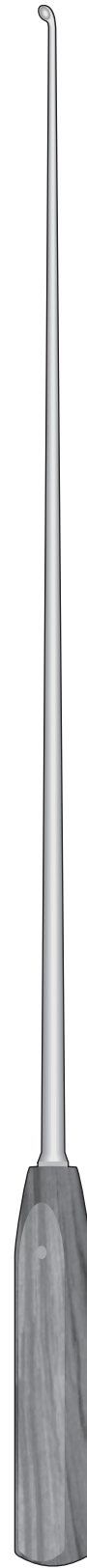

**WIS-FK-323/WIS-FK-325**  
410 mm

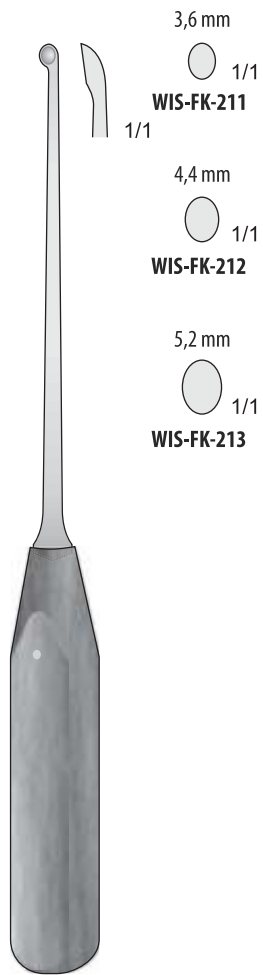

CASPAR  
WIS-FK-211/WIS-FK-213  
220 mm

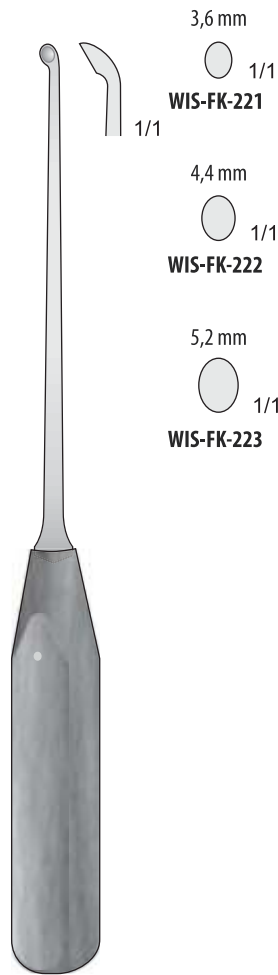

CASPAR  
WIS-FK-221/WIS-FK-223  
220 mm

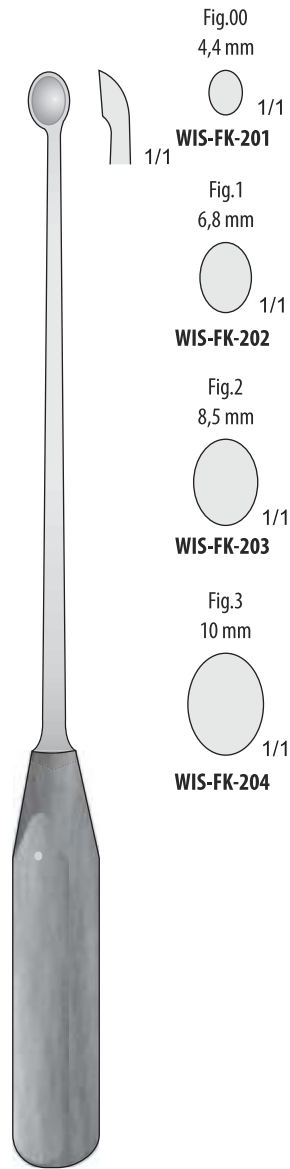

WIS-FK-201/WIS-FK-204  
270 mm



TESSIER  
WIS-FL-198  
220 mm

Femoral prosthesis instrumentation  
Strumentario per protesi femorale  
Instruments pour prothese femorale

Mit Ferrozellgriff  
With Ferrozell handle  
Con mango de Ferrozell  
Avec poign?e en Ferrozell

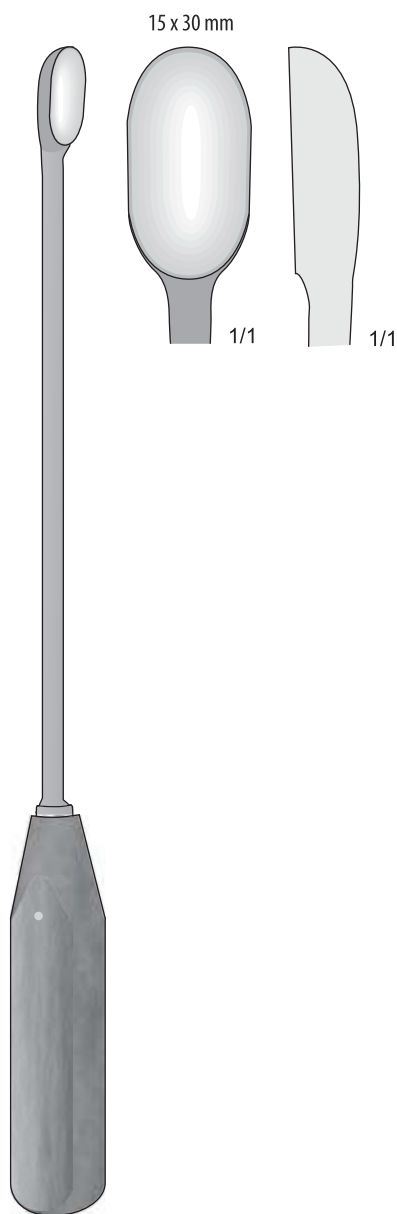

**WIS-FK-206**  
300 mm

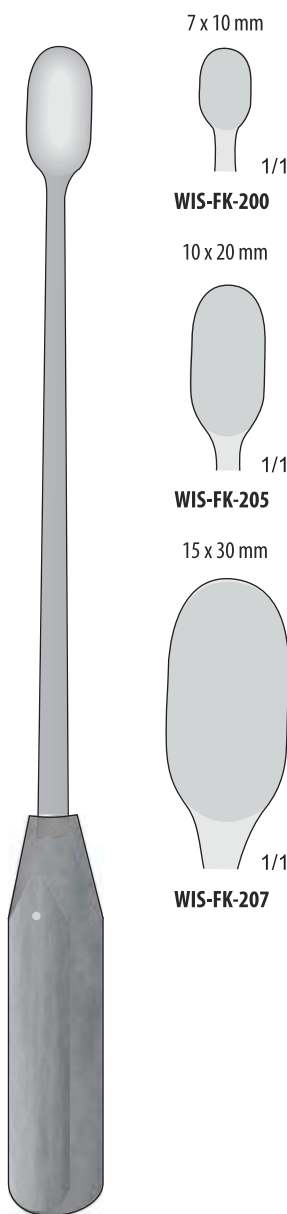

**WIS-FK-200/WIS-FK-207**  
300 mm

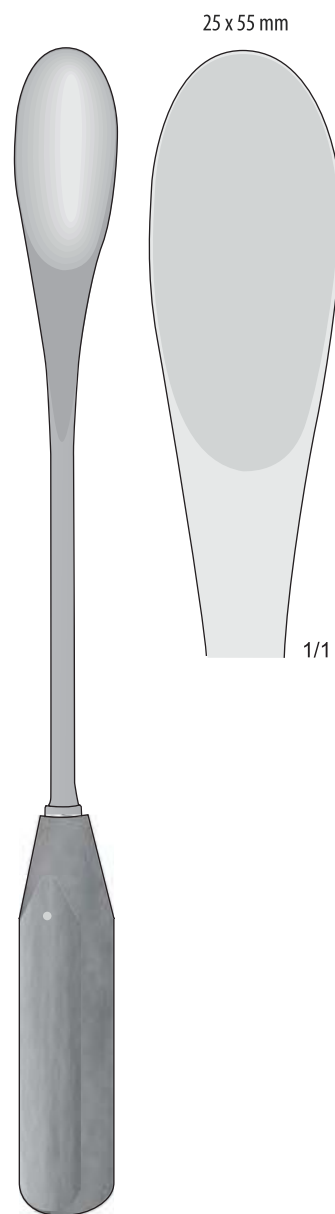

**WIS-FK-208**  
300 mm

**Surgical Mallets**

Chirurgische Hämmer  
Maillets chirurgicaux  
Martillos quirúrgicos  
Martelli chirurgici

**Tampers**

Stößels  
Compacteurs  
Compactadores  
Compattatori

**Osteotomes**

Osteotome  
Ostéotomes  
Osteótomos  
Osteotomi

**Chisels**

Meißeln  
Burins  
Cinceles  
Scalpelli

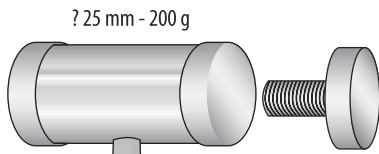

**WIS-FL-11R**

Paar Ersatzbacken  
 Pair of spare faces  
 Coppia di teste di ricambio  
 Pareja de tapas intercambiables  
 Paire de faces de rechange

MEAD  
**WIS-FL-11**  
 200 mm

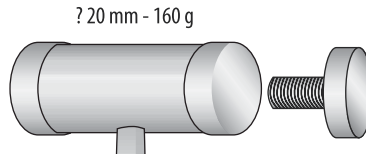

**WIS-FL-09R**

Paar Ersatzbacken  
 Pair of spare faces  
 Coppia di teste di ricambio  
 Pareja de tapas intercambiables  
 Paire de faces de rechange

MEAD  
**WIS-FL-09**  
 190 mm

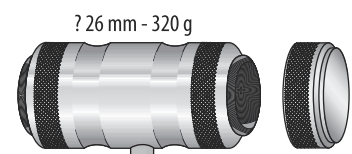

**WIS-FL-12R**

Paar Ersatzbacken  
 Pair of spare faces  
 Coppia di teste di ricambio  
 Pareja de tapas intercambiables  
 Paire de faces de rechange

MEAD  
**WIS-FL-12**  
 190 mm



? 20 mm - 140 g



**WIS-FL-01**  
 165 mm

? 25 mm - 300 g

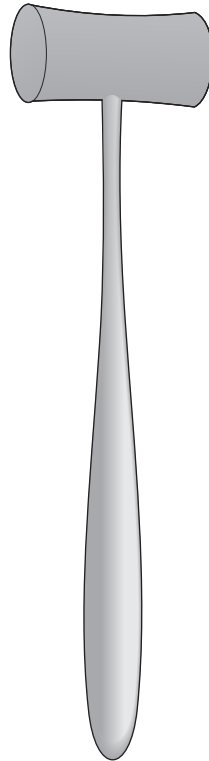

LUCAE  
**WIS-FL-10M**  
 190 mm

? 20 mm - 240 g

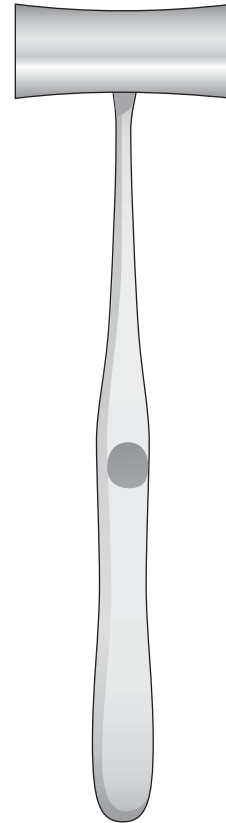

WILLIGER  
**WIS-FL-02**  
 240 mm



1 Seite ?ach - 1 Seite convex  
1 Side ?at - 1 Side convex  
1 Lato piatto - 1 Lato convesso  
1 Parte plana - 1 Parte convexa  
1 Face plate - 1 Face convexe

? 30 mm - 240 g

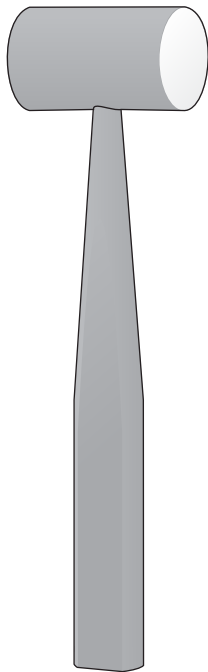

COTTLE  
**WIS-FL-104**  
185 mm

? 30 mm - 300 g

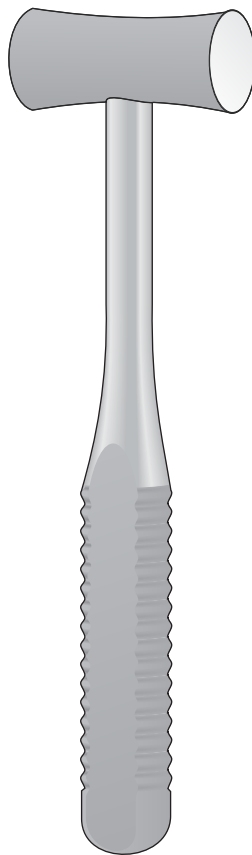

BERGMANN  
**WIS-FL-105**  
235 mm

? 45 mm - 300 g

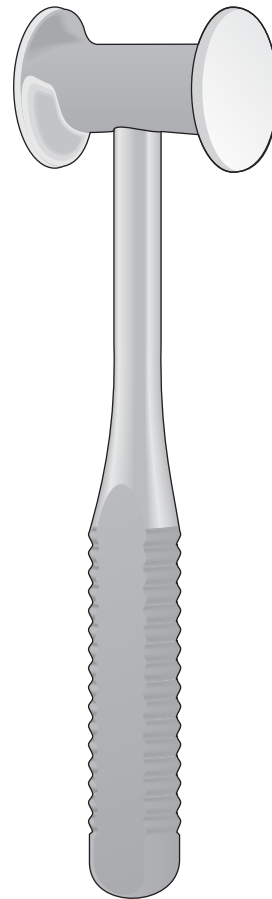

BERGMANN  
**WIS-FL-106**  
245 mm

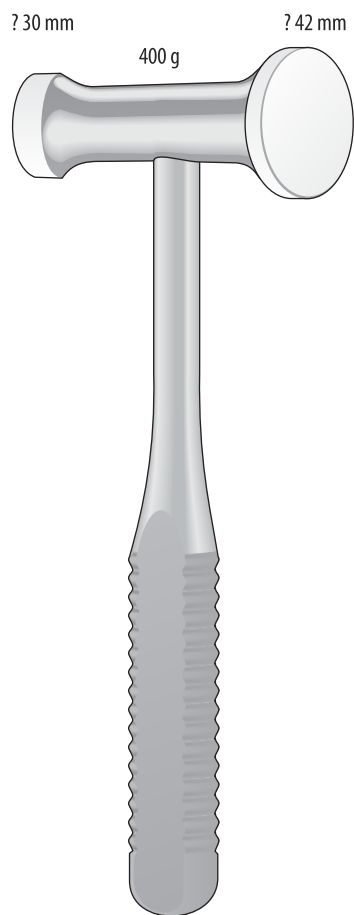

**WIS-FL-107**  
240 mm

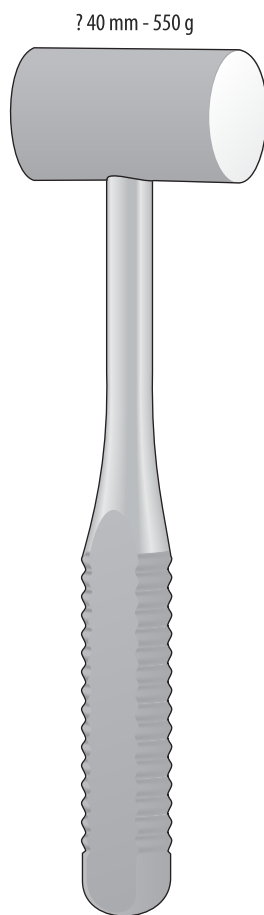

OMBREDANNE  
**WIS-FL-108**  
240 mm

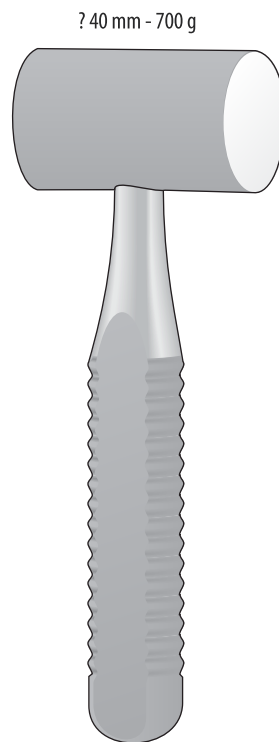

HEATH  
**WIS-FL-109**  
185 mm

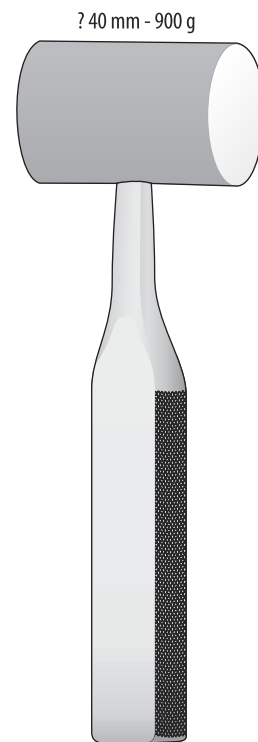

**WIS-FL-112**  
190 mm

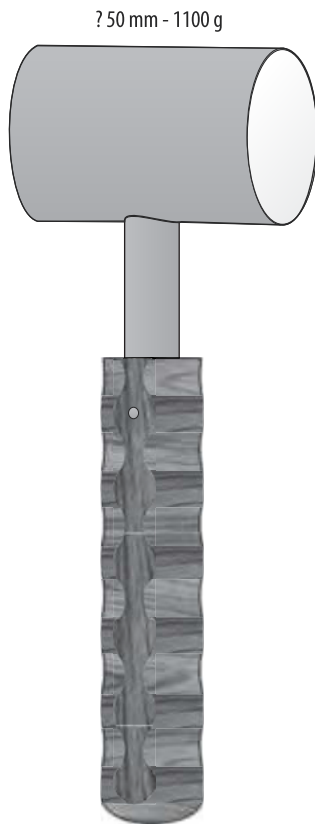

**WIS-FL-111**  
200 mm



**WIS-FL-06**  
260 mm

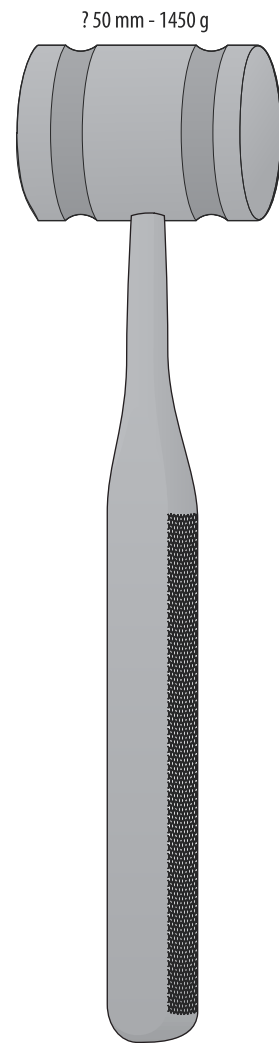

**WIS-FL-113**  
270 mm



-  **WIS-FF-147**  
3 mm
-  **WIS-FF-148**  
5 mm
-  **WIS-FF-149**  
8 mm

CASPAR  
**WIS-FF-147/WIS-FF-149**  
200 mm



-  **WIS-FL-253**  
12 mm
-  **WIS-FL-254**  
14 mm
-  **WIS-FL-255**  
16 mm

**WIS-FL-253/WIS-FL-255**  
200 mm



-  **FL-256**  
3x8 mm
-  **WIS-FL-257**  
4x10 mm
-  **WIS-FL-258**  
5x15 mm
-  **WIS-FL-259**  
6x20 mm

SYPERT  
**WIS-FL-256/WIS-FL-259**  
290 mm

Osteotome  
Stößels

Osteotomi  
Compattatori

Osteotomes  
Tampers

Ostéotomes  
Compacteurs

Osteótomos  
Compactadores

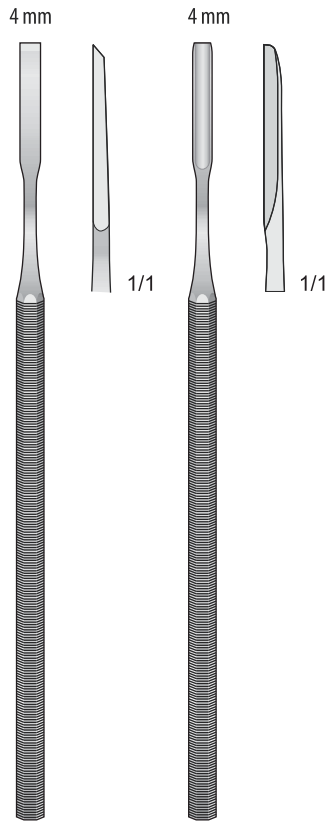

BUCKLEY  
WIS-TG-40  
160 mm

BUCKLEY  
WIS-TG-41  
160 mm

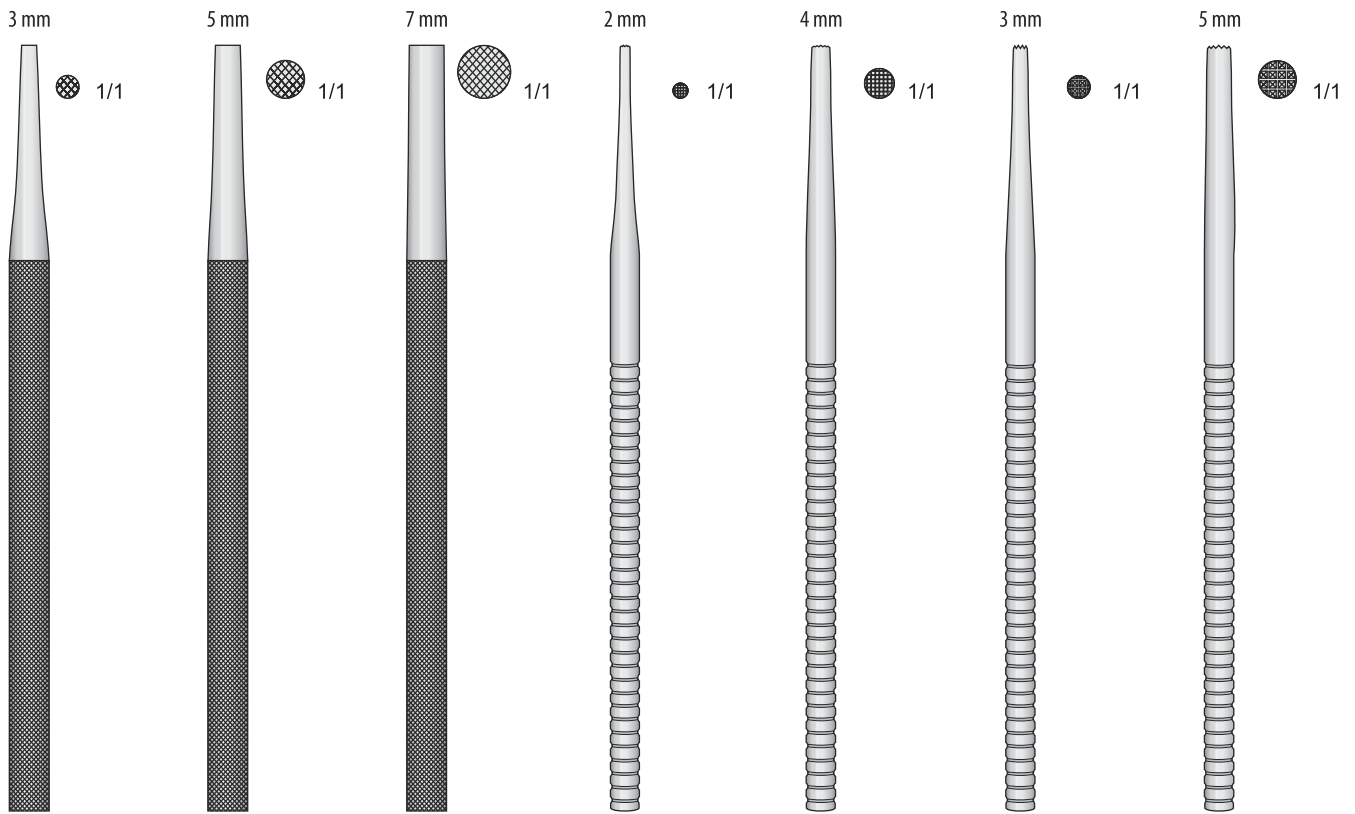

WIS-FL-20  
155 mm

WIS-FL-21  
155 mm

WIS-FL-22  
155 mm

WIS-FL-30  
155 mm

WIS-FL-31  
155 mm

WIS-FL-33  
155 mm

WIS-FL-35  
155 mm

**Osteotome  
Meißeln**

**Osteotomes  
Chisels**

**Osteotomi  
Scalpelli**

**Osteótomos  
Cinceles**

**Ostéotomes  
Burins**

Osteotome -Osteotomes  
Osteotomi - Oste?tomos - Ost?otomes

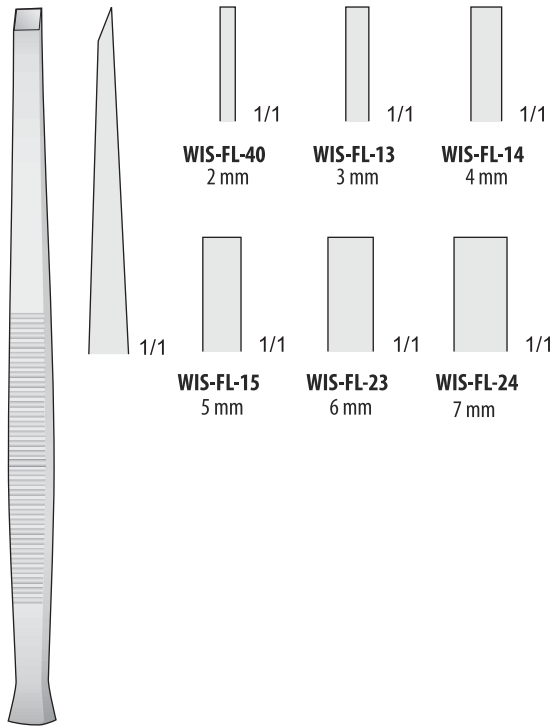

PARTSCH  
WIS-FL-13/WIS-FL-40  
140 mm

Hohlmeissel - Gouges  
Sgorbie - Gubias - Gouges

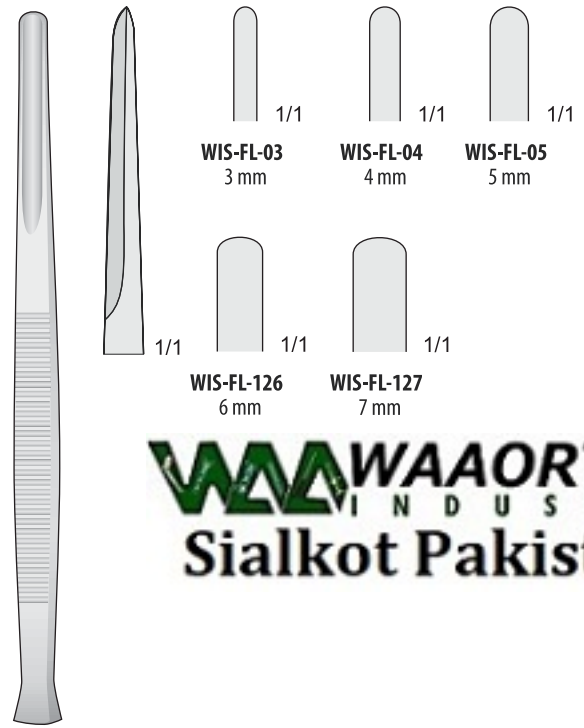

PARTSCH  
WIS-FL-03/WIS-FL-127  
140 mm



Osteotome -Osteotomes  
Osteotomi - Oste?tomos - Ost?otomes

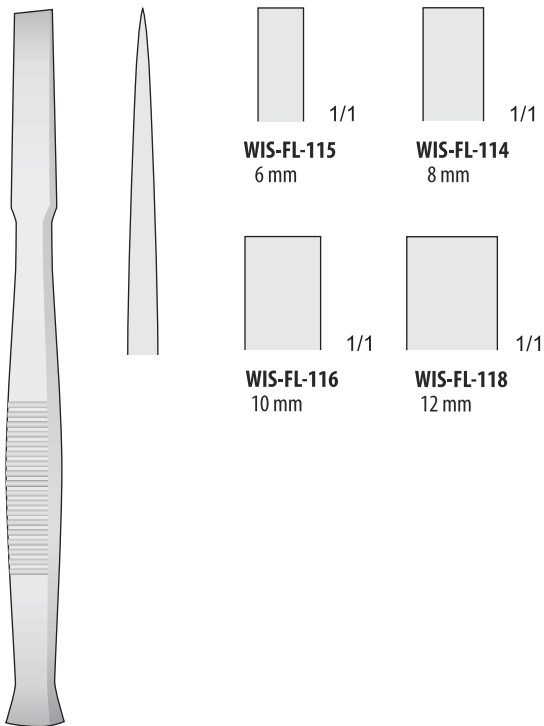

WIS-FL-114/WIS-FL-118  
140 mm

Hohlmeissel - Gouges  
Sgorbie - Gubias - Gouges

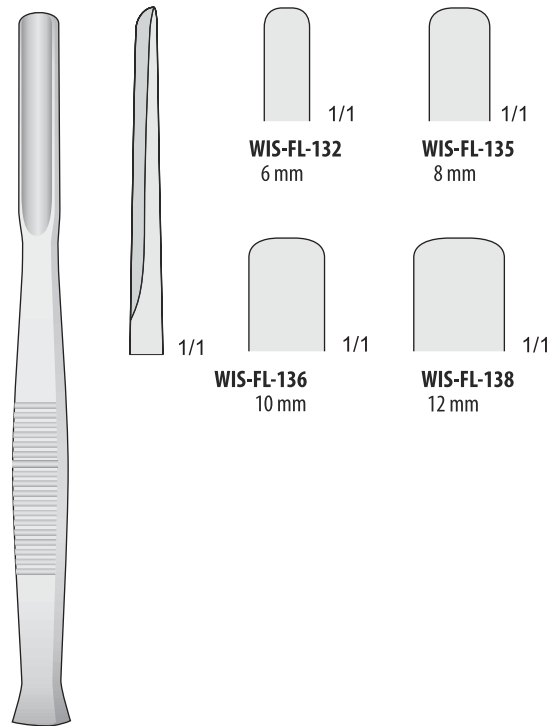

WIS-FL-132/WIS-FL-138  
140 mm

3 mm



**WIS-FL-177**

3 mm



**WIS-FL-185**

4 mm



**WIS-FL-179**

4 mm



**WIS-FL-156**

5 mm



**WIS-FL-181**

5 mm



**WIS-FL-187**

6 mm



**WIS-FL-183**

6 mm

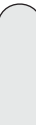

**WIS-FL-188**

7 mm

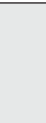

**WIS-FL-184**

7 mm

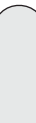

**WIS-FL-189**



**PARTSCH**  
**WIS-FL-177/WIS-FL-184**  
170 mm



1/1



**PARTSCH**  
**WIS-FL-185/WIS-FL-189**  
170 mm

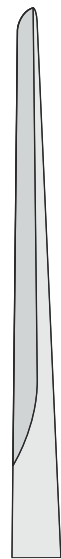

1/1

8 mm

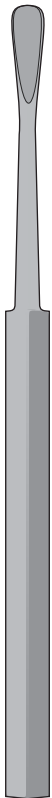

COSCIA  
WIS-FL-368  
180 mm

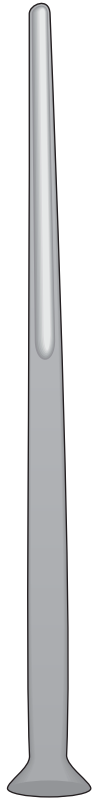

ALEXANDER  
WIS-FL-206/WIS-FL-209  
170 mm

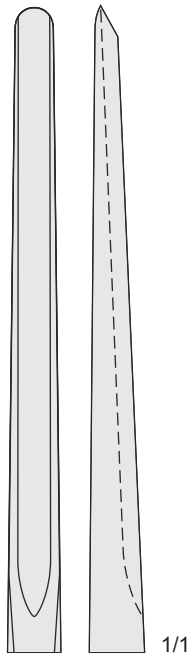

WIS-FL-206  
5 mm

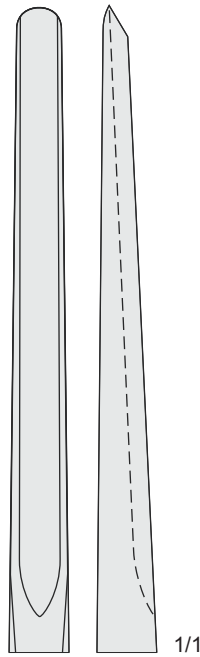

WIS-FL-207  
7 mm

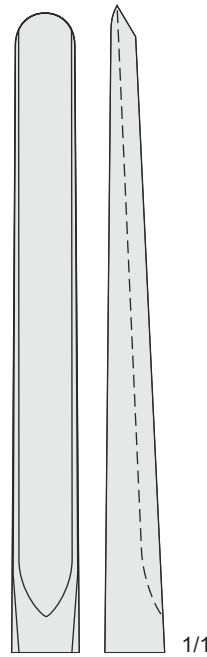

WIS-FL-208  
9 mm

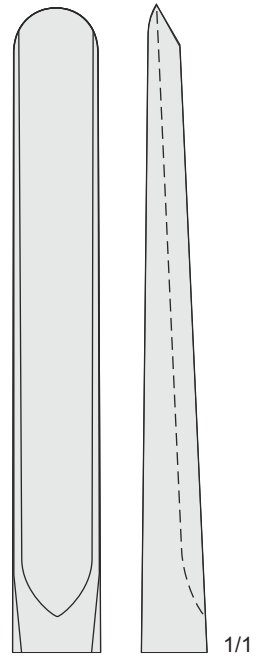

WIS-FL-209  
11 mm



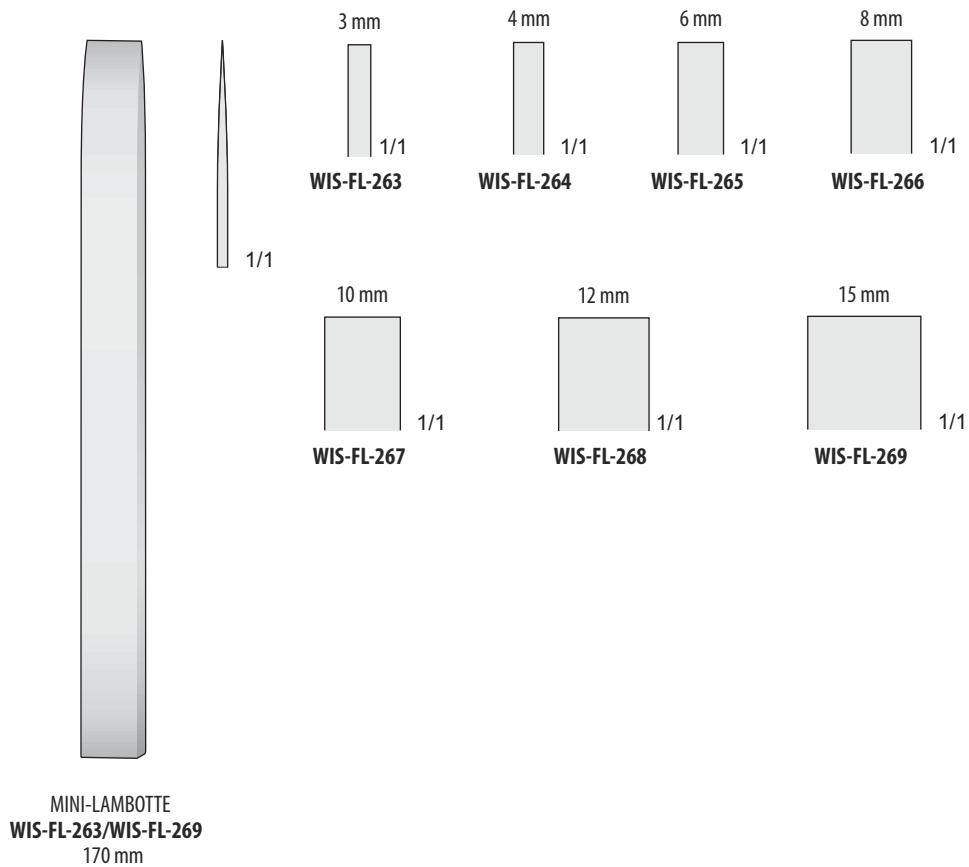
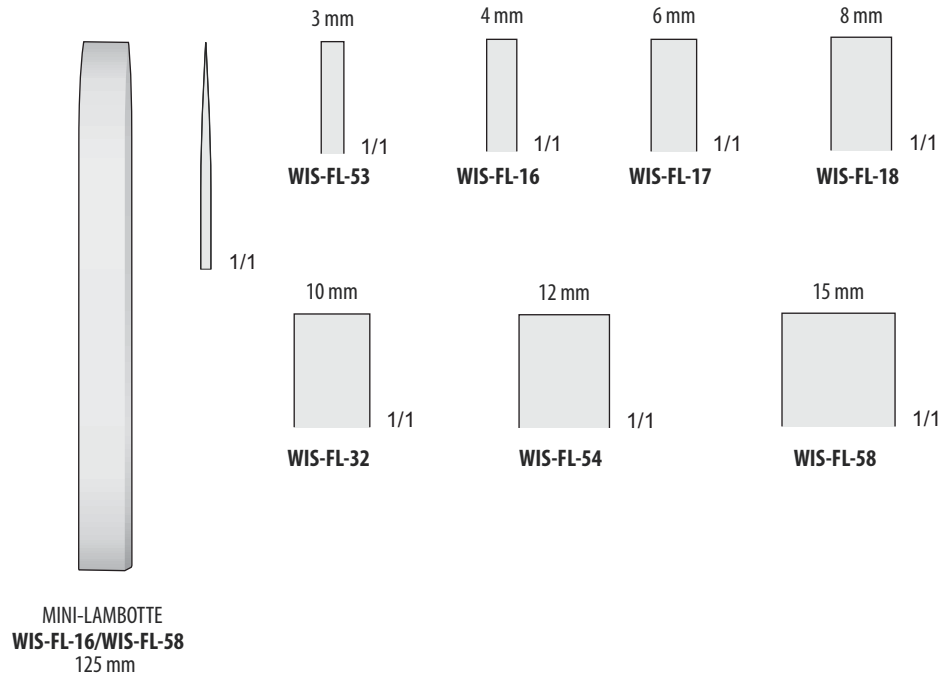

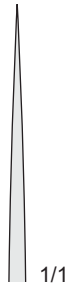

1/1

- WIS-FL-41** 4 mm
- WIS-FL-29** 8 mm
- WIS-FL-42** 10 mm
- WIS-FL-34** 13 mm
- WIS-FL-43** 15 mm
- WIS-FL-36** 18 mm
- WIS-FL-44** 20 mm
- WIS-FL-45** 25 mm
- WIS-FL-46** 30 mm
- WIS-FL-47** 38 mm
- WIS-FL-48** 44 mm
- WIS-FL-49** 50 mm

LAMBOTTE  
**WIS-FL-41/WIS-FL-49**  
250 mm



1/1

- WIS-FL-94** 8 mm
- WIS-FL-95** 13 mm
- WIS-FL-96** 18 mm
- WIS-FL-97** 25 mm
- WIS-FL-98** 30 mm
- WIS-FL-99** 38 mm

LAMBOTTE  
**WIS-FL-94/WIS-FL-99**  
250 mm

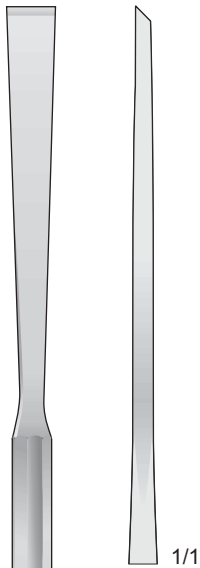

**WIS-FL-160** 6 mm  
**WIS-FL-162** 13 mm  
**WIS-FL-164** 19 mm

HIBBS  
**WIS-FL-160/WIS-FL-164**  
 230 mm

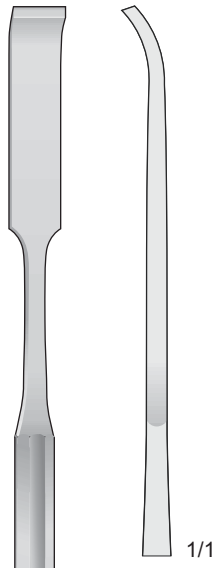

**WIS-FL-166** 6 mm  
**WIS-FL-168** 13 mm  
**WIS-FL-170** 19 mm

HIBBS  
**WIS-FL-166/WIS-FL-170**  
 230 mm

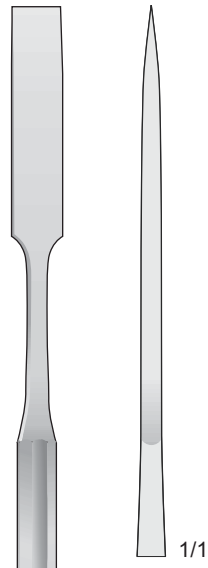

**WIS-FL-172** 6 mm  
**WIS-FL-174** 13 mm  
**WIS-FL-176** 19 mm

HIBBS  
**WIS-FL-172/WIS-FL-176**  
 230 mm

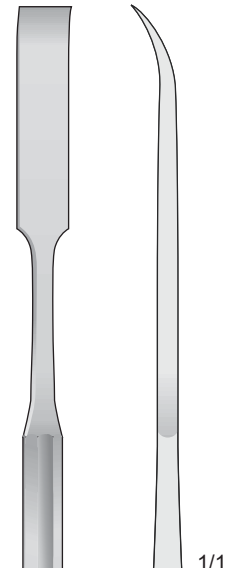

**WIS-FL-178** 6 mm  
**WIS-FL-180** 13 mm  
**WIS-FL-182** 19 mm

HIBBS  
**WIS-FL-178/WIS-FL-182**  
 230 mm

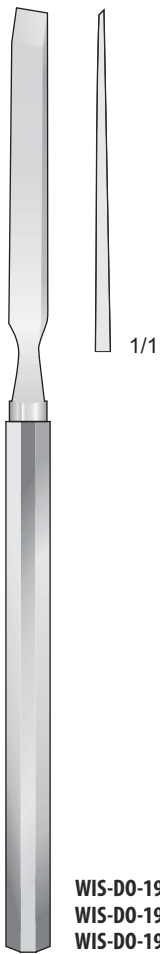

**WIS-DO-190/WIS-DO-192**  
180 mm

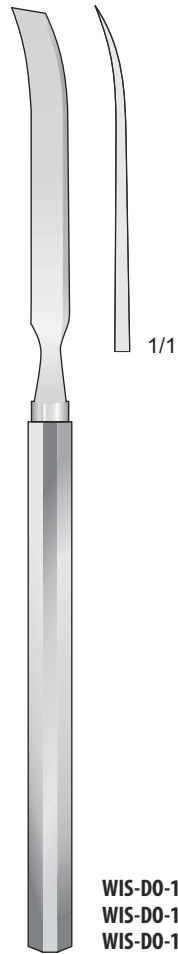

**WIS-DO-193/WIS-DO-195**  
180 mm

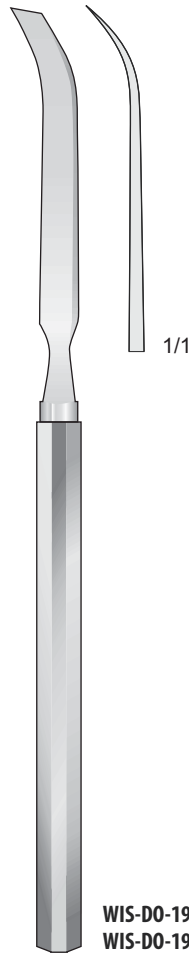

**WIS-DO-196/WIS-DO-197**  
180 mm

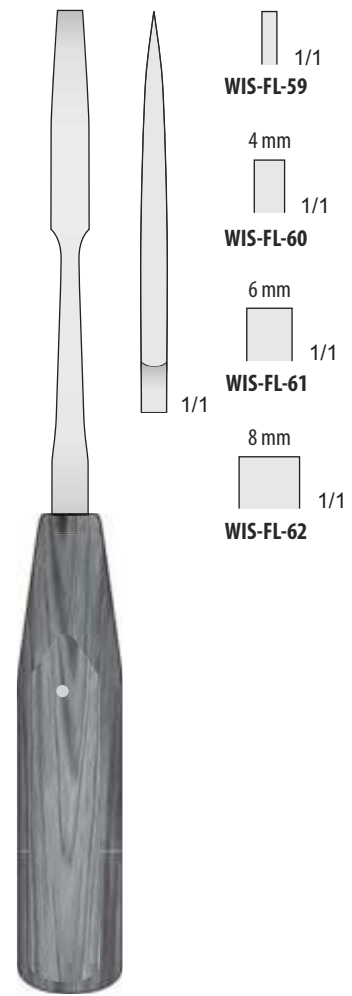

**MINI-LEXER**  
**WIS-FL-58/WIS-FL-62**  
200 mm

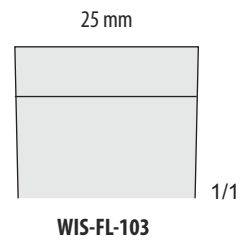
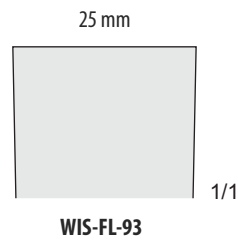
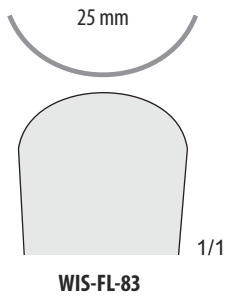
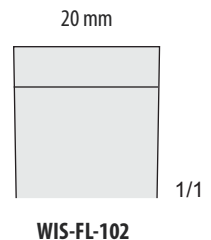
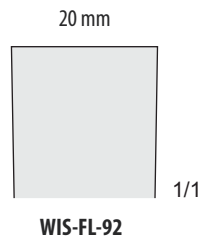
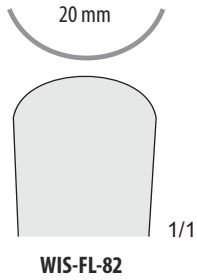
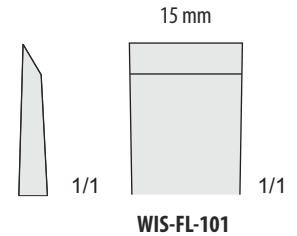
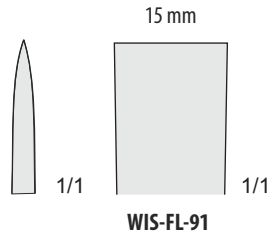
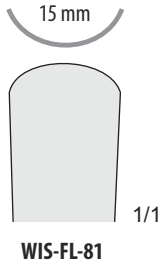
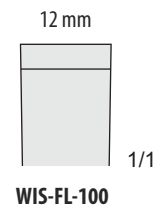
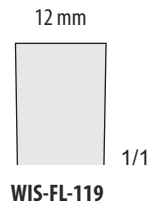
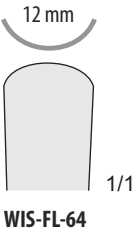
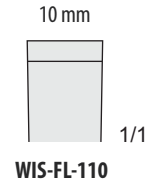
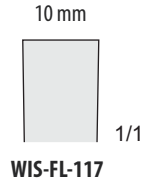
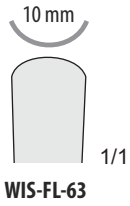

STILLE  
WIS-FL-63/WIS-FL-83  
200 mm

STILLE  
WIS-FL-91/WIS-FL-119  
200 mm

STILLE  
WIS-FL-100/WIS-FL-110  
200 mm

6 mm



**WIS-FL-340**

6 mm



**WIS-FL-347**

9 mm



**WIS-FL-341**

13 mm

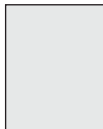

**WIS-FL-342**

9 mm



**WIS-FL-348**

13 mm



**WIS-FL-349**

16 mm



**WIS-FL-343**

19 mm



**WIS-FL-344**

25 mm



**WIS-FL-345**

32 mm



**WIS-FL-346**

SMITH-PETERSEN  
**WIS-FL-340/WIS-FL-346**  
200 mm

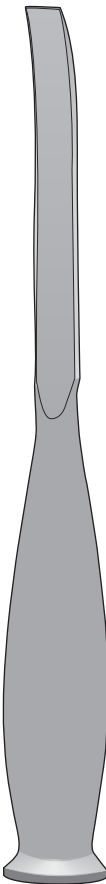

SMITH-PETERSEN  
**WIS-FL-347/WIS-FL-353**  
200 mm

1/1

16 mm



**WIS-FL-350**

19 mm



**WIS-FL-351**

25 mm



**WIS-FL-352**

32 mm



**WIS-FL-353**

SMITH-PETERSEN  
**WIS-FL-354/WIS-FL-357**  
200 mm

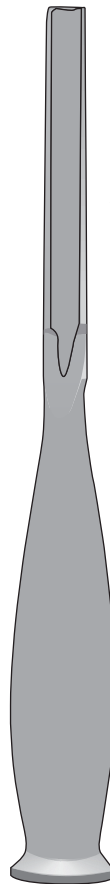

9 mm



**WIS-FL-354**

13 mm



**WIS-FL-355**

19 mm



**WIS-FL-356**

25 mm



**WIS-FL-357**

SMITH-PETERSEN  
**WIS-FL-354/WIS-FL-357**  
200 mm

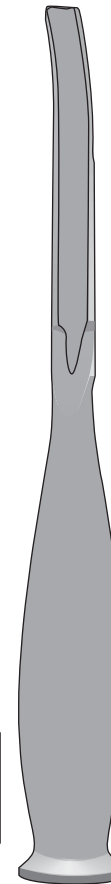

9 mm



**WIS-FL-359**

13 mm



**WIS-FL-360**

19 mm



**WIS-FL-361**

25 mm



**WIS-FL-362**

SMITH-PETERSEN  
**WIS-FL-359/WIS-FL-362**  
200 mm

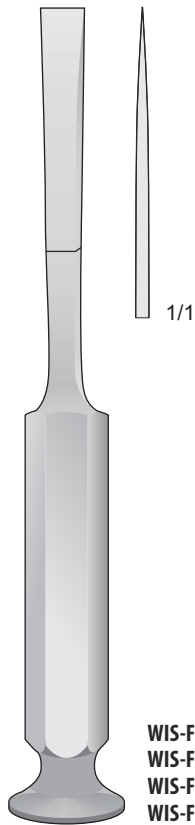

TESSIER  
**WIS-FL-307/WIS-FL-310**  
200 mm

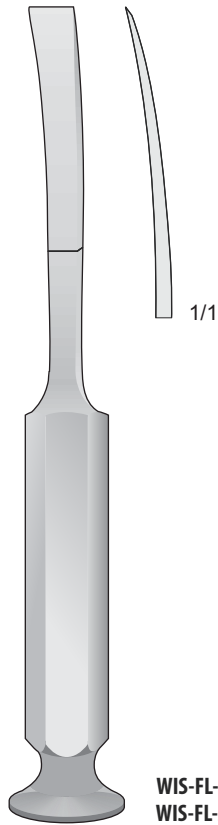

TESSIER  
**WIS-FL-311/WIS-FL-312**  
200 mm

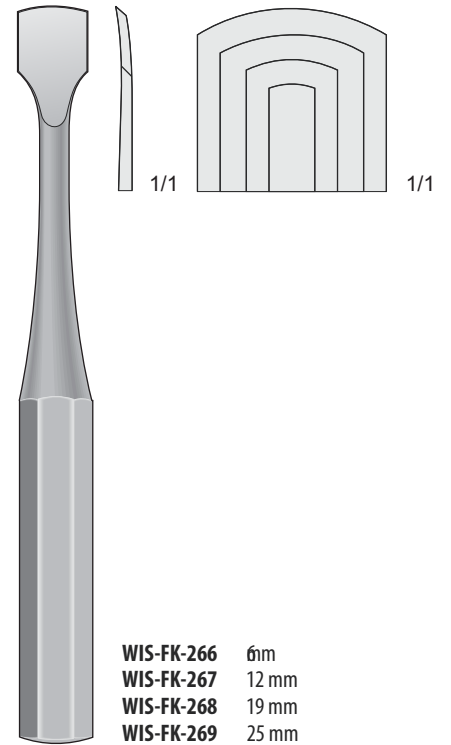

KEY  
**WIS-FL-266/WIS-FL-269**  
190 mm

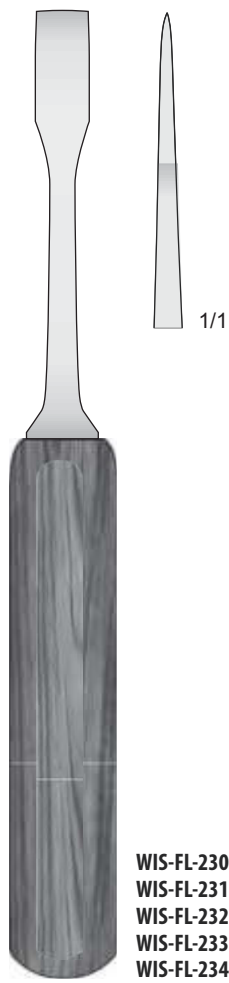

MINI-LEXER  
WIS-FL-230/WIS-FL-234  
180 mm

- WIS-FL-230 4 mm
- WIS-FL-231 6 mm
- WIS-FL-232 8 mm
- WIS-FL-233 10 mm
- WIS-FL-234 12 mm



MINI-LEXER  
WIS-FL-240/WIS-FL-244  
180 mm

- WIS-FL-240 4 mm
- WIS-FL-241 6 mm
- WIS-FL-242 8 mm
- WIS-FL-243 10 mm
- WIS-FL-244 12 mm



LEXER  
WIS-FL-190/WIS-FL-194  
180 mm

- WIS-FL-190 4 mm
- WIS-FL-191 6 mm
- WIS-FL-192 8 mm
- WIS-FL-193 10 mm
- WIS-FL-194 12 mm



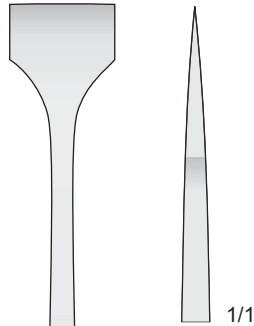

LEXER  
WIS-FL-210/WIS-FL-216  
220 mm

- WIS-FL-210 5 mm
- WIS-FL-211 7 mm
- WIS-FL-212 10 mm
- WIS-FL-213 15 mm
- WIS-FL-214 20 mm
- WIS-FL-215 25 mm
- WIS-FL-216 30 mm

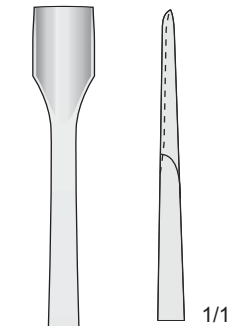

LEXER  
WIS-FL-220/WIS-FL-226  
220 mm

- WIS-FL-220 5 mm
- WIS-FL-221 7 mm
- WIS-FL-222 10 mm
- WIS-FL-223 15 mm
- WIS-FL-224 20 mm
- WIS-FL-225 25 mm
- WIS-FL-226 30 mm

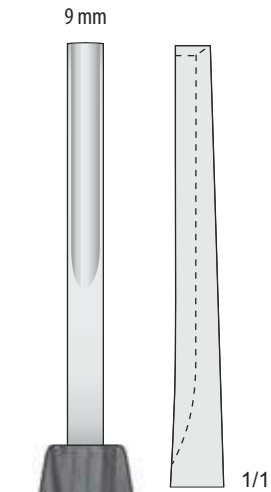

WIS-FL-272  
220 mm



**WIS-FL-280/WIS-FL-281**  
200 mm

**WIS-FL-282/WIS-FL-283**  
200 mm

**WIS-FL-284/WIS-FL-285**  
200 mm

Hohlmeissel - Gouges  
Sgorbie - Gubias - Gouges



**WAA** WAAORTHO  
INDUSTRY  
Sialkot Pakistan

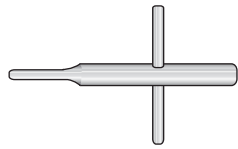

**WIS-FL-84**  
90 mm

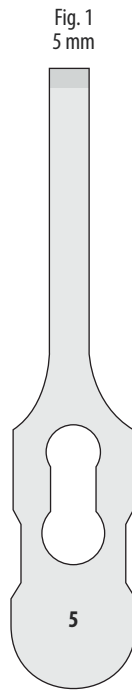

**WIS-FL-86**  
85 mm



**WIS-FL-87**  
85 mm



**WIS-FL-88**  
85 mm

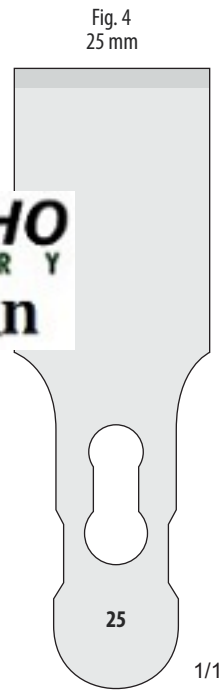

**WIS-FL-89**  
85 mm



Mei?el  
Chisel  
Scalpelli  
Cinceles  
Ciseaux-burins



**WIS-FL-85**  
190 mm

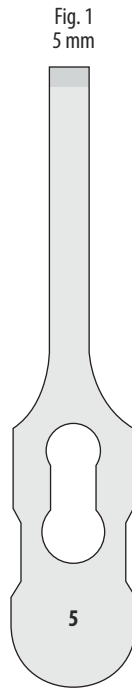

**WIS-FL-286**  
85 mm

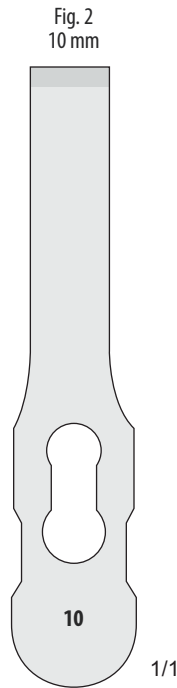

**WIS-FL-287**  
85 mm

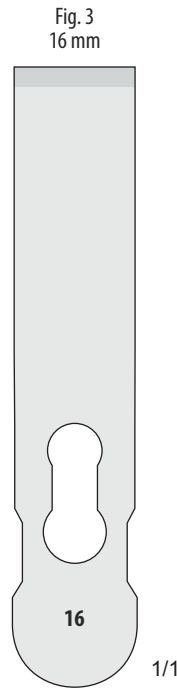

**WIS-FL-288**  
85 mm

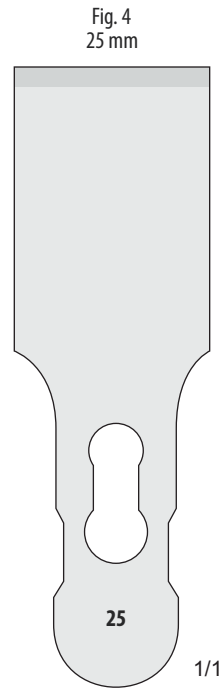

**WIS-FL-289**  
85 mm



Osteotom  
Gouge  
Osteotomi  
Cubias  
Gouges

**Bone surgery**

Knochenchirurgie  
Chirurgie osseuse  
Cirugía ósea  
Chirurgia ossea

**Bone Holding Forceps**

Knochenhaltezange  
Daviers à os  
Pinzas de sujeción para hueso  
Pinze per ?ssare l?osso

**Hand Surgery**

Handchirurgie  
Chirurgie de la main  
Cirugía de la mano  
Chirurgia della mano

**Bone Rongeurs**

Hohlmeißelzangen  
Pincés gouges  
Pinzas gubias  
Pinze ossivore

**Bone Cutting Scissors**

Knochensplitterscheren  
Ciseaux à os  
Tijeras para huesos  
Forbici ossivore

Repositionszangen - Reposition forceps  
Pinze riposizionatrici di osso - Pinzas para la reducci?n de huesos

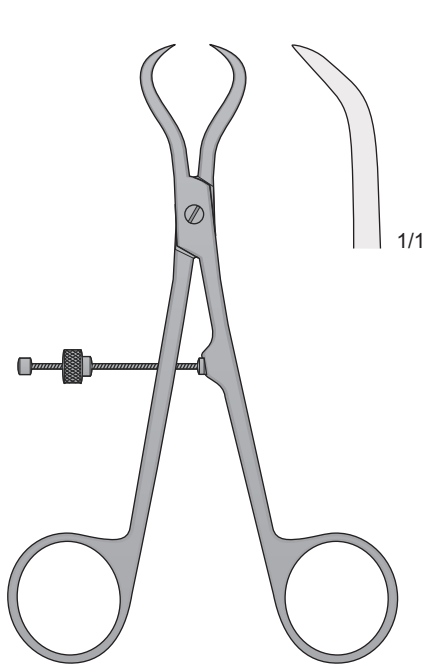

**WIS-F0-79**  
140 mm

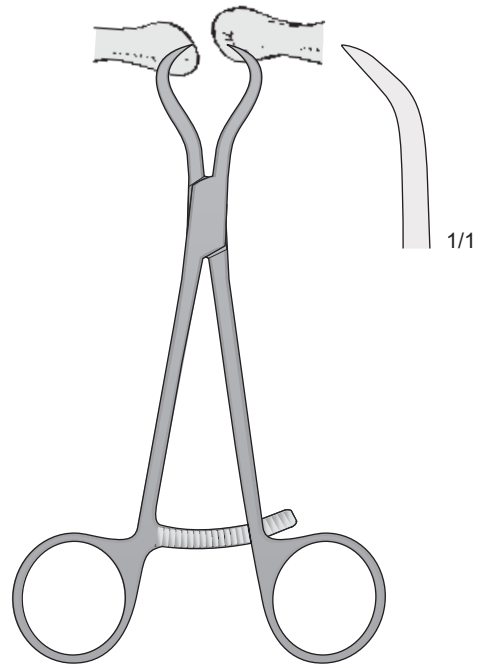

**WIS-F0-66**  
135 mm

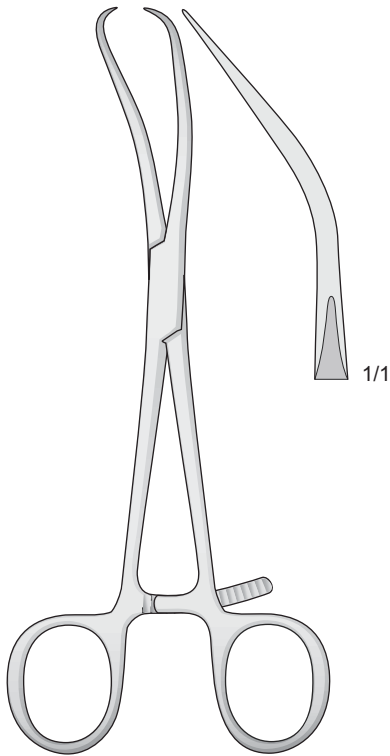

REILL  
**WIS-F0-64**  
170 mm

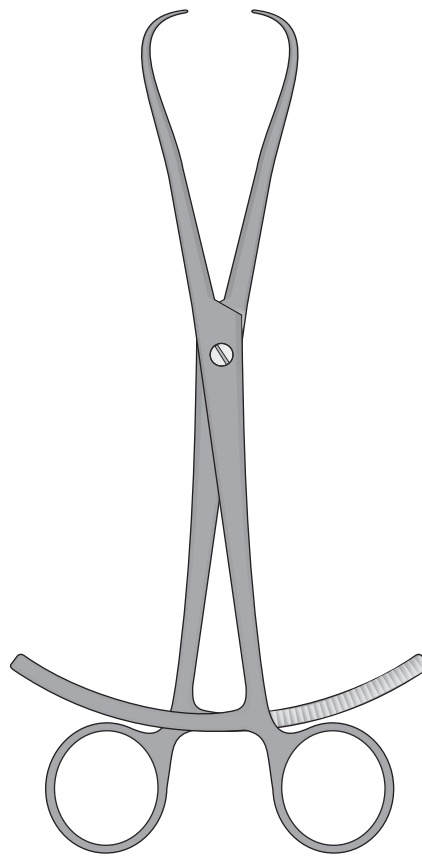

**WIS-F0-68**  
200 mm

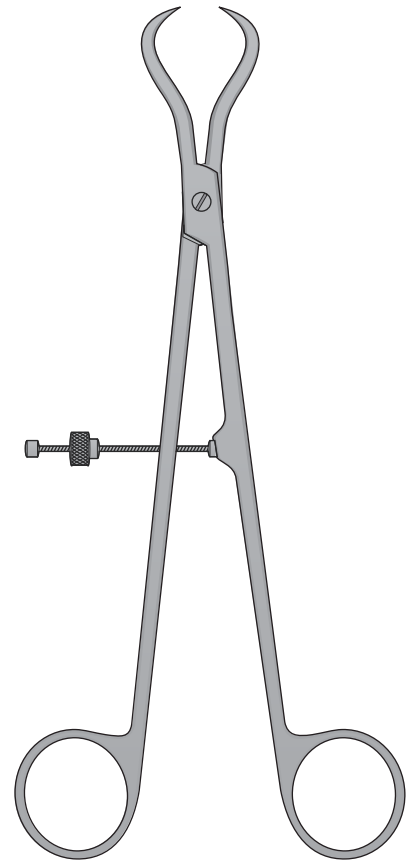

**WIS-F0-81**  
210 mm

Meniskus und Knorpelfasszangen - Meniscus and cartilage clamp  
Pinze per menisco e cartilagine - Pincers for meniscus and cartilages

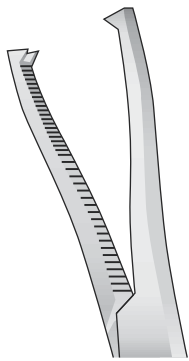

DINGMANN  
WIS-F0-130

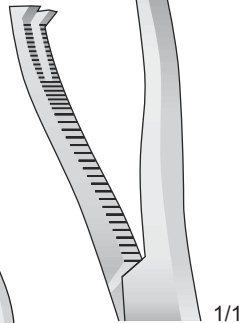

DINGMANN MODIF.  
WIS-F0-131

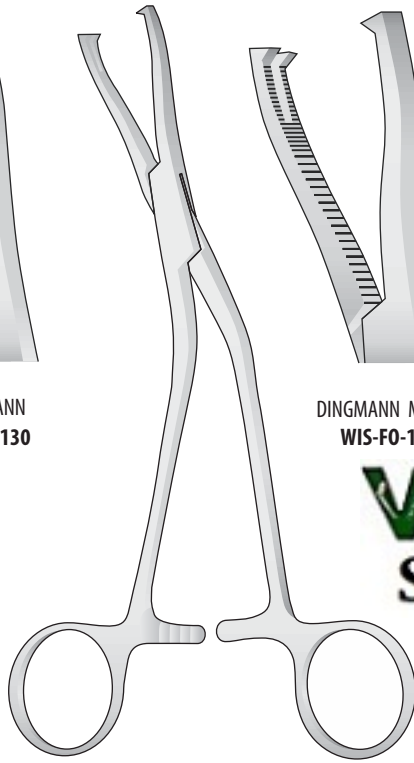

DINGMANN  
WIS-F0-130/WIS-F0-131  
190 mm

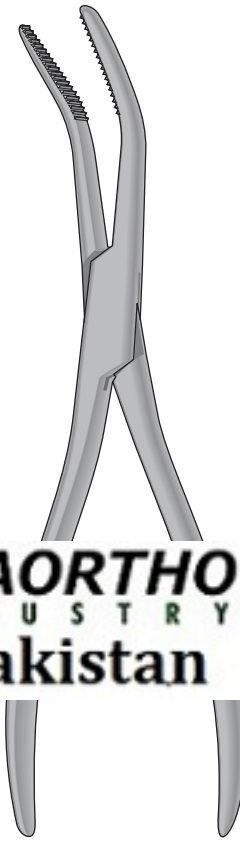

VAN BUREN  
WIS-F0-217  
225 mm

Seitwärts gebogen  
Curved to side  
Curva su un lato

**WAAORTH**  
INDUSTRY  
Sialkot Pakistan

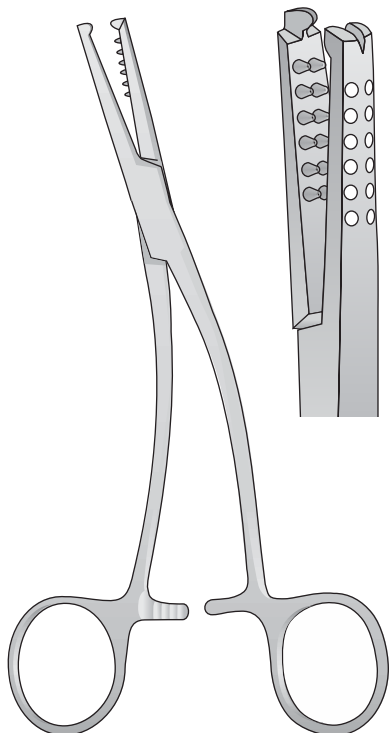

WIS-F0-134  
185 mm

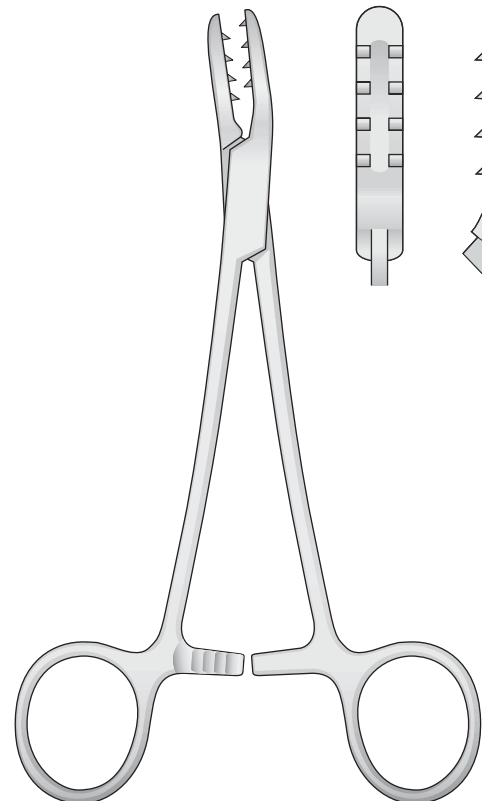
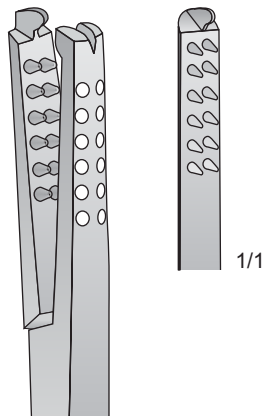

MARTIN  
WIS-F0-133  
200 mm

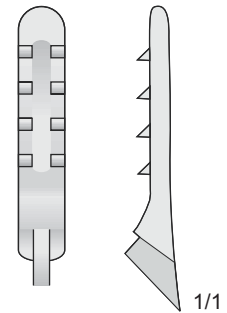

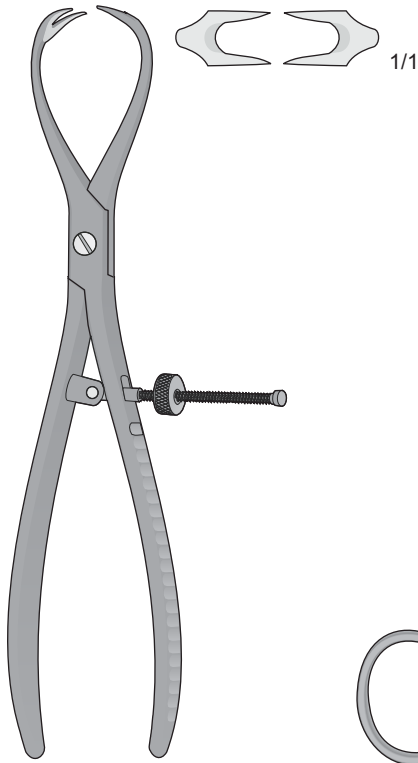

PATELLA  
**WIS-FO-46**  
185 mm

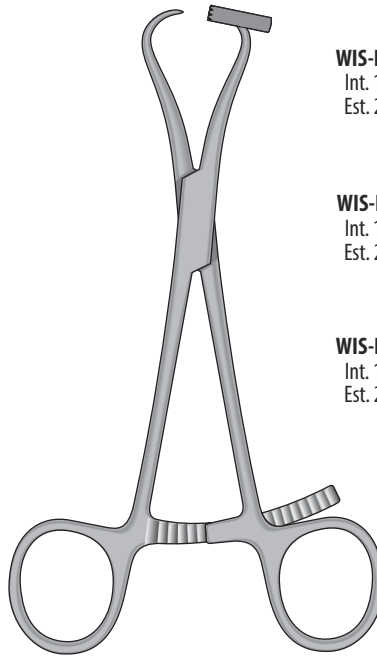

**WIS-FO-240/WIS-FO-242**  
140 mm

○  
**WIS-FO-240**  
Int. 1,0 mm  
Est. 2,0 mm

○  
**WIS-FO-241**  
Int. 1,3 mm  
Est. 2,3 mm

○  
**WIS-FO-242**  
Int. 1,6 mm  
Est. 2,6 mm

Zange mit Gewindsperre  
Forceps with thread fixation  
Pinza con regolazione  
Davier avec syst?me d'arr?t ?let?

Zange mit Zahnsperre  
Forceps with ratchet fixation  
Pinza con cremagliera  
Davier ?cr?mail?re

Zange mit Gewindsperre  
Forceps with thread fixation  
Pinza con regolazione  
Davier avec syst?me d'arr?t ?let?

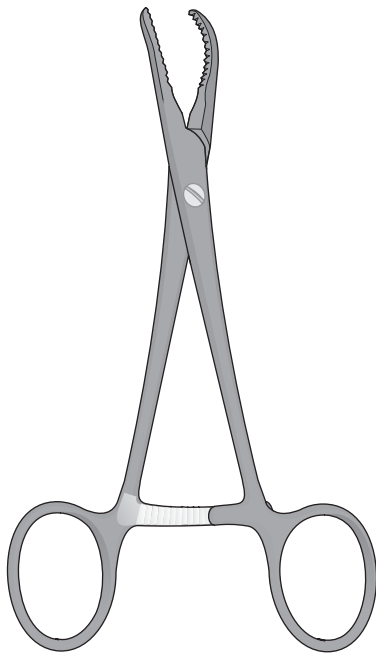

**WIS-FO-47**  
140 mm

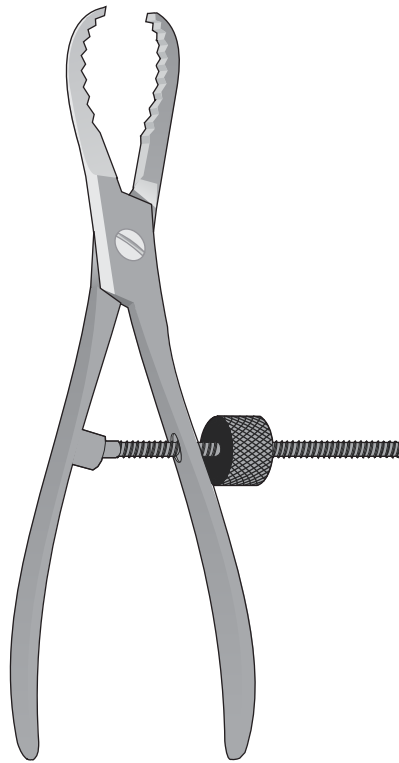

**WIS-FO-48**  
170 mm

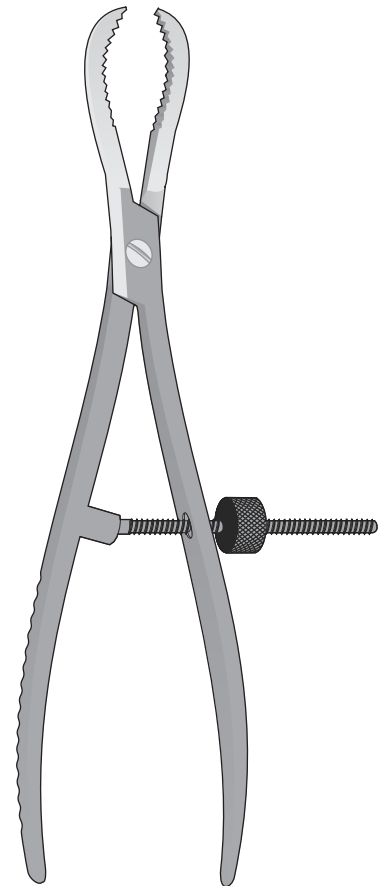

**WIS-FO-49**  
235 mm



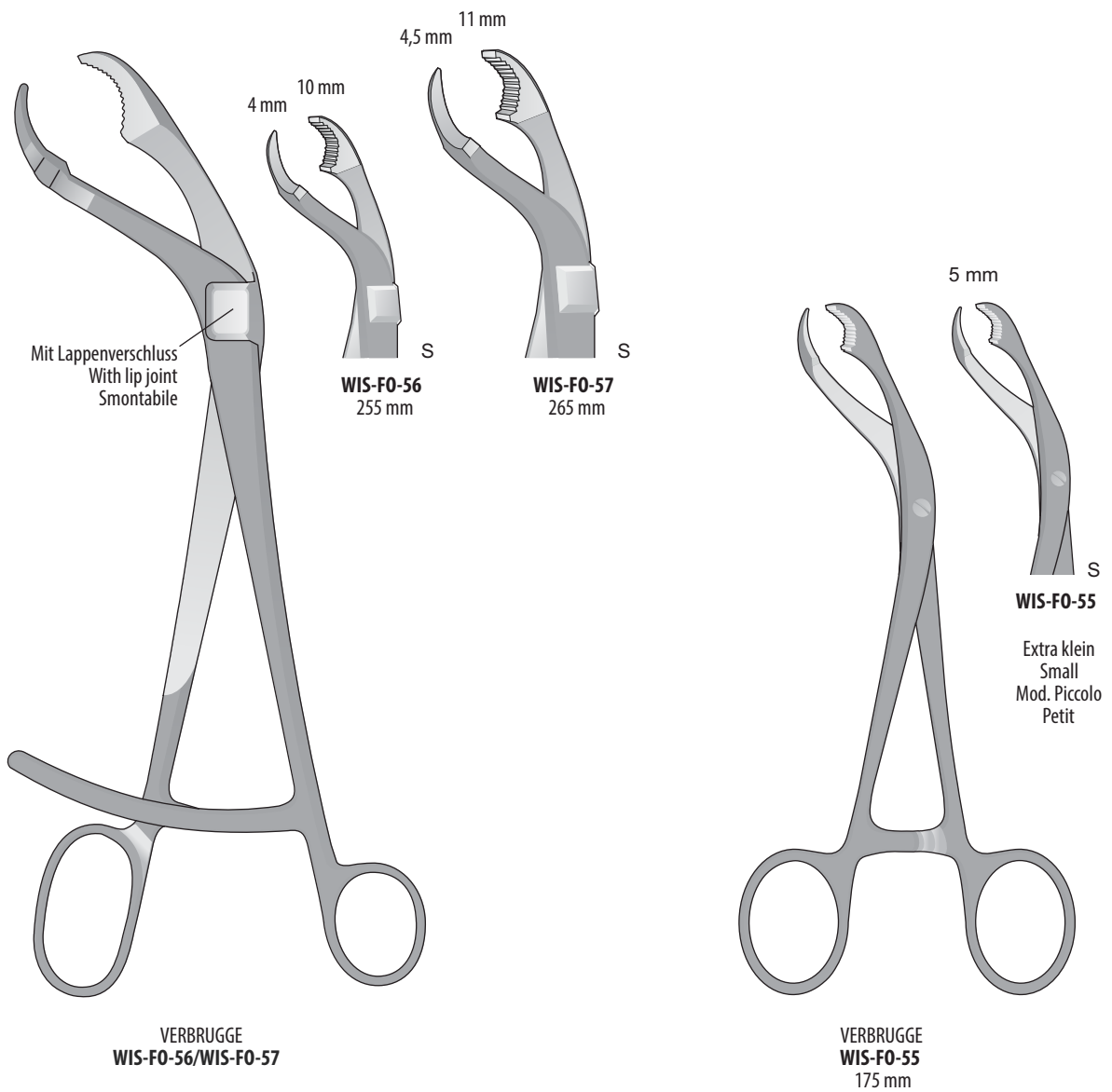

Selbstzentrierend mit Gewindesperre  
Self-centering bone holding forceps with thread lock  
Autocentrante con blocco  
? centrage automatique avec arr?t de ?letage

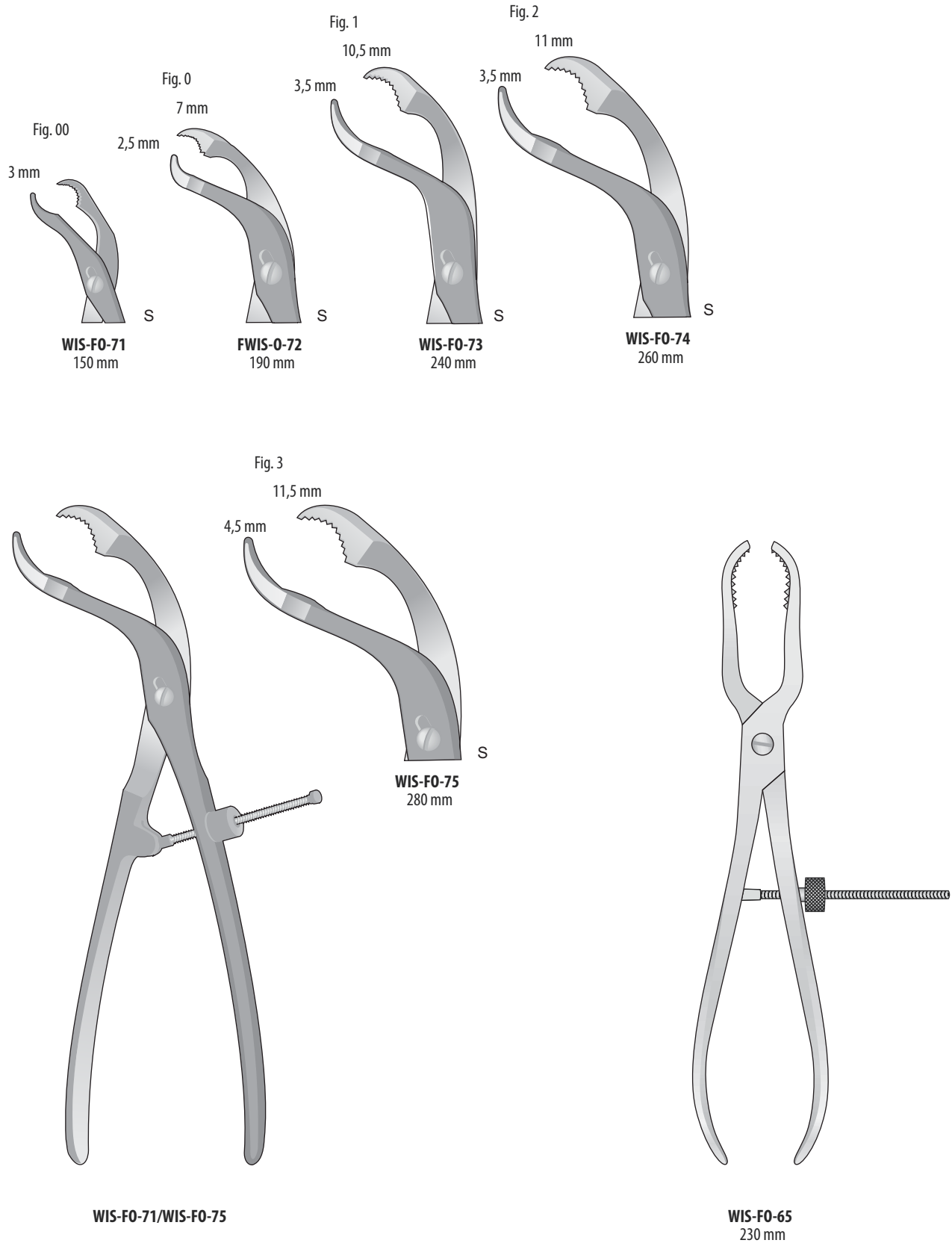

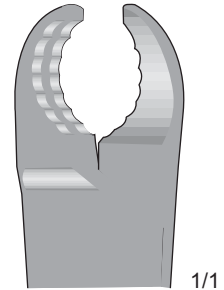

**WIS-F0-62**  
230 mm

1/1

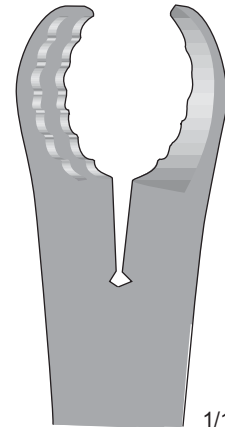

**WIS-F0-82**  
250 mm

1/1

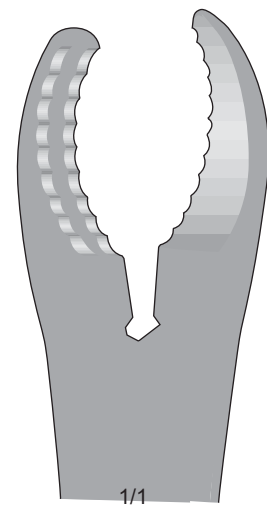

**WIS-F0-105**  
280 mm

1/1

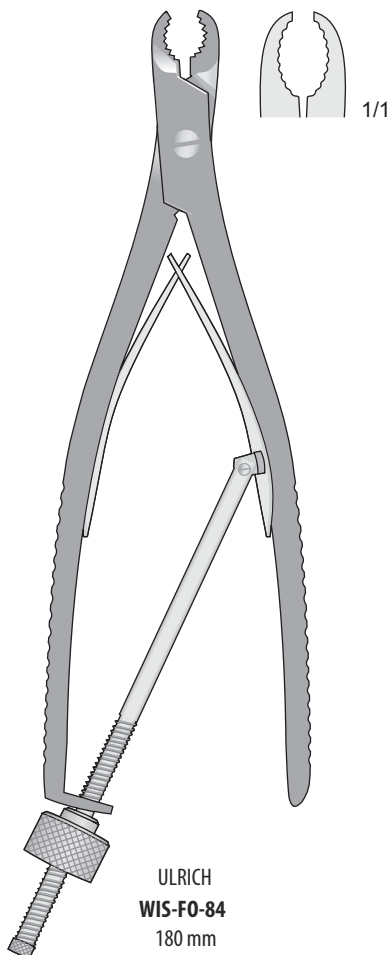

**ULRICH**  
**WIS-F0-84**  
180 mm

1/1

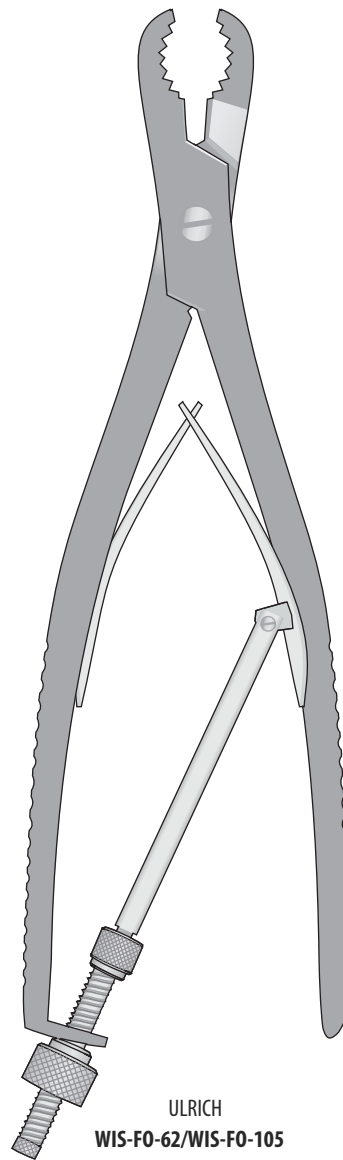

**ULRICH**  
**WIS-F0-62/WIS-F0-105**  
260 mm



FARABEUF-LAMBOTTE  
**WIS-F0-52**  
250 mm

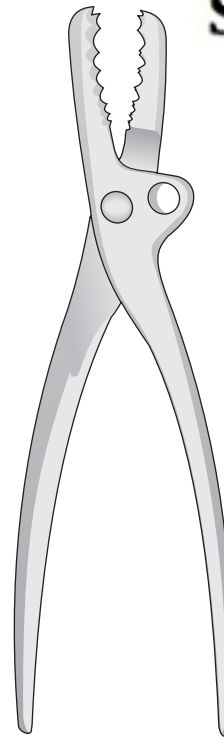

FARABEUF  
**WIS-F0-51/WIS-F0-54**

9 mm  
1/1  
**WIS-F0-54**  
230 mm

11 mm  
1/1  
**WIS-F0-51**  
250 mm

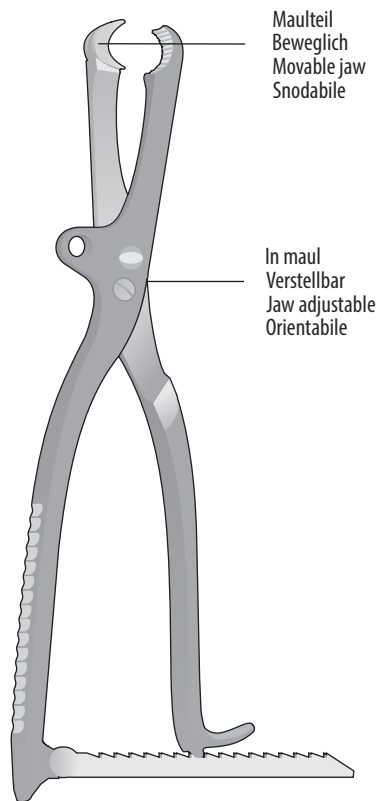

LAMBOTTE  
**WIS-F0-44**  
265 mm

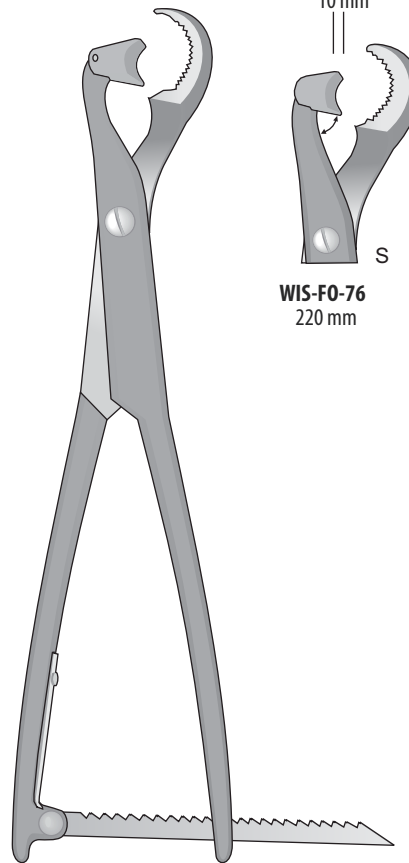

LAMBOTTE  
**WIS-F0-50/WIS-F0-76**

10 mm  
**WIS-F0-76**  
220 mm

13 mm  
**WIS-F0-53**  
260 mm

16 mm  
**WIS-F0-50**  
330 mm

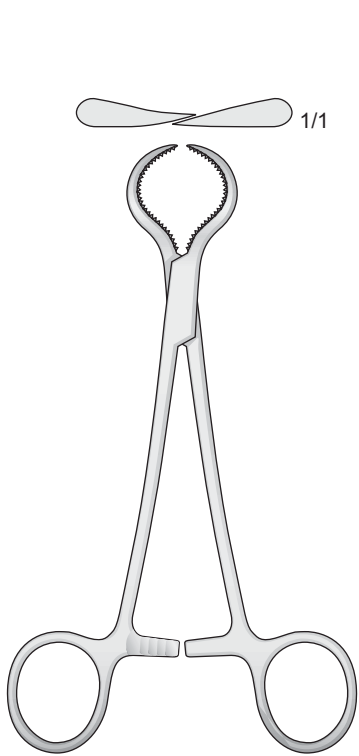

LEWIN  
WIS-FO-69  
180 mm

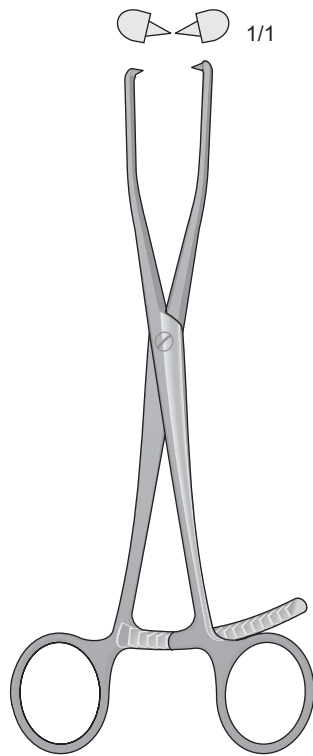

WIS-FO-67  
210 mm

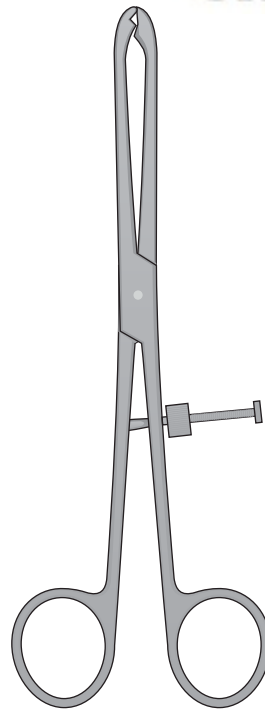

FIBULA  
WIS-FO-93/WIS-FO-94  
210 mm

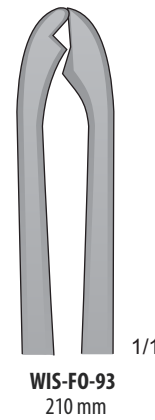

WIS-FO-93  
210 mm

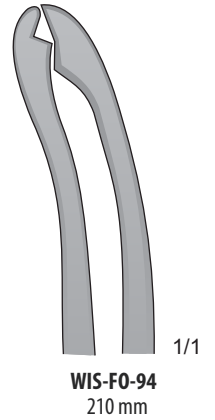

WIS-FO-94  
210 mm

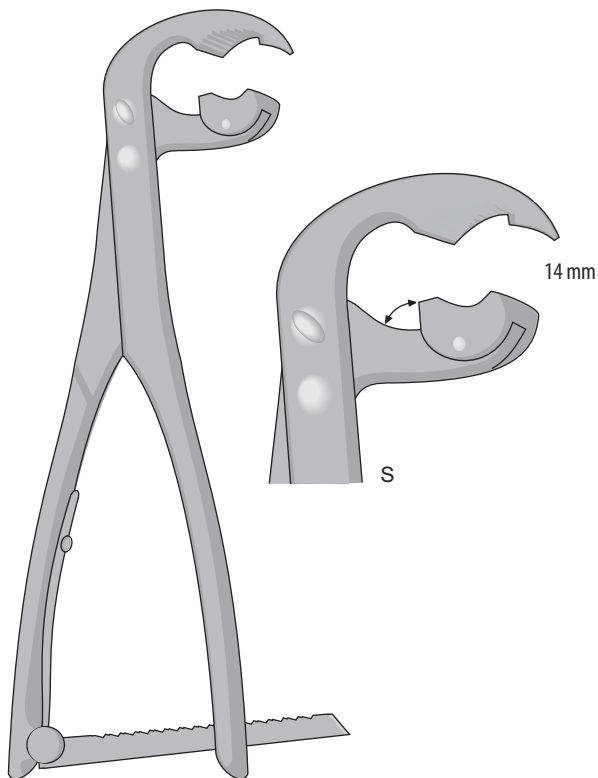

WIS-FO-78  
215 mm

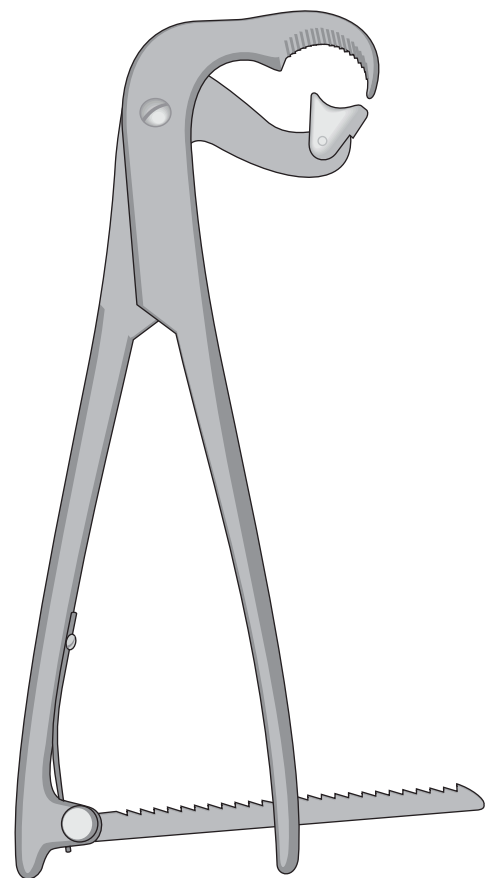

WIS-FO-106  
275 mm

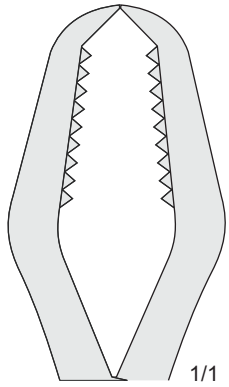

1/1

13 mm

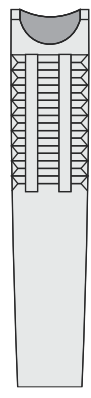
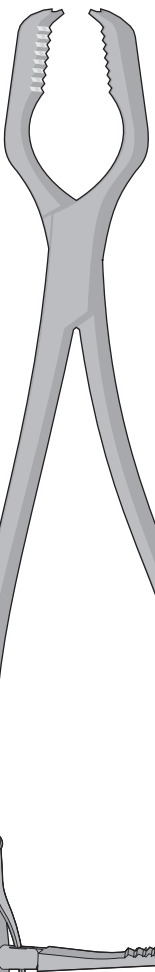

1/1

LANE  
WIS-FO-116  
320 mm

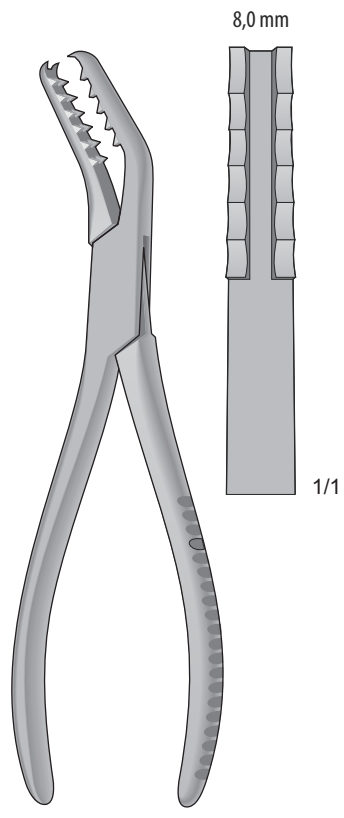

8,0 mm

1/1

SEMB  
WIS-FO-236  
190 mm

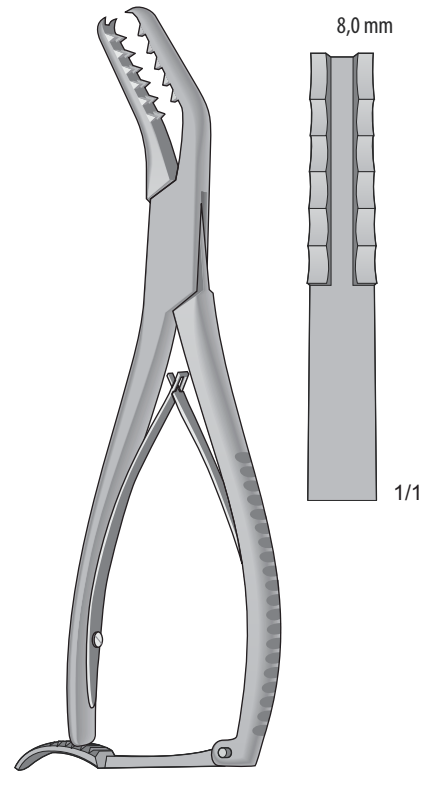

8,0 mm

1/1

SEMB  
WIS-FO-237  
190 mm

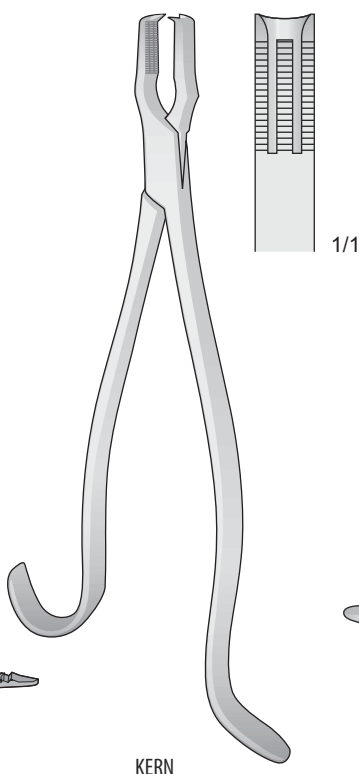

1/1

KERN  
WIS-FO-114 170 mm  
WIS-FO-115 220 mm

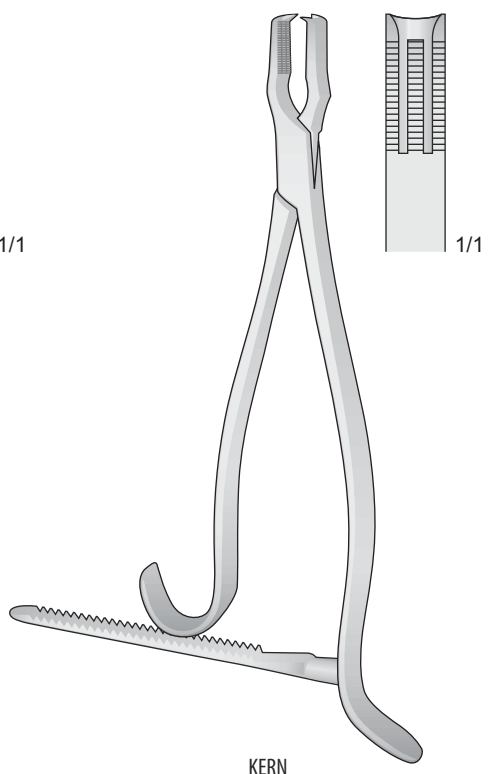

1/1

KERN  
WIS-FO-110 170 mm  
WIS-FO-112 220 mm

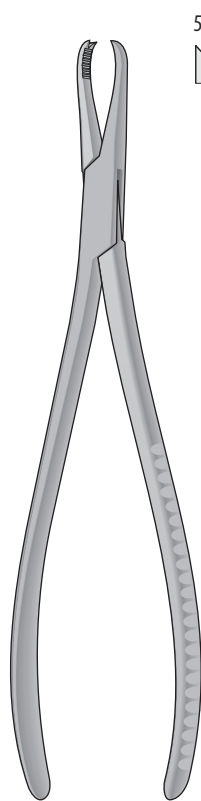

5 mm  
 1/1

LANGENBECK  
**WIS-F0-99**  
 200 mm



11 mm  
 1/1

LANGENBECK  
**WIS-F0-111**  
 205 mm

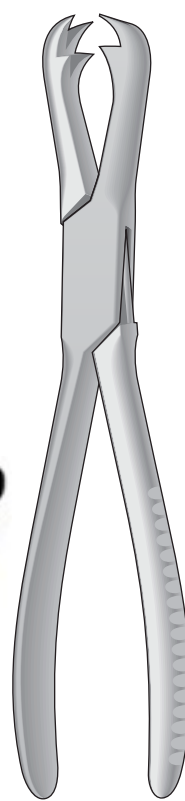

12 mm  
 1/1

FERGUSSON  
**WIS-F0-113**  
 205 mm

**WAA**WAA**ORTHO**  
 I N D U S T R Y  
**Sialkot Pakistan**

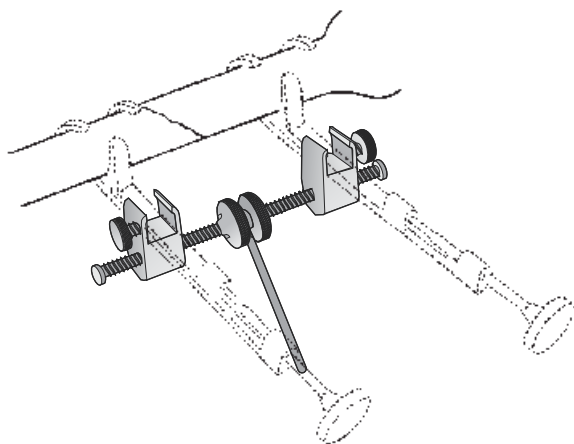

GERSTER  
**WIS-F0-96**

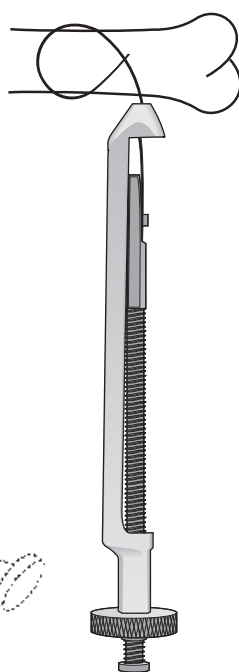

PARHAM  
**WIS-F0-98**  
 175 mm

Matrice di ricambio  
 per WIS-F0-98



**WIS-F0-97**  
 190 mm

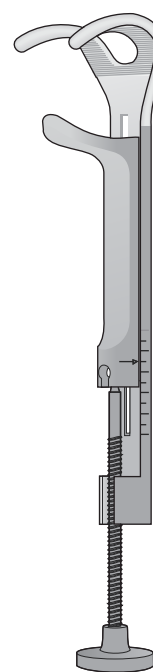

GERSTER-LOWMAN  
**WIS-F0-90** 120 mm  
**WIS-F0-91** 185 mm  
**WIS-F0-92** 200 mm

# WAAORTH INDUSTRY Sialkot Pakistan

F?r kinder  
For children  
Per bambini  
Para ni?os  
Pour enfants

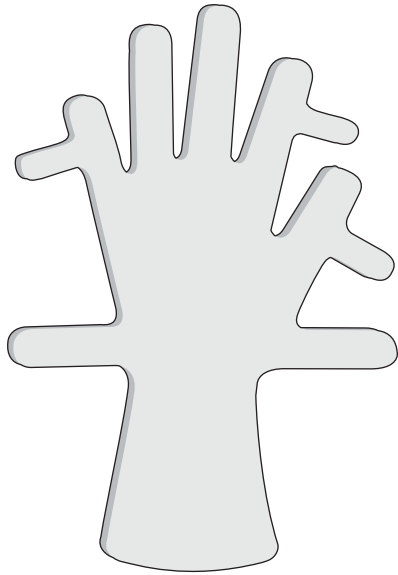

**WIS-FO-299**

F?r Erwachsene - For adults - Per adulti  
Para adultos - Pour adultes

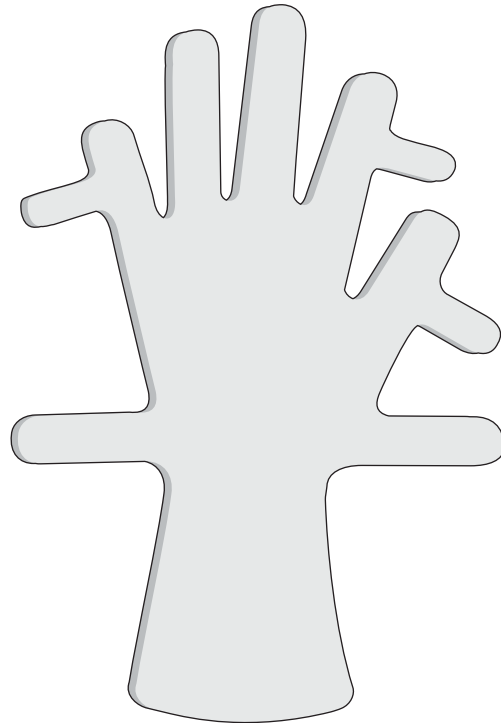

Bleih?nde  
Lead hands  
Mani di piombo  
Manos de plombo  
Main de plomb

**WIS-FO-300**

Fingerringen - Forceps for opening rings  
Pinza taglia anelli - Sierra para anillos - Scies pour bagues

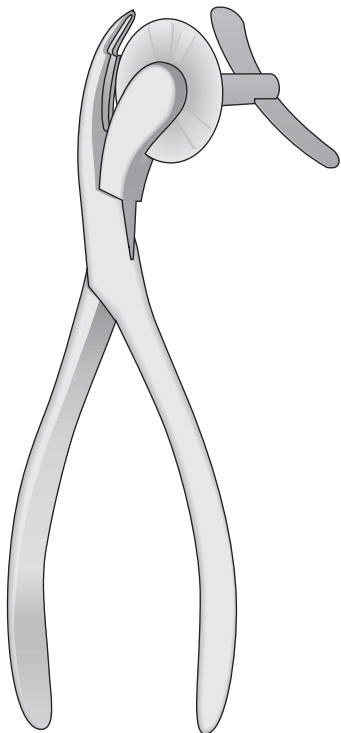

**WIS-FO-80**  
170 mm

Nagel - Ausreisszange  
Nail extracting forceps  
Pinza per estrazione delle unghie  
Pinzas para arrancar u?as  
Pince pour extraire les ongles

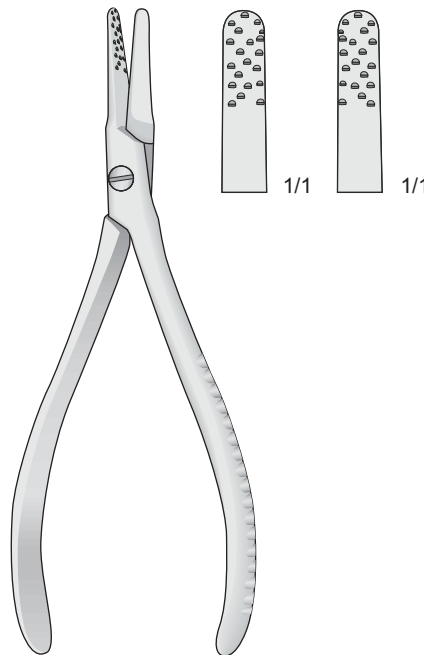

**RADOLF**  
**WIS-FO-159**  
135 mm

Nagelspaltzange  
Nail nipper  
Pinza per unghie  
Pinzas corta u?as  
Pince ? ongles

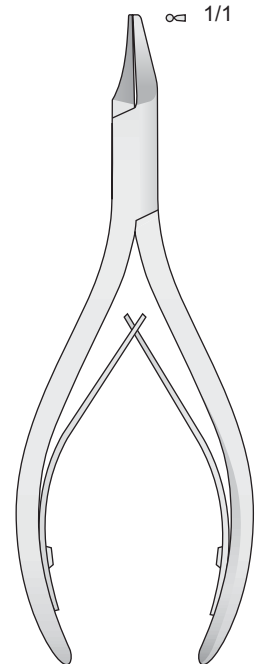

**WIS-DP-09**  
135 mm



Hohlmeißelzangen

Bone rongeurs

Pinze ossivore

Pinzas gubias

Pinces gouges

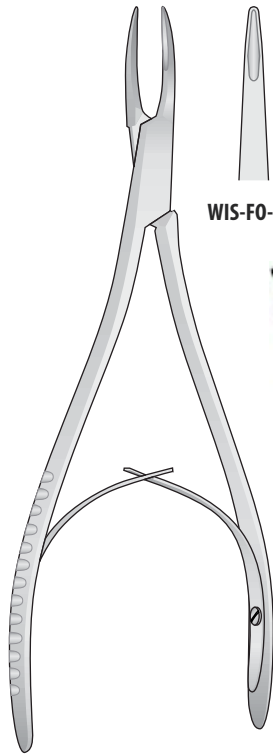

MINI-FRIEDMANN  
WIS-FO-22/WIS-FO-220  
150 mm

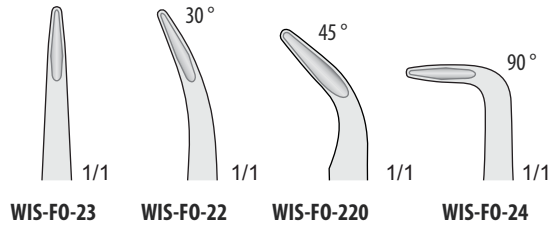

**WAA**WAA**ORTHO**  
INDUSTRY  
Sialkot Pakistan

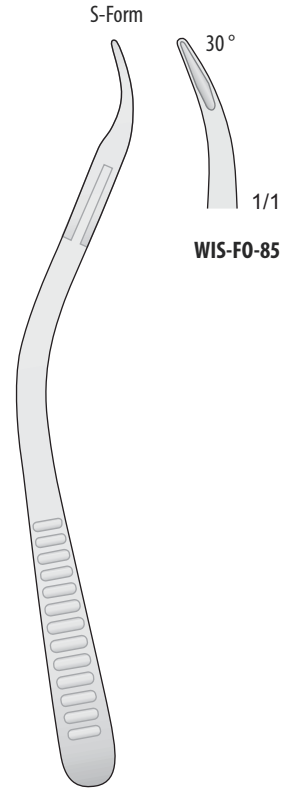

MINI-FRIEDMANN  
WIS-FO-85  
145 mm

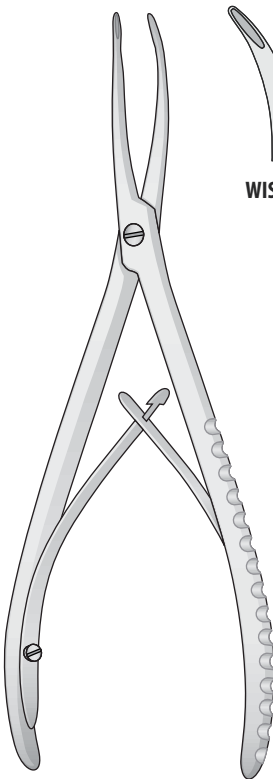

STELLBRINK  
WIS-FO-88/WIS-FO-89  
170 mm

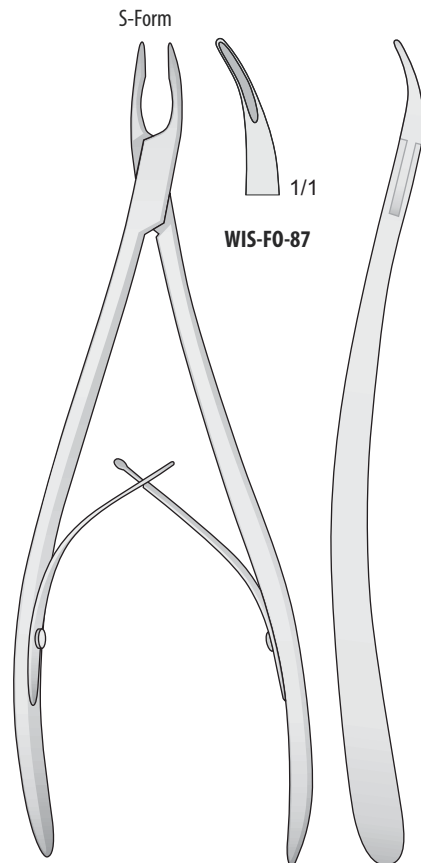
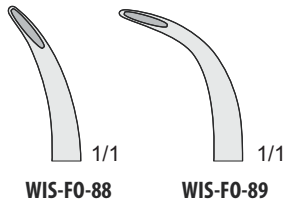

STELLBRINK  
WIS-FO-87  
190 mm

**WAA**WAA**ORTH**  
INDUSTRY  
Sialkot Pakistan

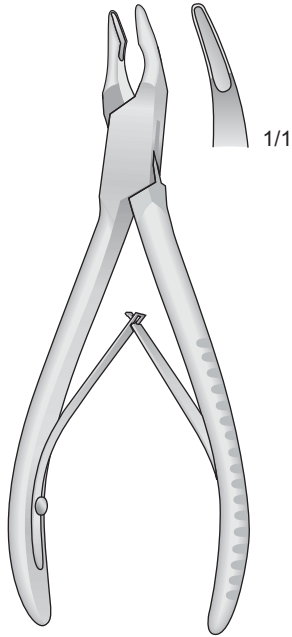

**MINI FRIEDMANN**  
**WIS-F0-15**  
120 mm

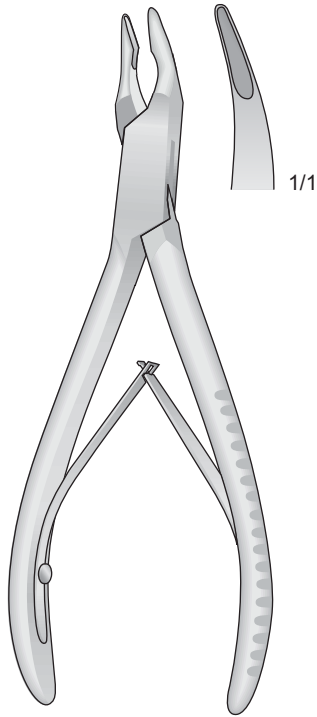

**FRIEDMANN**  
**WIS-F0-17**  
140 mm

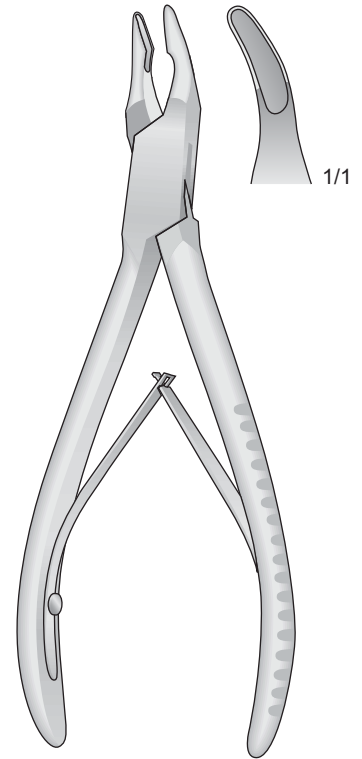

**BLUMENTHAL**  
**WIS-F0-19**  
155 mm

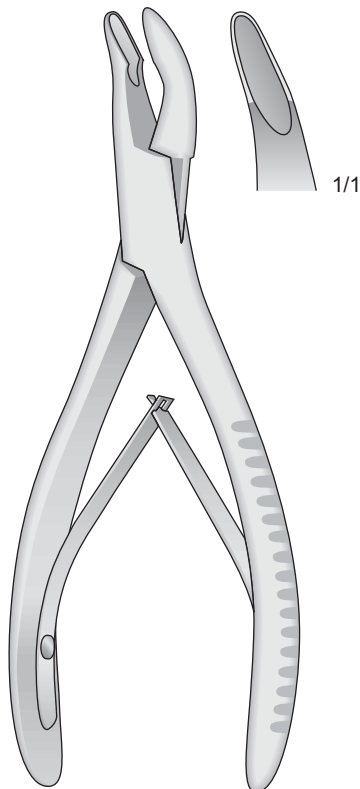

**MEAD**  
**WIS-F0-21**  
165 mm

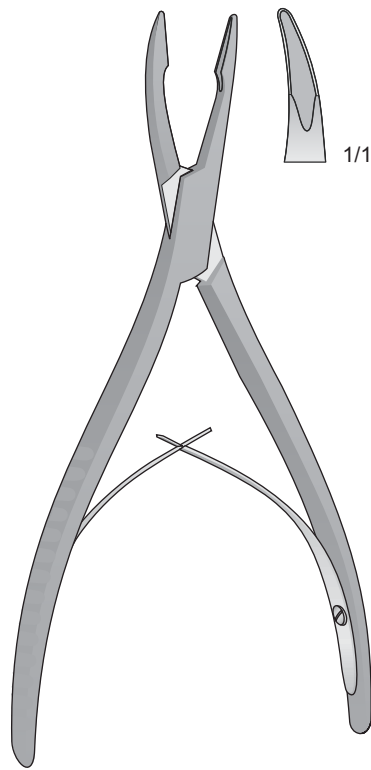

**FRIEDMANN**  
**WIS-F0-16**  
160 mm

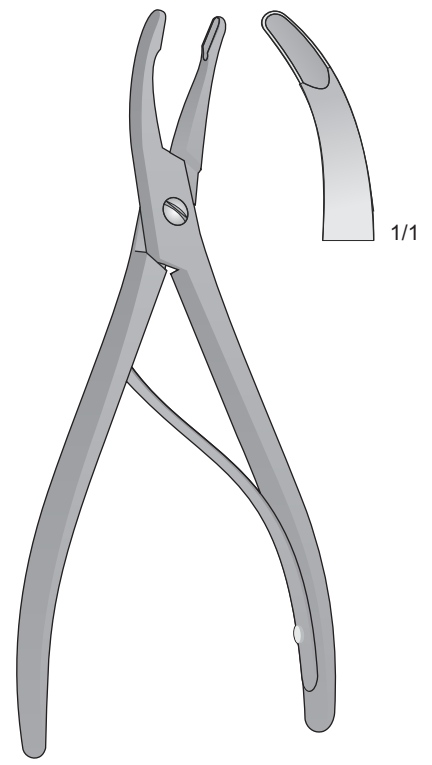

**LUER**  
**WIS-F0-18**  
155 mm

# WAAWAAORTHO INDUSTRY Sialkot Pakistan

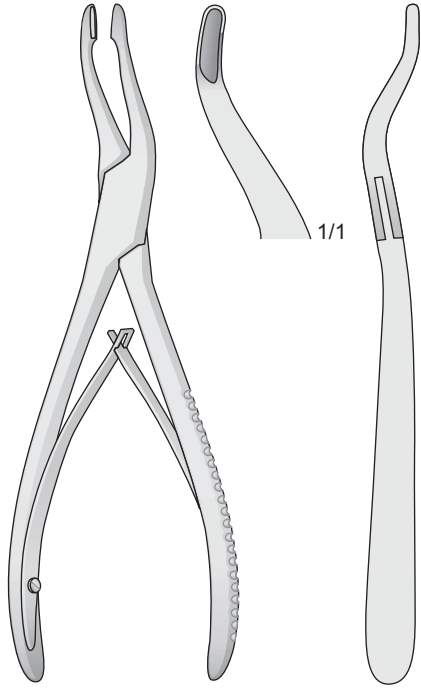

ALEXANDER  
WIS-FO-27  
140 mm

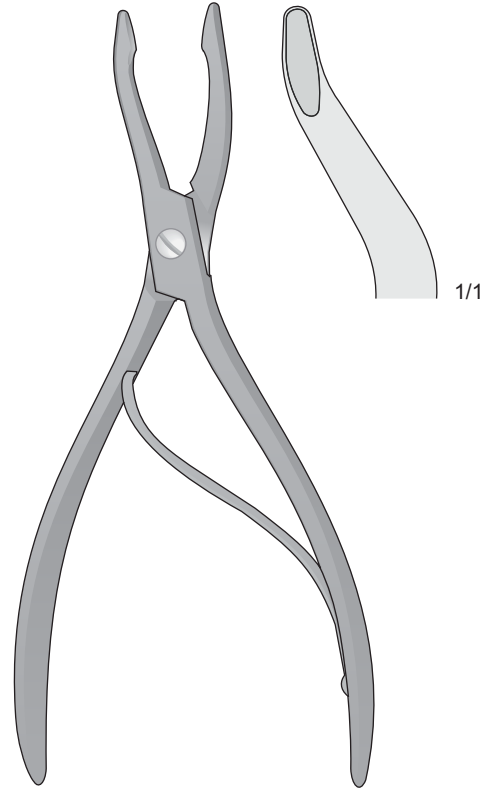

JANSEN-LEUER  
WIS-FO-10  
180 mm

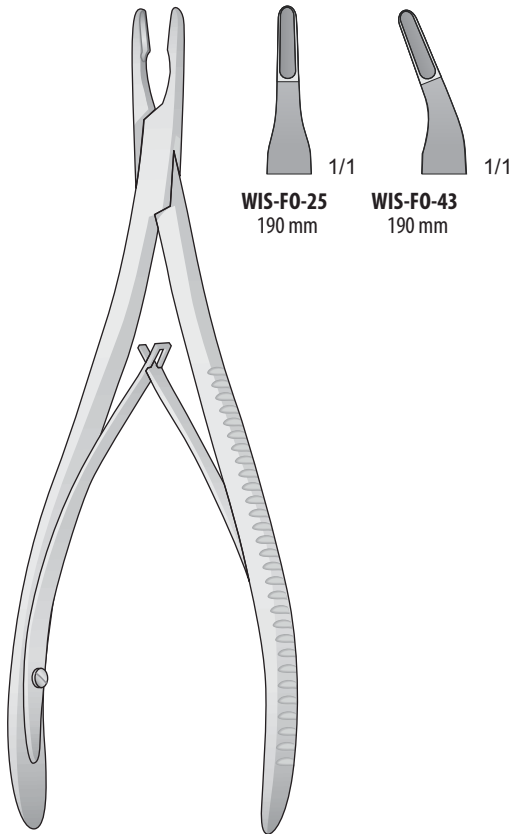

LEMPERT  
WIS-FO-25/WIS-FO-43  
190 mm

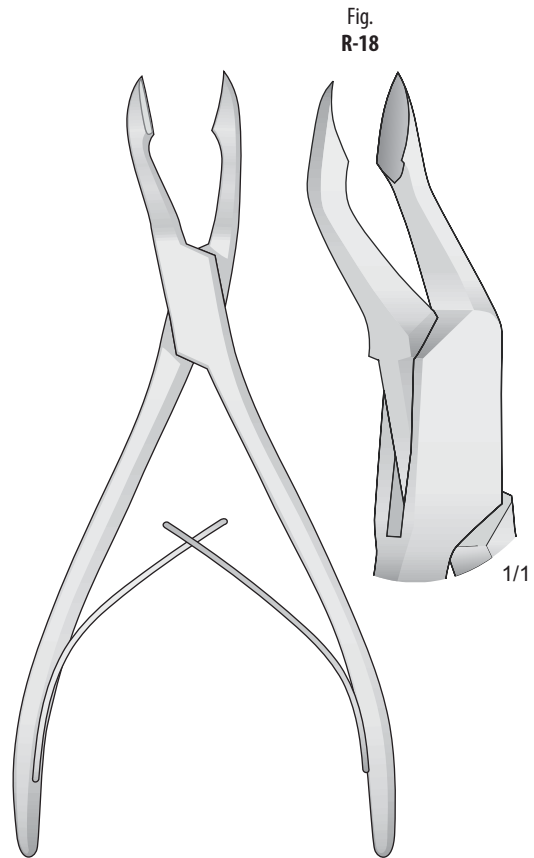

WIS-FO-33  
175 mm

**WAA**WAA**ORTH**  
INDUSTRY  
**Sialkot Pakistan**

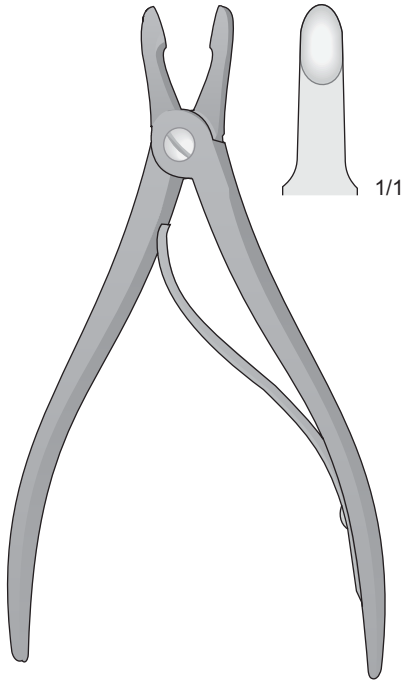

HARTMANN  
WIS-F0-14  
155 mm

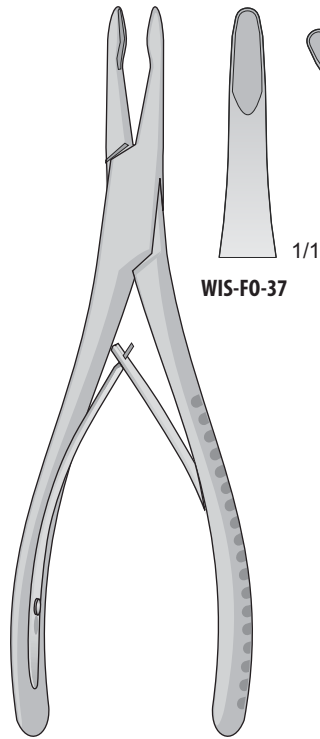

JANSEN  
WIS-F0-37/WIS-F0-39  
170 mm

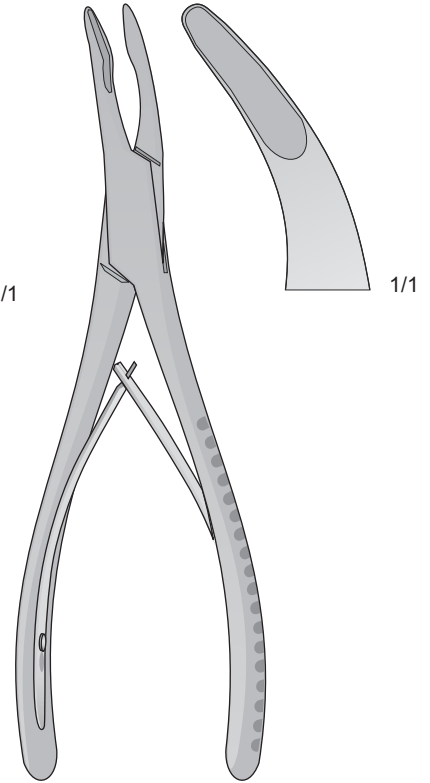

OLIVECRONA  
WIS-F0-45  
190 mm

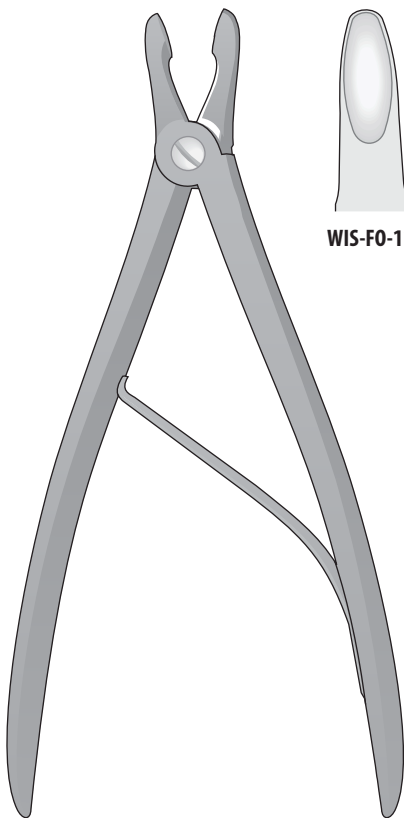

CUSHING  
WIS-F0-11/WIS-F0-12  
190 mm

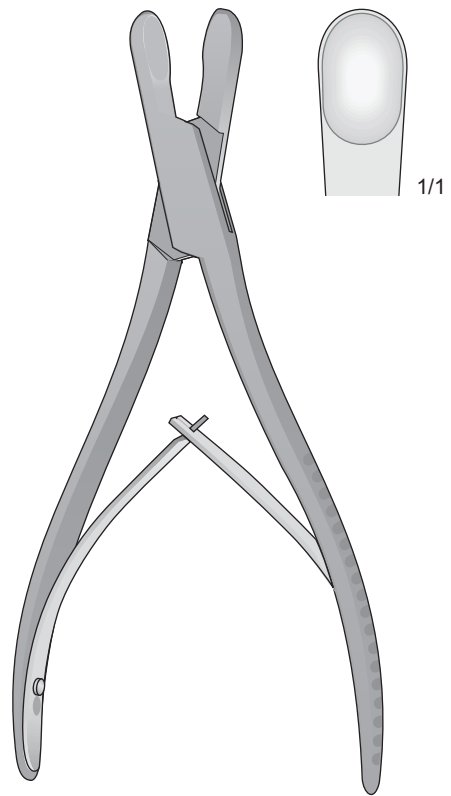
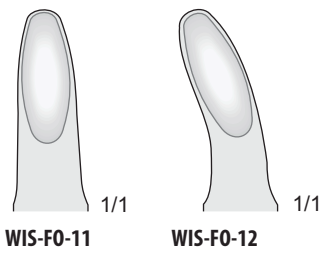

LUER-STILLE  
WIS-F0-13  
185 mm

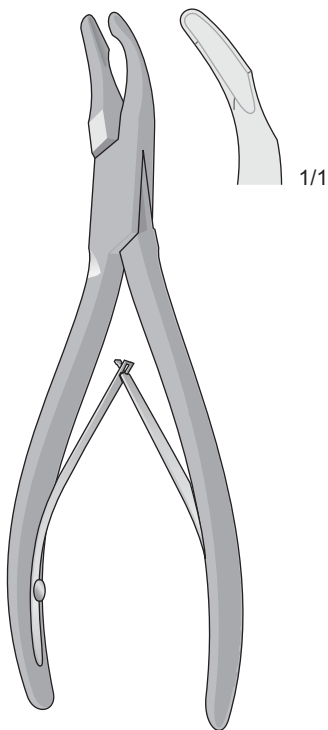

CLEVELAND  
**WIS-FO-231** 140 mm  
**WIS-FO-232** 170 mm

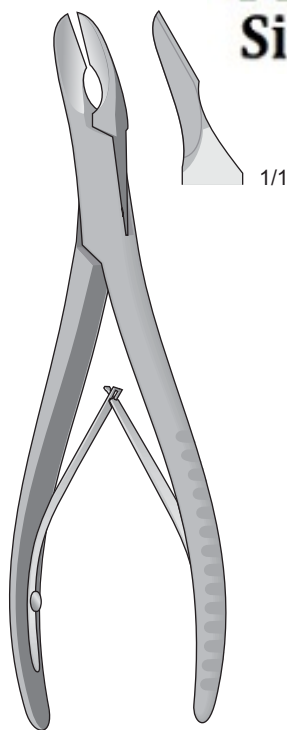

CLEVELAND  
**WIS-FO-233** 150 mm  
**WIS-FO-234** 170 mm

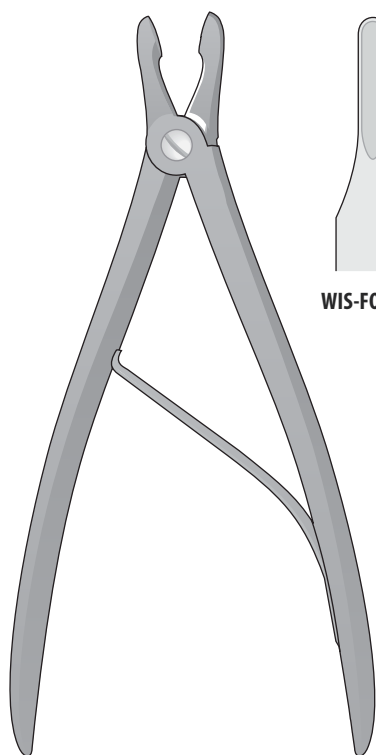

CUSHING  
**WIS-FO-107/WIS-FO-109**  
190 mm

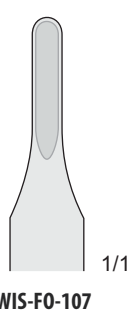

**WIS-FO-107**

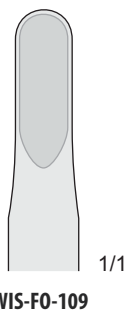

**WIS-FO-109**

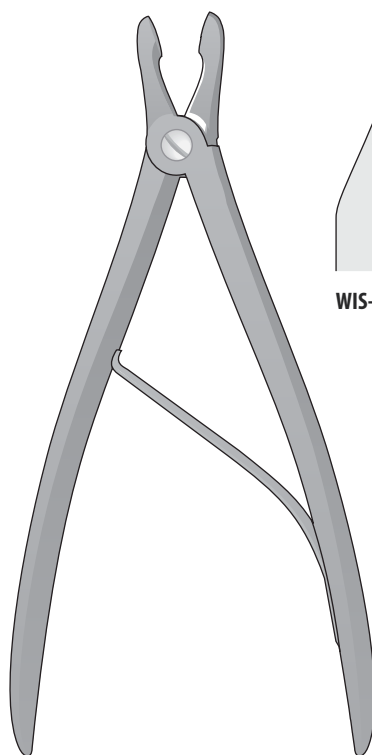

CUSHING  
**WIS-FO-147/WIS-FO-149**  
190 mm

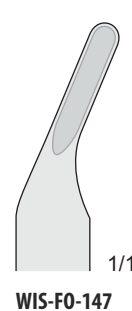

**WIS-FO-147**

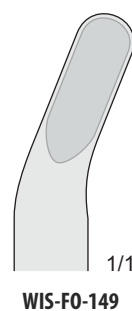

**WIS-FO-149**

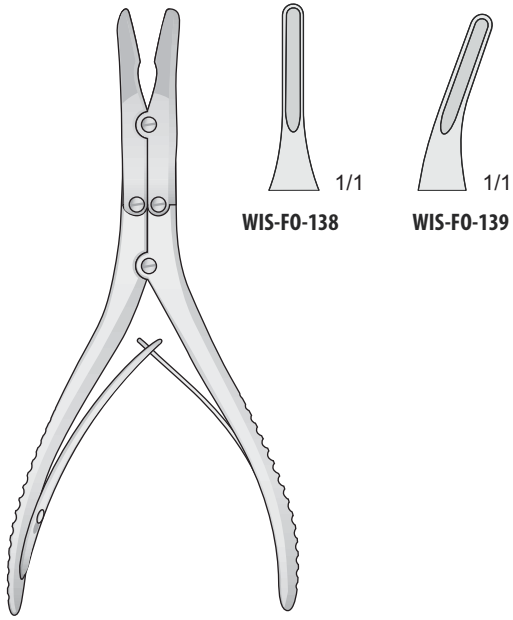

RUSKIN  
WIS-FO-138/WIS-FO-139  
150 mm

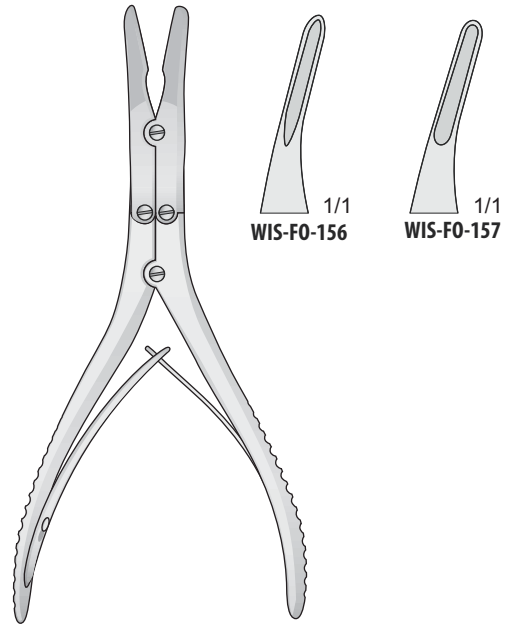

KLEINERT-KUTZ  
WIS-FO-156/WIS-FO-157  
155 mm

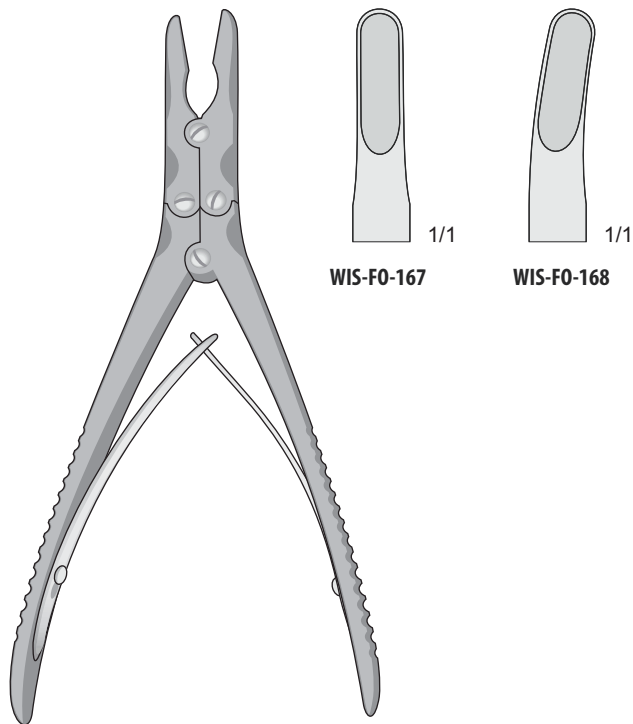

RUSKIN  
WIS-FO-167/WIS-FO-168  
185 mm

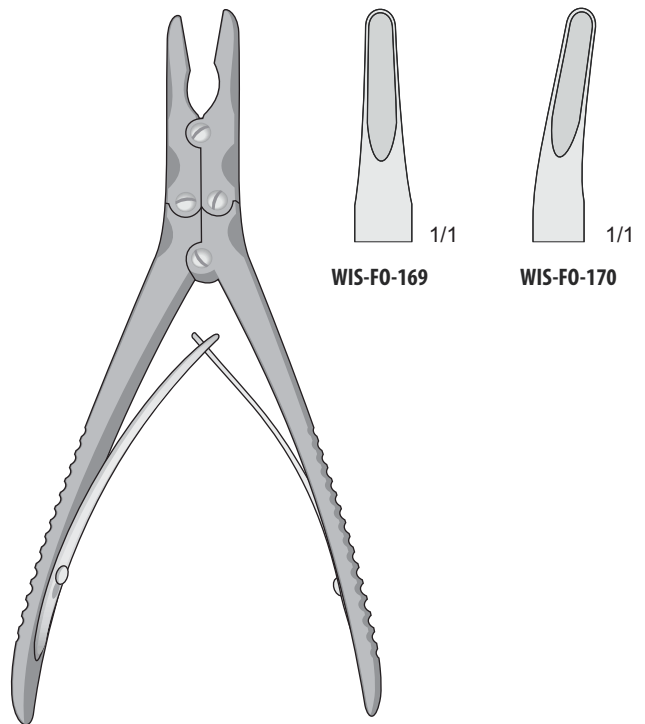

RUSKIN  
WIS-FO-169/WIS-FO-170  
185 mm

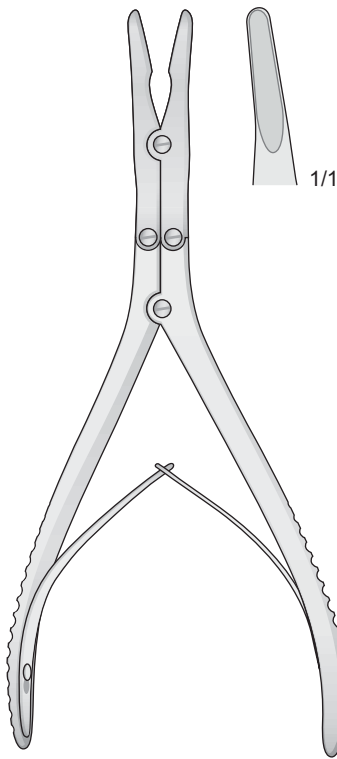

BEYER  
WIS-FO-20  
180 mm



ZUFAL-JANSEN  
WIS-FO-34  
180 mm

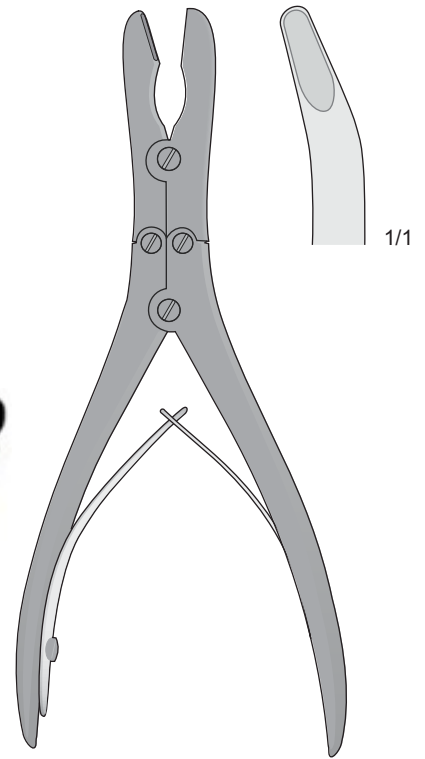

RUSKIN-STILLE  
WIS-FO-35  
180 mm

**WAA**WAAORTHO  
INDUSTRY  
Sialkot Pakistan

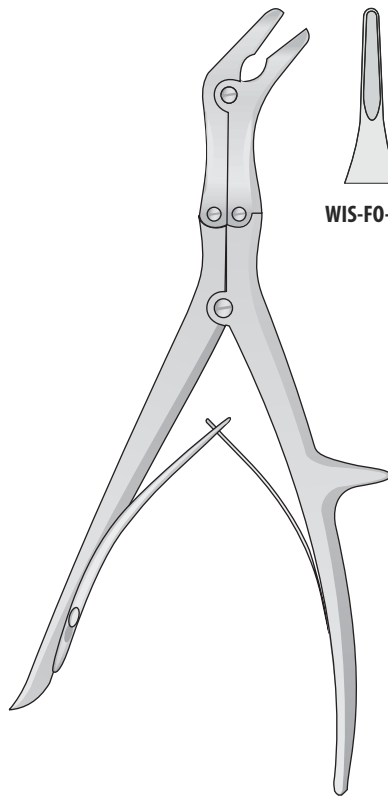

ECHLIN  
WIS-FO-28/WIS-FO-30  
230 mm

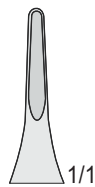

WIS-FO-28

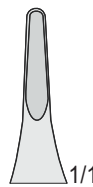

WIS-FO-29

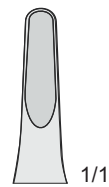

WIS-FO-30

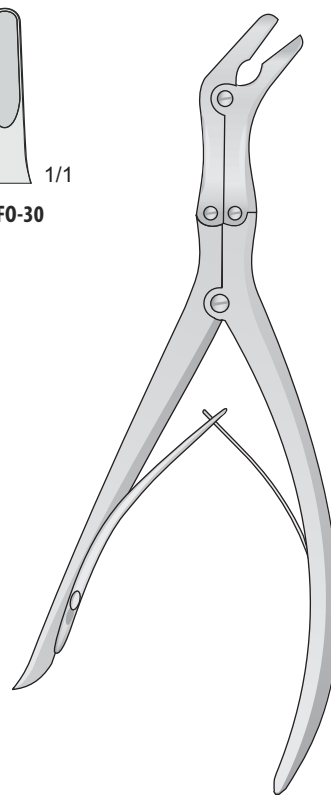

LEKSELL  
WIS-FO-31/WIS-FO-32

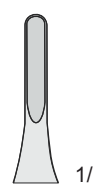

WIS-FO-31  
240 mm

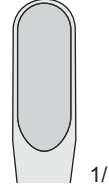

WIS-FO-32  
250 mm

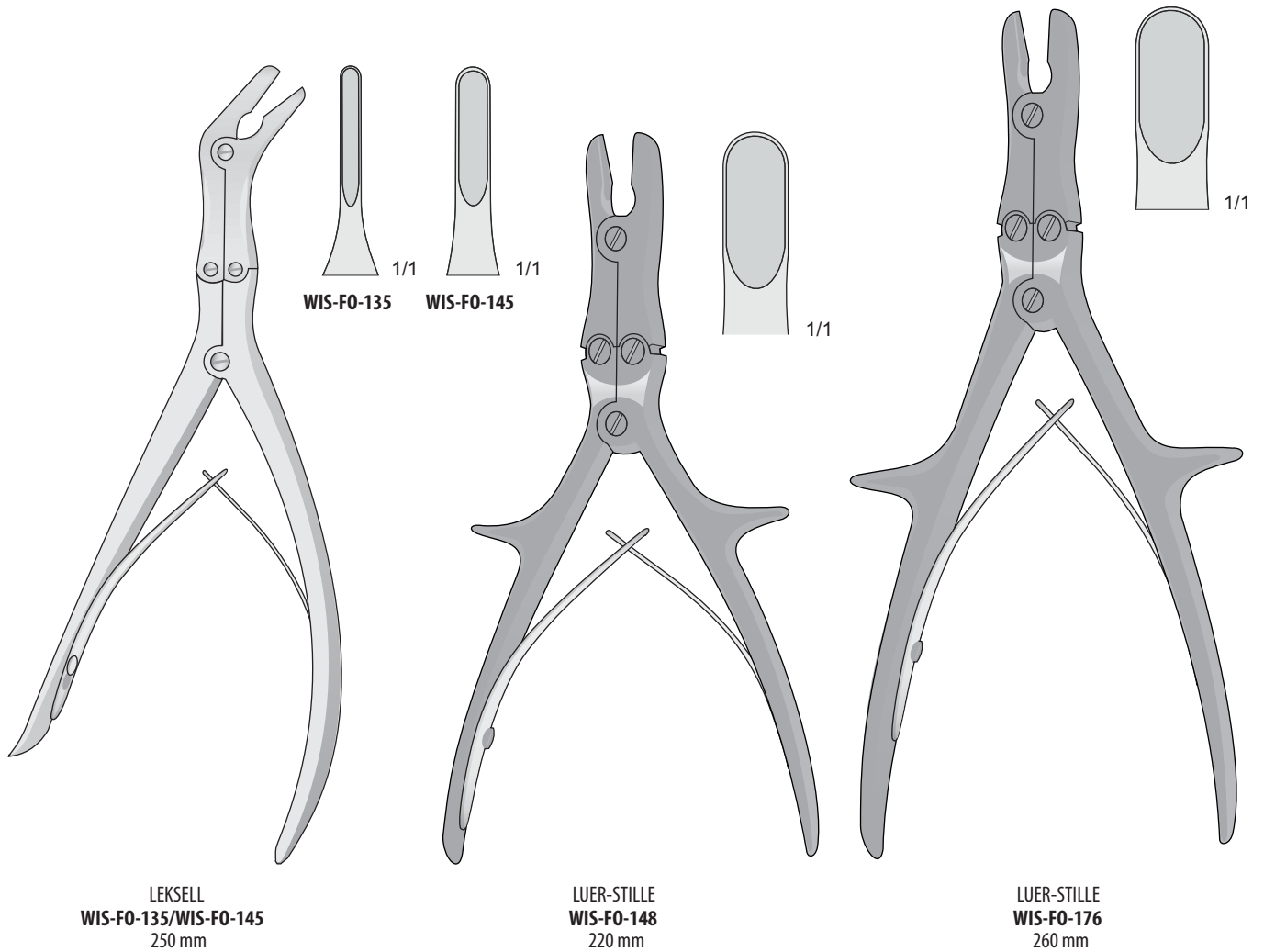



Hohlmeißelzangen

Bone rongeurs

Pinze ossivore

Pinzas gubias

Pinces gouges

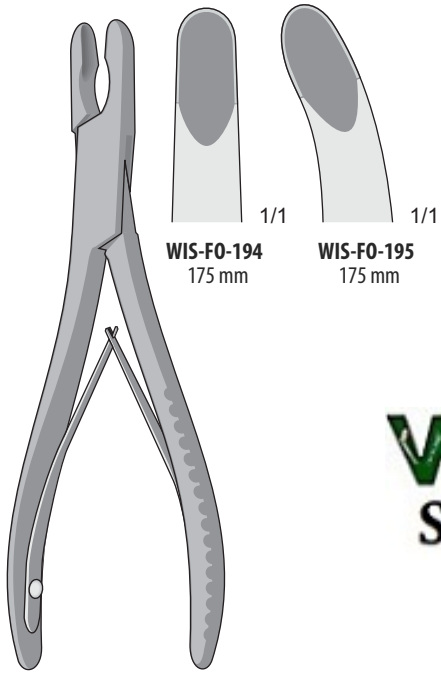

WIS-FO-194  
175 mm

WIS-FO-195  
175 mm



WIS-FO-191  
180 mm

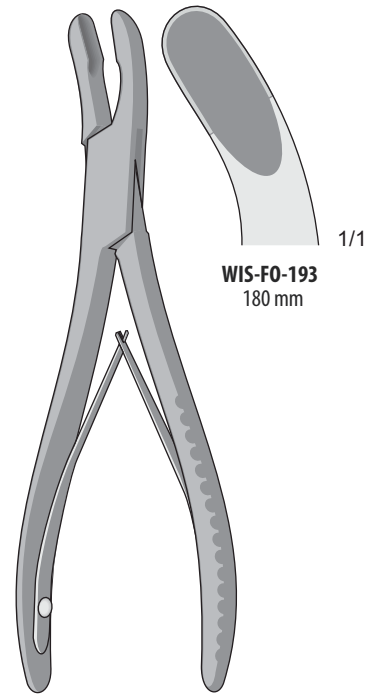

WIS-FO-193  
180 mm

**WAA**WAA**ORTHO**  
INDUSTRY  
Sialkot Pakistan

LUER  
WIS-FO-194/WIS-FO-195  
175 mm

LUER  
WIS-FO-191  
180 mm

LUER  
WIS-FO-193  
180 mm

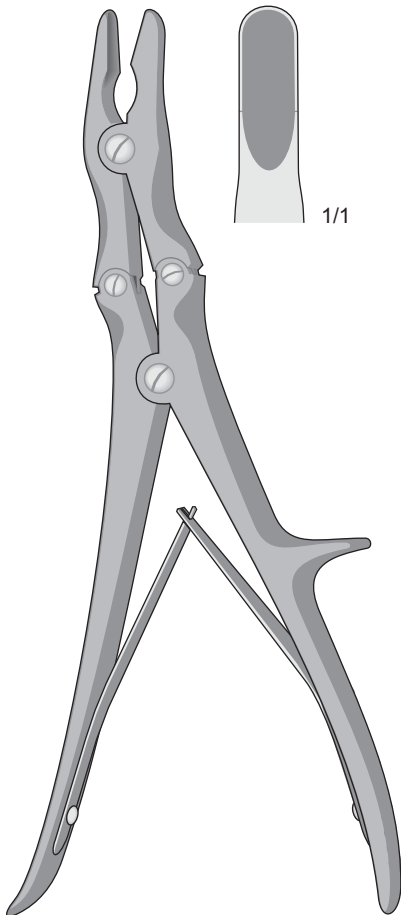

LEKSELL-STILLE  
WIS-FO-196  
240 mm

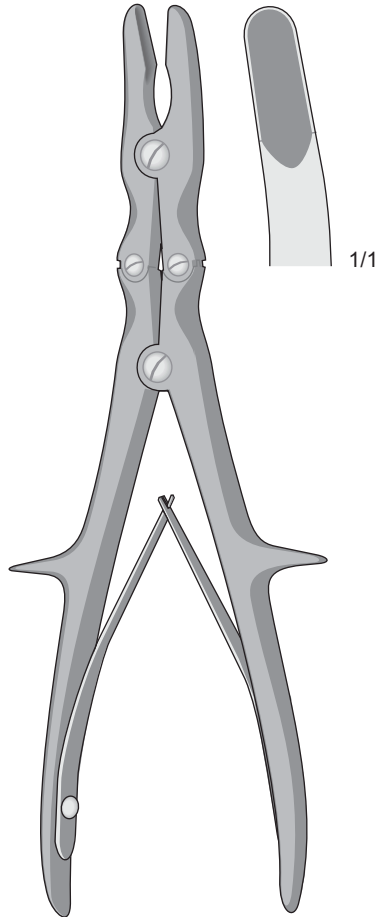

STILLE-RUSKIN  
WIS-FO-197  
240 mm

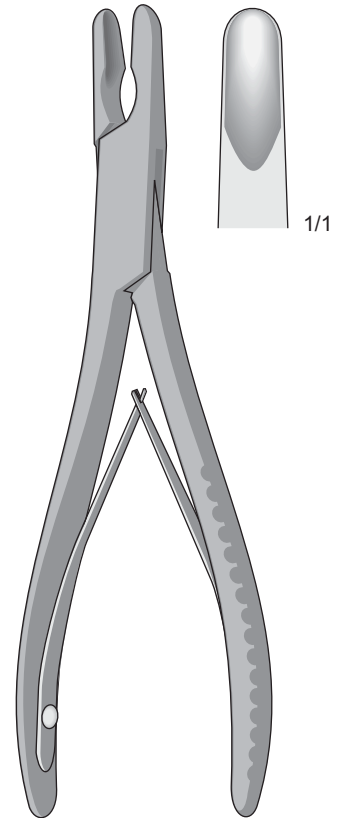

ADSON  
WIS-FO-198  
210 mm

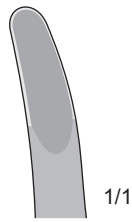
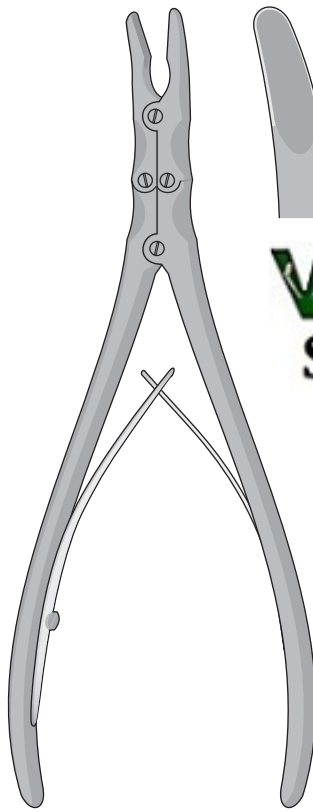

1/1

**WAAORTH O**  
INDUSTRY  
**Sialkot Pakistan**

R2TTGEN-RUSKIN  
**WIS-FO-199**  
240 mm



**WIS-FO-140**  
200 mm

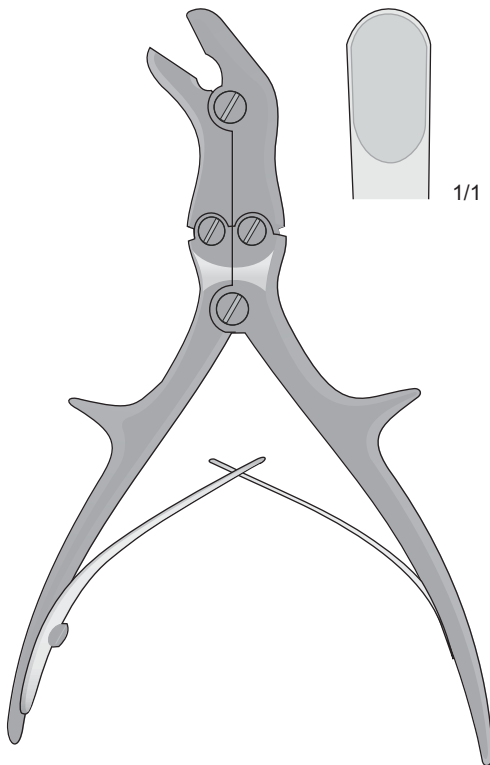

1/1

STILLE  
**WIS-FO-36**  
210 mm

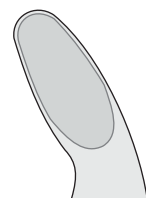
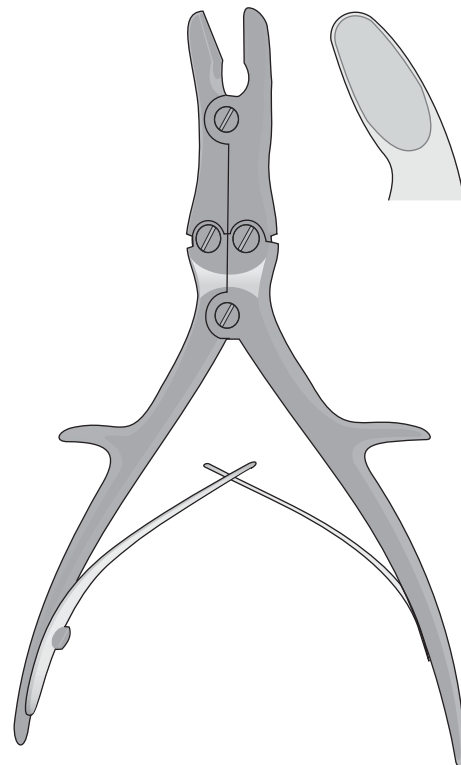

1/1

LUER-STILLE  
**WIS-FO-38**  
210 mm

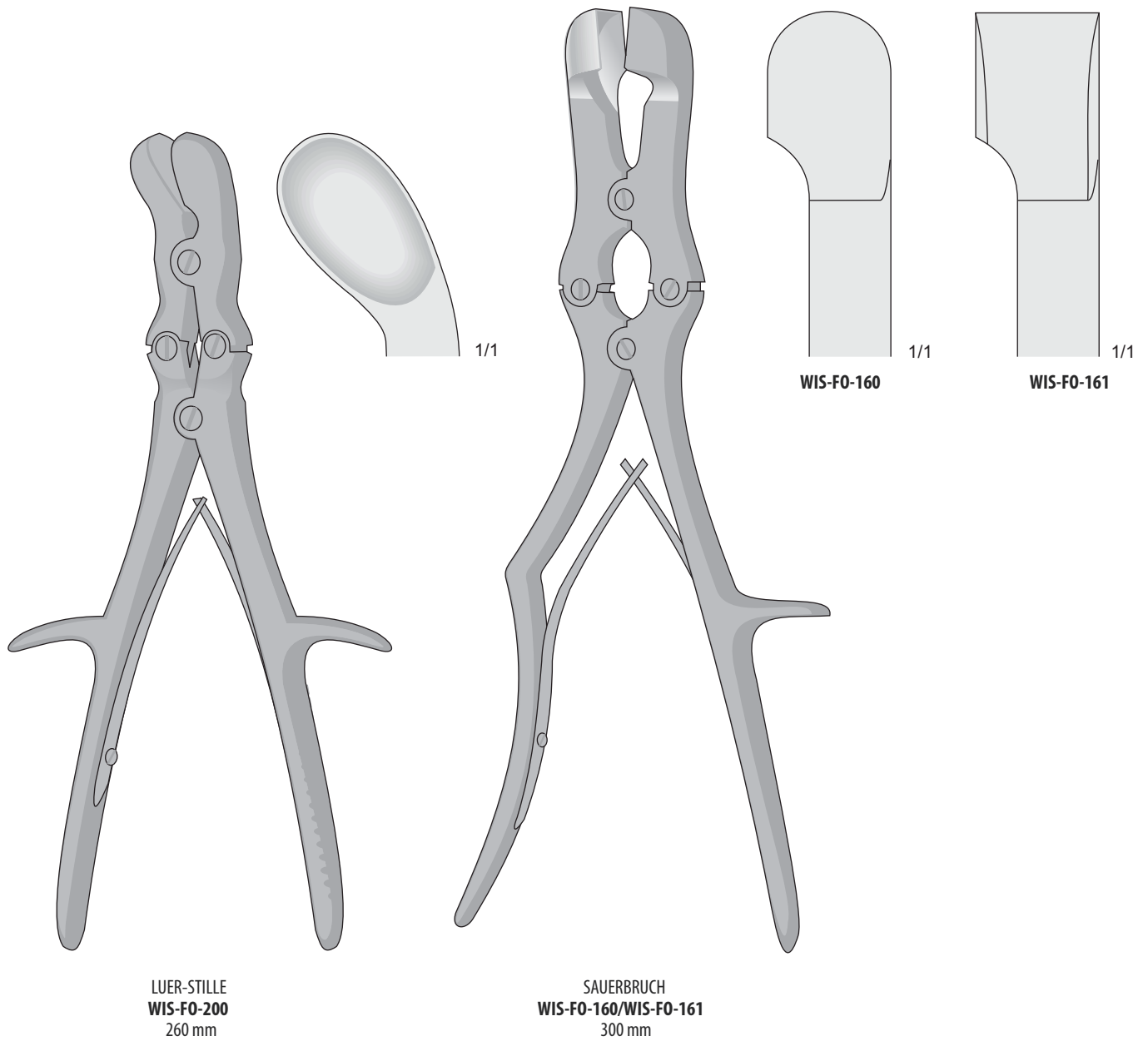

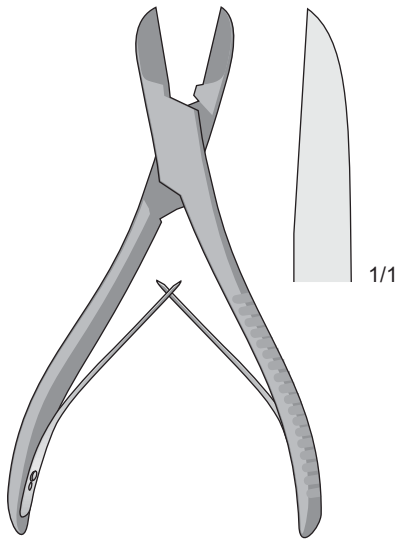

LISTON  
**WIS-LX-111**  
140 mm

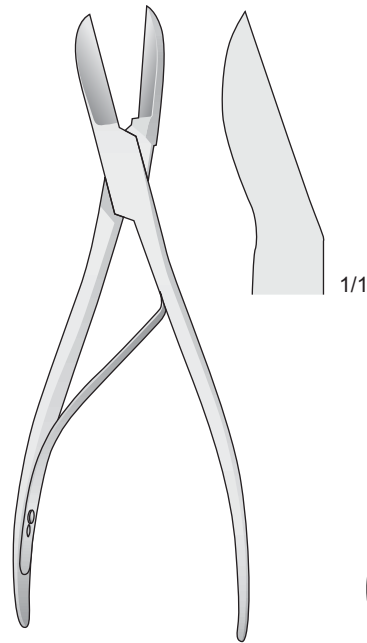

LISTON  
**WIS-LX-109**  
170 mm

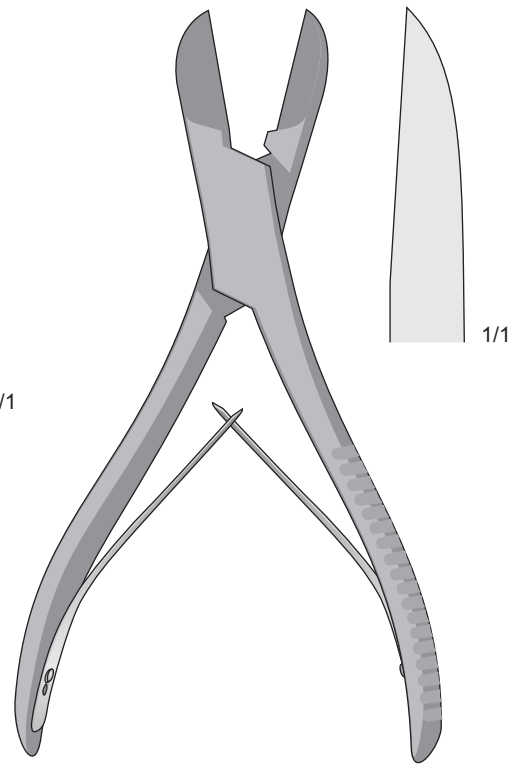

LISTON  
**WIS-LX-116**  
200 mm

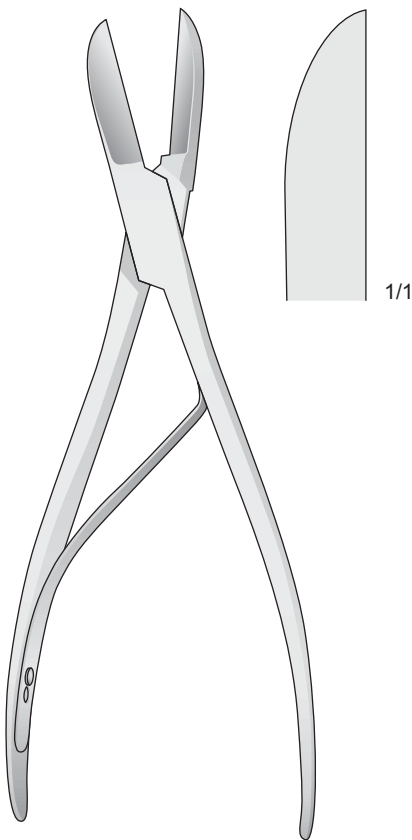

LISTON  
**WIS-LX-108**  
220 mm

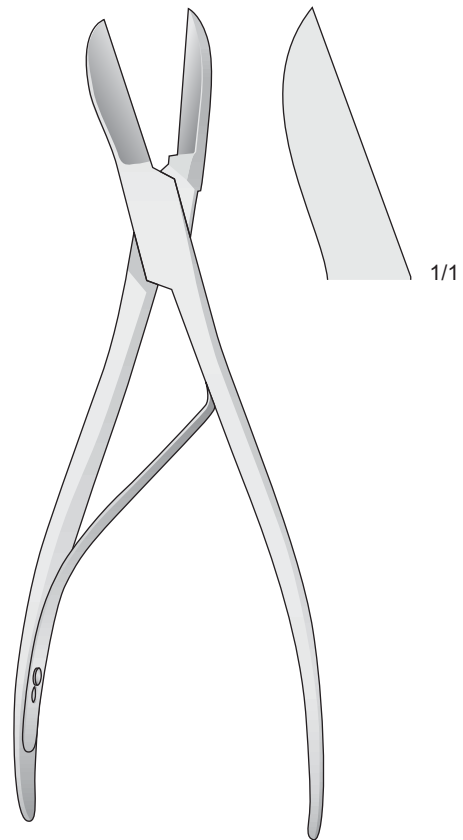

LISTON  
**WIS-LX-110**  
220 mm

# WAAORTH INDUSTRY Sialkot Pakistan

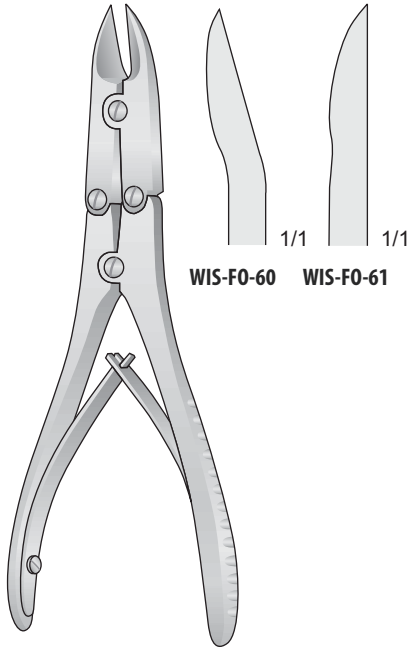

**WIS-FO-60**   **WIS-FO-61**

**B?HLER**  
**WIS-FO-60/WIS-FO-61**  
150 mm

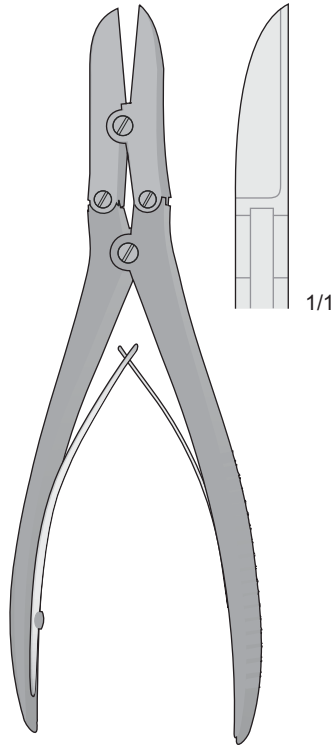

**RUSKIN-LISTON**  
**WIS-FO-108**  
190 mm

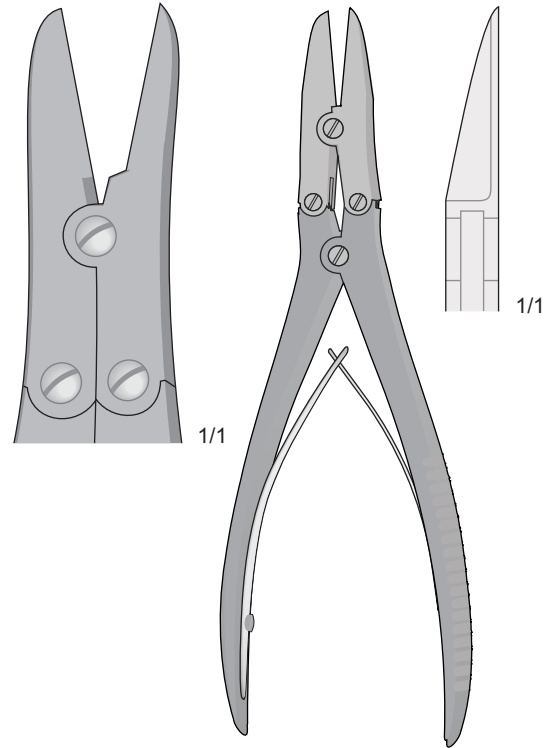

**RUSKIN-LISTON**  
**WIS-FO-178**  
190 mm

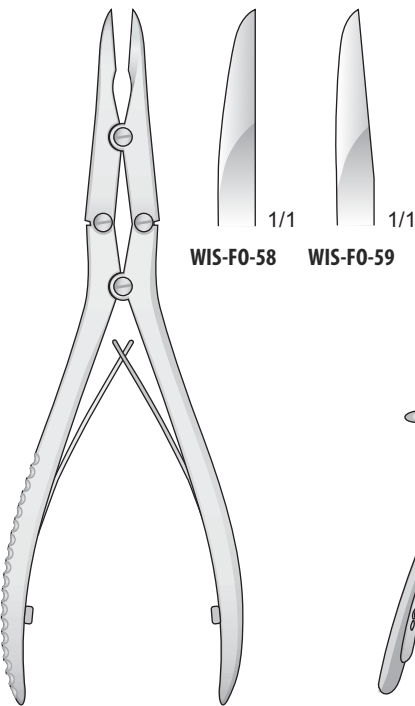

**WIS-FO-58**   **WIS-FO-59**

**WIS-FO-58/WIS-FO-59**  
180 mm

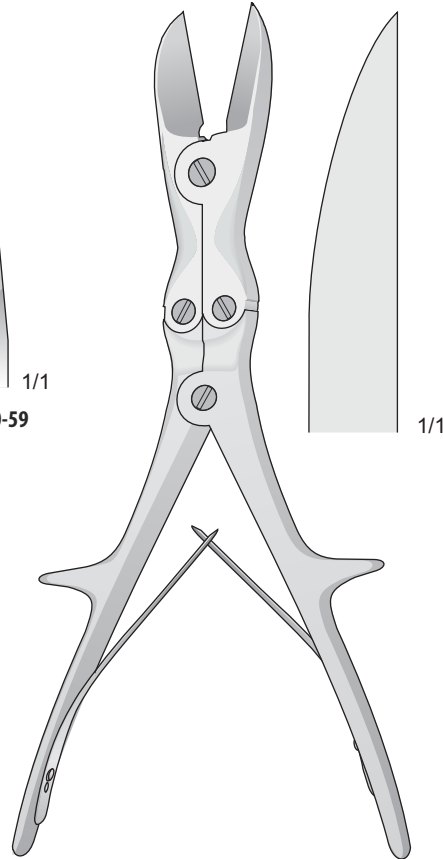

**LISTON**  
**WIS-FO-41**  
270 mm

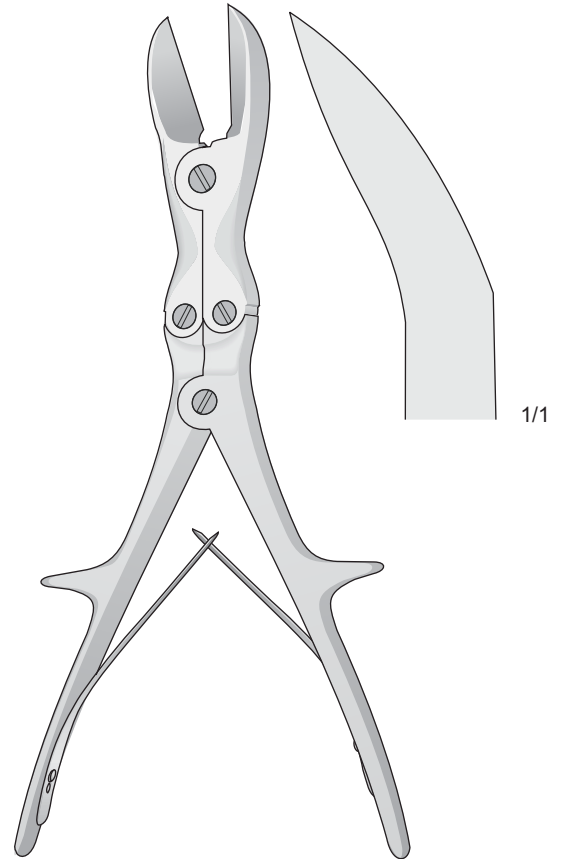

**LISTON**  
**WIS-FO-42**  
270 mm

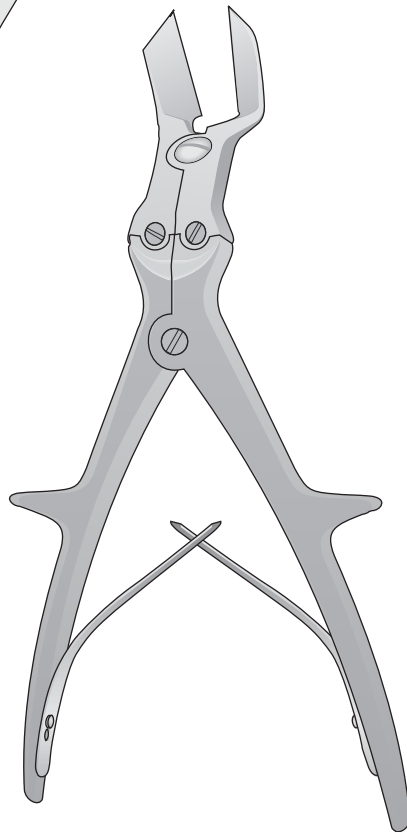
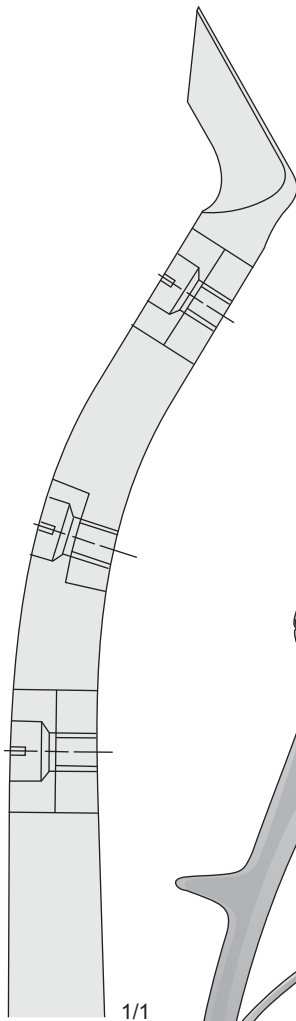

KEY-HORSLEY  
**WIS-FO-40**  
235 mm

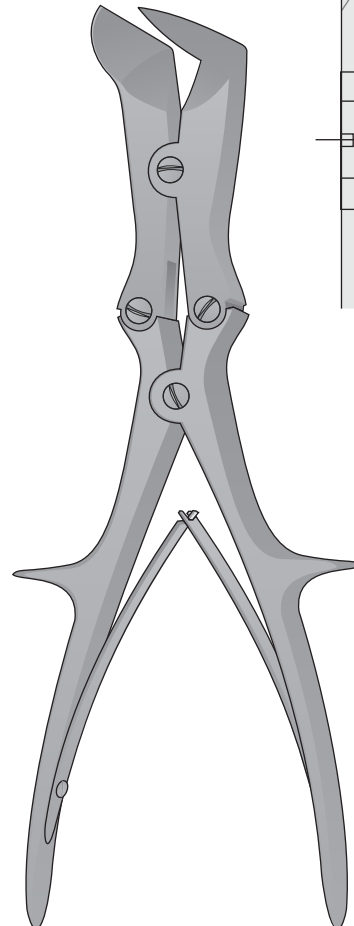
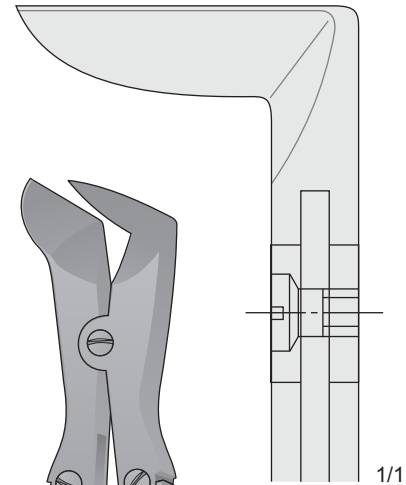

LISTON-STILLE  
**WIS-FO-158**  
265 mm

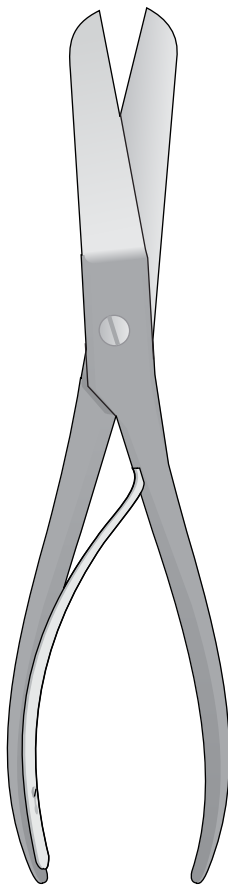

**WIS-FG-40**  
230 mm

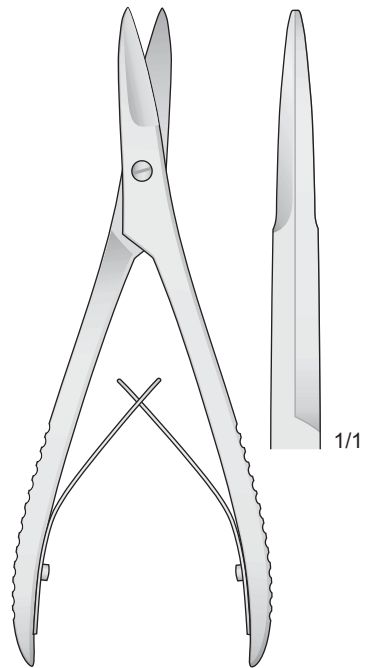
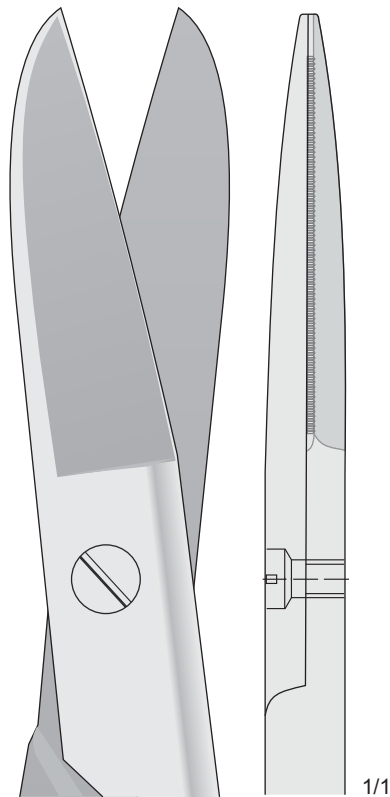

**WIS-F0-63**  
160 mm

**Wires and Nails**

Bohrdrähte und Knochennägel  
Broches et clous  
Agujas y clavos  
Fili e chiodi

**Extension Bows**

Extensionsbügel  
Étriers d'extension  
Arcos de tracción  
Archi da trazione

**Twist Drills**

Spiralbohrer  
Forets  
Brocas espirales  
Maschiatori - Taps

**Osteosintese**

Osteosynthesis  
Ostéosynthèse  
Osteosíntesis  
Osteosintesi

**Hand Drills**

Handbohrapparate  
Perceuses à main  
Perforadores manuales  
Perforatori a mano

**Screwdrivers**

Schraubendreher  
Tournevis  
Destornilladores  
Cacciaviti

**Bone surgery**

Knochenchirurgie  
Chirurgie osseuse  
Cirugía ósea  
Chirurgia ossea





## KIRSCHNER

Trokarspitze  
Trocar point  
Punta trequarti  
Punta de tr?car  
Pointe de Trocart



## KIRSCHNER

Trokarspitze  
Trocar point  
Punta trequarti  
Punta de tr?car  
Pointe de Trocart



## KIRSCHNER

Trokarspitze  
Lance point  
Punte lanceolate  
Punta lanceolar  
Pointe lancette

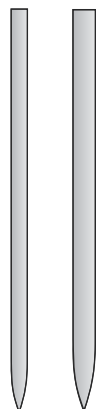

Trokarspitze  
Trocar point  
Punta trequarti  
Punta de tr?car  
Pointe de Trocart

310 mm

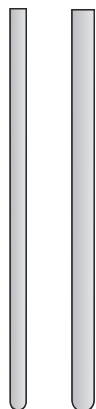

Rundes ende  
Round shaft  
Punta rotonda  
Punta redonda  
Pointe ronde

310 mm

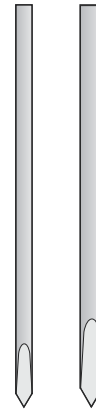

Lanzenspitze  
Lance point  
Punte lanceolate  
Punta lanceolar  
Pointe lancette

310 mm

?/Diam.	Conf. 10 pz.
0,8 mm	<b>WIS-KI-99</b>
1,0 mm	<b>WIS-KI-100</b>
1,2 mm	<b>WIS-KI-102</b>
1,4 mm	<b>WIS-KI-114</b>
1,5 mm	<b>WIS-KI-115</b>
1,6 mm	<b>WIS-KI-116</b>
1,7 mm	<b>WIS-KI-117</b>
1,8 mm	<b>WIS-KI-118</b>
2,0 mm	<b>WIS-KI-120</b>
2,2 mm	<b>WIS-KI-122</b>
2,5 mm	<b>WIS-KI-125</b>
3,0 mm	<b>WIS-KI-130</b>

?/Diam.	Conf. 10 pz.
0,8 mm	<b>WIS-KI-00</b>
1,0 mm	<b>WIS-KI-01</b>
1,2 mm	<b>WIS-KI-02</b>
1,4 mm	<b>WIS-KI-14</b>
1,5 mm	<b>WIS-KI-15</b>
1,6 mm	<b>WIS-KI-16</b>
1,7 mm	<b>WIS-KI-17</b>
1,8 mm	<b>WIS-KI-18</b>
2,0 mm	<b>WIS-KI-20</b>
2,2 mm	<b>WIS-KI-22</b>
2,5 mm	<b>WIS-KI-25</b>
3,0 mm	<b>WIS-KI-30</b>

?/Diam.	Conf. 10 pz.
0,8 mm	<b>WIS-KI-40</b>
1,0 mm	<b>WIS-KI-41</b>
1,2 mm	<b>WIS-KI-42</b>
1,5 mm	<b>WIS-KI-43</b>
1,6 mm	<b>WIS-KI-44</b>
1,8 mm	<b>WIS-KI-45</b>
2,0 mm	<b>WIS-KI-46</b>
2,2 mm	<b>WIS-KI-47</b>
2,5 mm	<b>WIS-KI-48</b>
3,0 mm	<b>WIS-KI-49</b>



KIRSCHNER

Trokarspitze  
Trocar point  
Punta trequarti  
Punta de tr?car  
Pointe de Trocart



KIRSCHNER

Trokarspitze  
Trocar point  
Punta trequarti  
Punta de tr?car  
Pointe de Trocart



KIRSCHNER

Lanzenspitze  
Lance point  
Punte lanceolate  
Punta lanceolar  
Pointe lancette

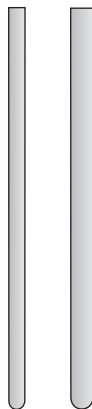

Rundes ende  
Round shaft  
Punta rotonda  
Punta redonda  
Pointe ronde

150 mm

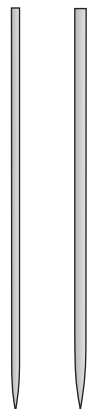

Trokarspitze  
Trocar point  
Punta trequarti  
Punta de tr?car  
Pointe de Trocart

150 mm

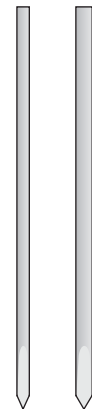

Lanzenspitze  
Lance point  
Punte lanceolate  
Punta lanceolar  
Pointe lancette

150 mm

?/Diam.	Conf. 10 pz.
0,8 mm	<b>WIS-KI-69</b>
1,0 mm	<b>WIS-KI-70</b>
1,2 mm	<b>WIS-KI-72</b>
1,4 mm	<b>WIS-KI-74</b>
1,5 mm	<b>WIS-KI-75</b>
1,6 mm	<b>WIS-KI-76</b>
1,7 mm	<b>WIS-KI-77</b>
1,8 mm	<b>WIS-KI-78</b>
2,0 mm	<b>WIS-KI-80</b>
2,2 mm	<b>WIS-KI-82</b>
2,5 mm	<b>WIS-KI-85</b>
3,0 mm	<b>WIS-KI-90</b>

?/Diam.	Conf. 10 pz.
0,8 mm	<b>WIS-KI-60</b>
1,0 mm	<b>WIS-KI-61</b>
1,2 mm	<b>WIS-KI-62</b>
1,4 mm	<b>WIS-KI-63</b>
1,6 mm	<b>WIS-KI-64</b>
1,8 mm	<b>WIS-KI-65</b>
2,0 mm	<b>WIS-KI-66</b>
2,2 mm	<b>WIS-KI-67</b>
2,5 mm	<b>WIS-KI-68</b>
3,0 mm	<b>WIS-KI-71</b>

?/Diam.	Conf. 10 pz.
0,8 mm	<b>WIS-KI-29</b>
1,0 mm	<b>WIS-KI-31</b>
1,2 mm	<b>WIS-KI-32</b>
1,5 mm	<b>WIS-KI-33</b>
1,6 mm	<b>WIS-KI-34</b>
1,8 mm	<b>WIS-KI-35</b>
2,0 mm	<b>WIS-KI-36</b>
2,2 mm	<b>WIS-KI-37</b>
2,5 mm	<b>WIS-KI-38</b>
3,0 mm	<b>WIS-KI-39</b>

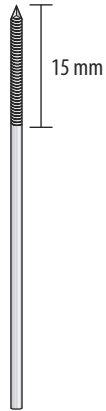

15 mm

Mit Gewinde  
With thread  
Con ?lettatura  
Con rosca  
Avec ?letage



Runde  
Round  
Rotonda  
Redonda  
Ronde

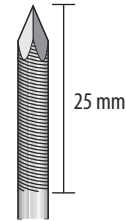

25 mm

Trokarspitze  
Trocar point  
Punta tre quarti  
Punta de tr?car  
Pointe de Trocart



Mit rundem Ende  
With round shaft  
Con punta rotonda  
Con v?stago redondo  
A? extr?mit? ronde



KIRSCHNER			
Codice	MM	Lung.	Lung.?lo
WIS-KI-220	1,5	150	5
WIS-KI-221	1.6	150	15
WIS-KI-222	2	150	15
WIS-KI-223	2	200	15

KIRSCHNER			
Codice	MM	Lung.	Lung.?lo
WIS-KI-224	2,5	200	25
WIS-KI-225	2,5	230	25
WIS-KI-226	2,5	300	25
WIS-KI-227	3,0	300	25
WIS-KI-228	3,5	300	25
WIS-KI-229	4,0	260	25
WIS-KI-233	2,5	300	25

KIRSCHNER

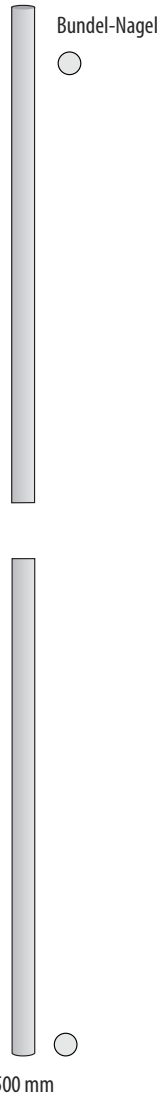

Steinmann pins



K?ntscher

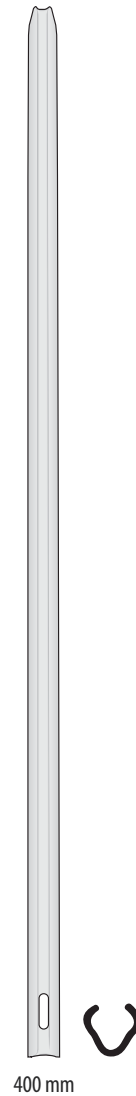

Threaded Steinmann Pins

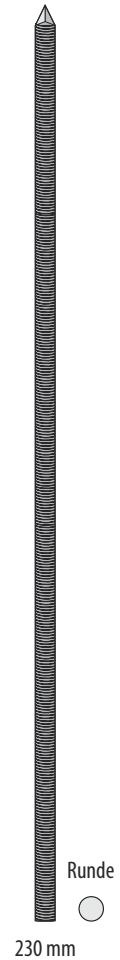

*/Diam.	Conf. 10 pz.
2,0 mm	<b>WIS-KI-50</b>
2,5 mm	<b>WIS-KI-51</b>
3,0 mm	<b>WIS-KI-52</b>
3,5 mm	<b>WIS-KI-53</b>
4,0 mm	<b>WIS-KI-54</b>
4,5 mm	<b>WIS-KI-55</b>
5,0 mm	<b>WIS-KI-56</b>
5,5 mm	<b>WIS-KI-57</b>
6,0 mm	<b>WIS-KI-58</b>

*/Diam.	Conf. 1 pz.
3,5 mm	<b>WIS-KI-280</b>
4,0 mm	<b>WIS-KI-282</b>
4,5 mm	<b>WIS-KI-284</b>
5,0 mm	<b>WIS-KI-286</b>
6,0 mm	<b>WIS-KI-288</b>
6,5 mm	<b>WIS-KI-290</b>

*/Diam.	Conf. 1 pz.
6,0 mm	<b>WIS-KI-252</b>
7,0 mm	<b>WIS-KI-254</b>
8,0 mm	<b>WIS-KI-256</b>
9,0 mm	<b>WIS-KI-258</b>
10 mm	<b>WIS-KI-260</b>
11 mm	<b>WIS-KI-262</b>
12 mm	<b>WIS-KI-264</b>

*/Diam.	Conf. 1 pz.
2,0 mm	<b>WIS-KI-160</b>
2,5 mm	<b>WIS-KI-161</b>

Negativo

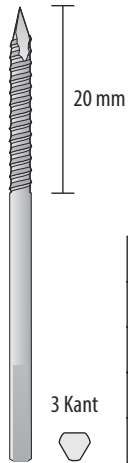

SCHANZ			
Codice	MM	Lung.	Lung. ?lo
WIS-KI-230	3	60	20
WIS-KI-231	3	80	20
WIS-KI-232	4	60	20

Negativo

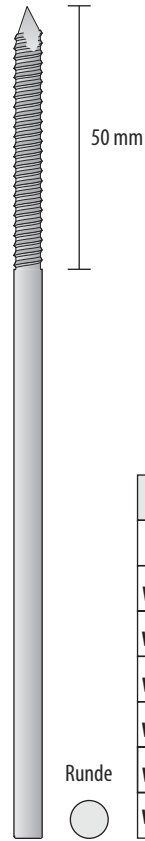

SCHANZ			
Codice	MM	Lung.	Lung. ?lo
WIS-KI-293	2	150	50
WIS-KI-294	3	150	50
WIS-KI-295	3,5	150	50
WIS-KI-296	4	150	50
WIS-KI-297	4,5	150	50
WIS-KI-298	5	150	50

Negativo

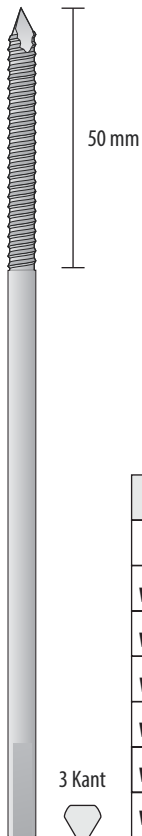

SCHANZ			
Codice	MM	Lung.	Lung. ?lo
WIS-KI-238	2	150	50
WIS-KI-240	3	150	50
WIS-KI-242	3,5	150	50
WIS-KI-244	4	150	50
WIS-KI-246	4,5	150	50
WIS-KI-248	5	150	50

Positivo

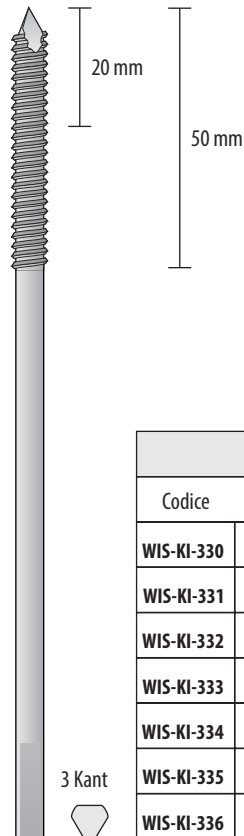

Thread - ? is 0,5 mm  
more than pin - ?

SCHANZ			
Codice	MM	Lung.	Lung. ?lo
WIS-KI-330	2	150	50
WIS-KI-331	3	150	50
WIS-KI-332	3,5	150	50
WIS-KI-333	4	150	50
WIS-KI-334	4	150	50
WIS-KI-335	4,5	150	50
WIS-KI-336	5	150	50

Steinmann Pins with Central Thread with Trocar Point

Bohrdrahtspender  
Contentitore per  
sterilizzazione Kirschner



**Positivo**

Thread -  $\varnothing$  is 0,5 mm  
more than pin -  $\varnothing$

3 Kant



STEINMANN PINS		
Codice	MM	Lung.
WIS-KI-175	3	150
WIS-KI-176	3	180
WIS-KI-177	3	200
WIS-KI-178	3	230
WIS-KI-179	3,5	150
WIS-KI-180	3,5	180
WIS-KI-181	3,5	200
WIS-KI-182	3,5	230
WIS-KI-183	4	150
WIS-KI-184	4	180
WIS-KI-185	4	200
WIS-KI-186	4	230
WIS-KI-187	4	250
WIS-KI-188	4,5	150
WIS-KI-189	4,5	180
WIS-KI-190	4,5	200
WIS-KI-191	4,5	230
WIS-KI-192	4,5	250
WIS-KI-193	4,5	300
WIS-KI-194	5	150
WIS-KI-195	5	180
WIS-KI-196	5	200
WIS-KI-197	5	230
WIS-KI-198	5	250
WIS-KI-199	5	300

$\varnothing$  10 mm

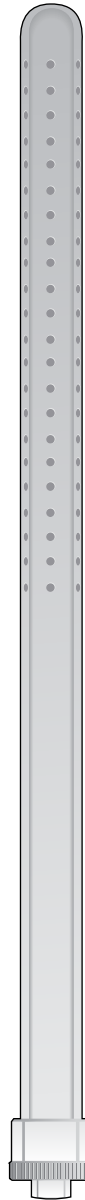

**WIS-KI-300**  
320 mm  
**WIS-KI-301**  
190 mm

Bis ? 3 mm  
Up to ? 3 mm  
Fino a ? 3 mm

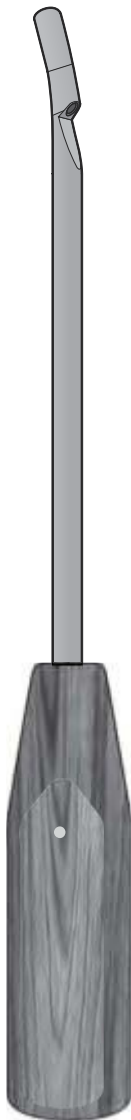

WAGNER  
**WIS-LS-106**  
300 mm

Extraktionshaken  
Extraction hooks  
Gancio d'estrazione  
Ganchos extractores  
Crochets d'extraction

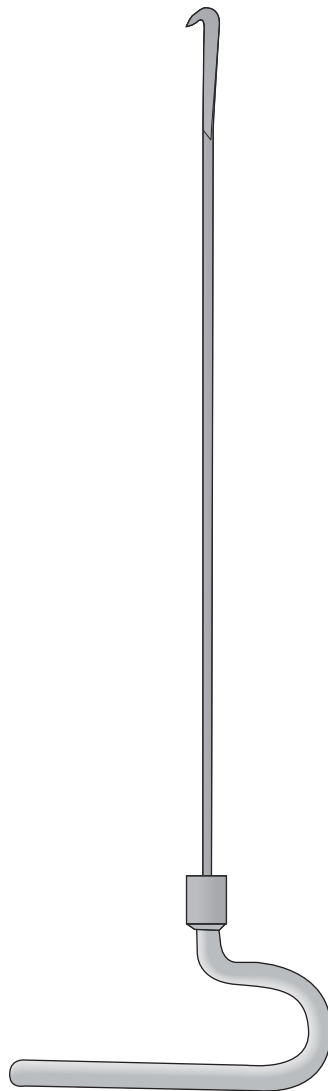

**WIS-KI-306** - 290 mm  
**WIS-KI-307** - 370 mm  
**WIS-KI-308** - 420 mm

? Int. 2,5 mm



? Int. 1,2 mm

**WIS-LS-100**  
120 mm

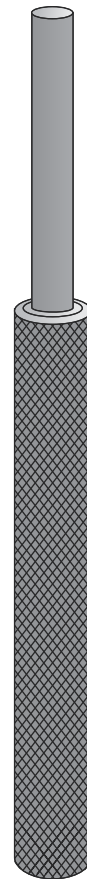

K?NTSCHER  
**FK-09**  
210 mm

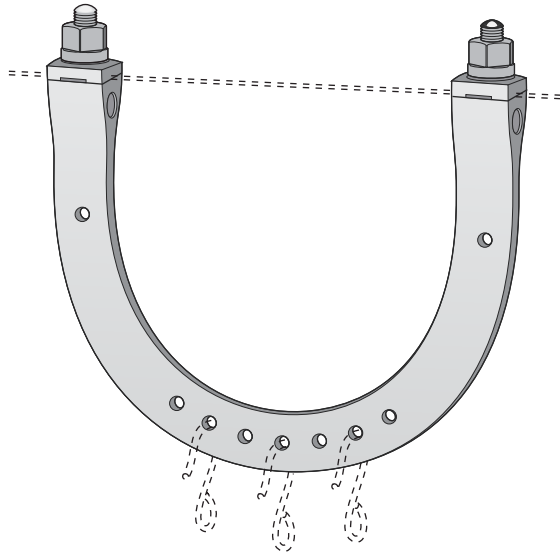

- WIS-LS-370** 200 x 155 mm
- WIS-LS-371** 155 x 155 mm
- WIS-LS-372** 155 x 100 mm
- WIS-LS-373** 135 x 130 mm
- WIS-LS-374** 120 x 120 mm
- WIS-LS-375** 105 x 100 mm
- WIS-LS-376** 95 x 110 mm
- WIS-LS-377** 105 x 80 mm
- WIS-LS-378** 95 x 70 mm

KIRSCHNER  
**WIS-LS-370/WIS-LS-378**

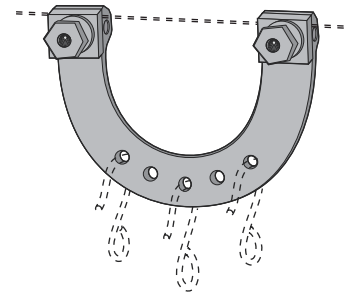

KIRSCHNER  
**WIS-LS-379**  
60 x 50 mm

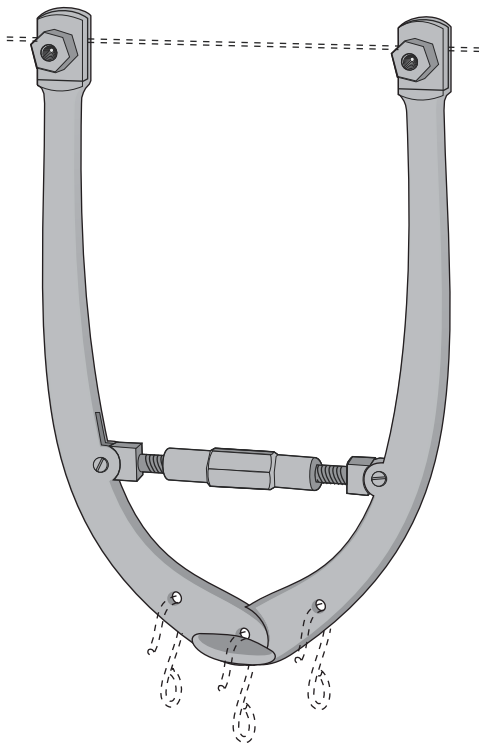

**WIS-LS-380** 180 x 100 mm  
**WIS-LS-381** 270 x 160 mm



**WIS-LS-382**

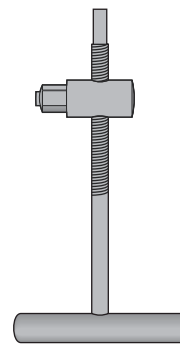

**WIS-LS-383**

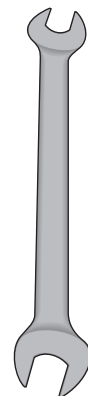

**WIS-LS-384**



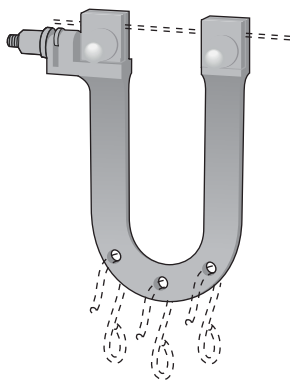

**WIS-LS-385**  
30 x 80 mm

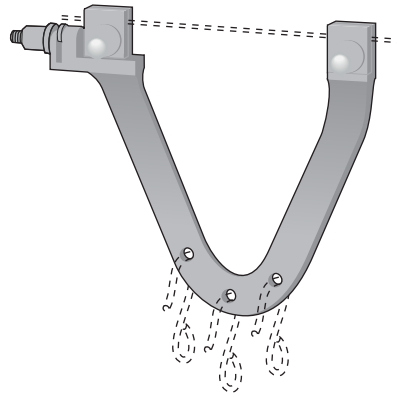

**WIS-LS-386**  
60 x 70 mm

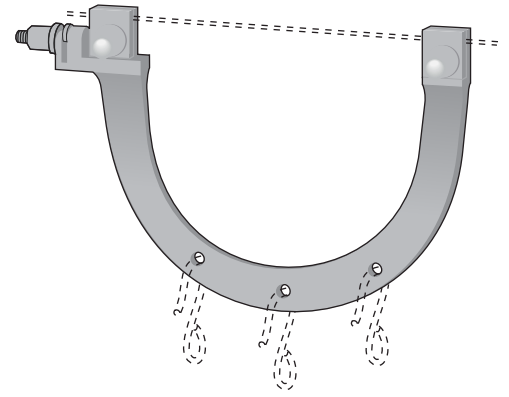

**WIS-LS-387**  
105 x 80 mm

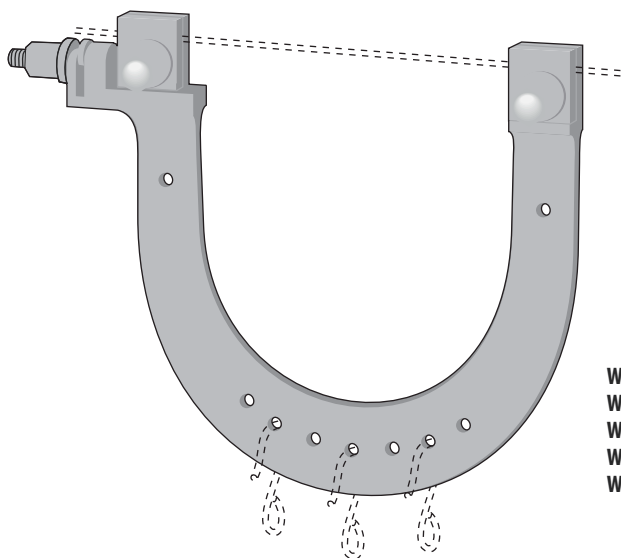

**WIS-LS-390/WIS-LS-394**

- WIS-LS-390** 95 x 155 mm
- WIS-LS-391** 120 x 115 mm
- WIS-LS-392** 135 x 125 mm
- WIS-LS-393** 155 x 140 mm
- WIS-LS-394** 200 x 140 mm

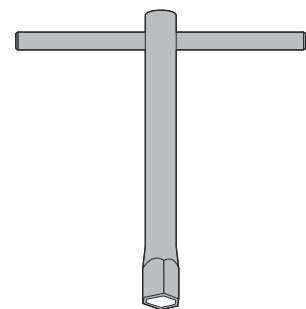

**WIS-LS-388/WIS-LS-389**

Dental schaft  
 Attacco Dentale

∅ 1,5 mm



**WIS-LS-32**  
 50 mm

∅ 2,0 mm



**WIS-LS-33**  
 55 mm

Mit AO schaft  
 Attacco AO

∅ 1,5 mm



**WIS-LS-10**  
 65 mm

∅ 2 mm



**WIS-LS-11**  
 70 mm

∅ 2,7 mm



**WIS-LS-12**  
 100 mm

Passo della vite  
 a 1,25 mm

∅ 3,5 mm



**WIS-LS-13**  
 110 mm

Passo della vite  
 a 1,75 mm

∅ 3,5 mm



**WIS-LS-14**  
 110 mm

∅ 4,5 mm



**WIS-LS-15**  
 130 mm

∅ 4,5 mm



**WIS-LS-16**  
 130 mm

∅ 6,5 mm



**WIS-LS-17**  
 170 mm

Mit AO schaft  
Drill bits  
Attacco AO

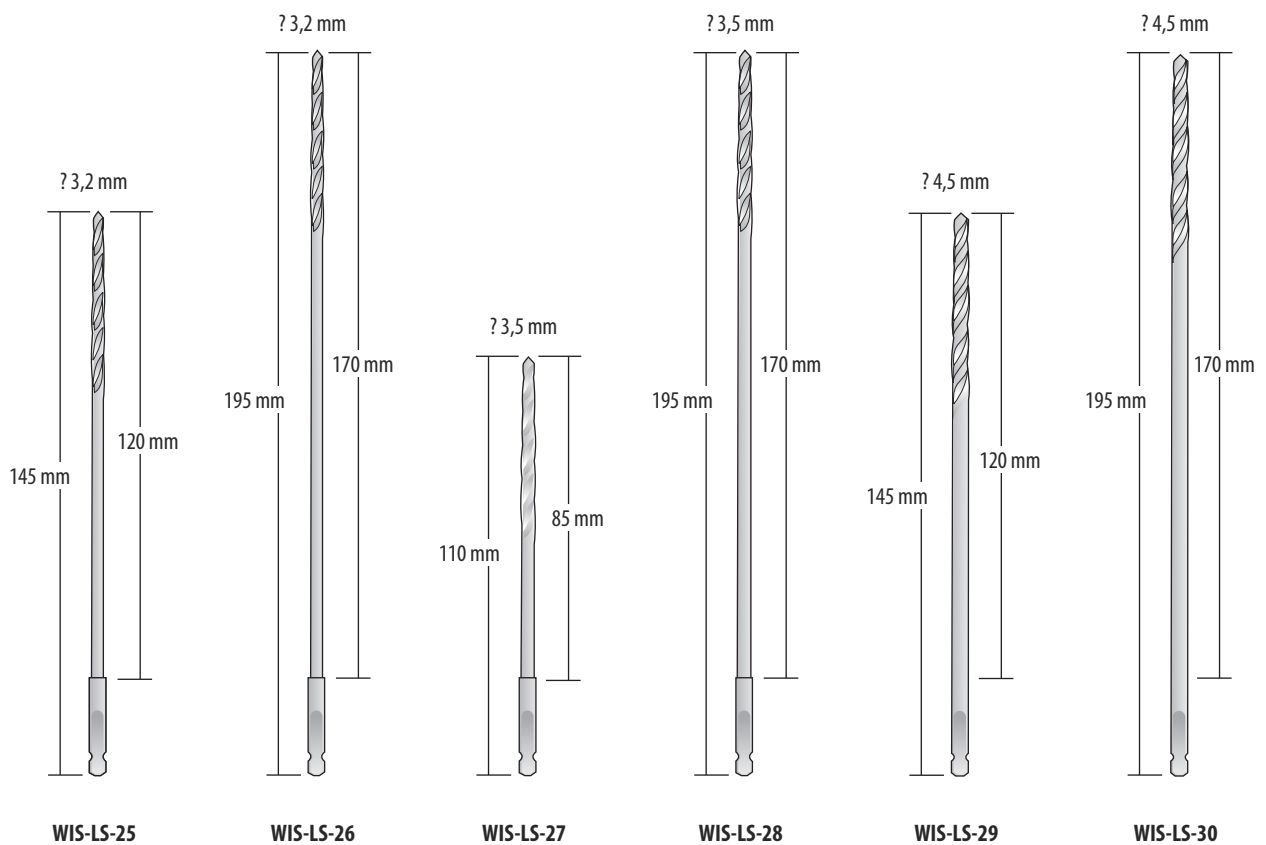
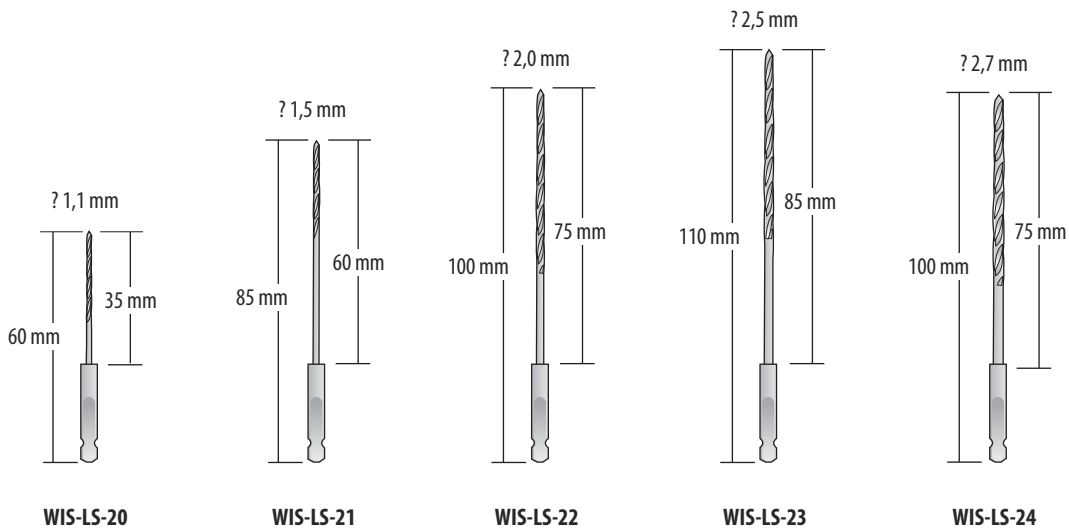

Mit rundschaft  
Drill bits  
Con attacco rotondo

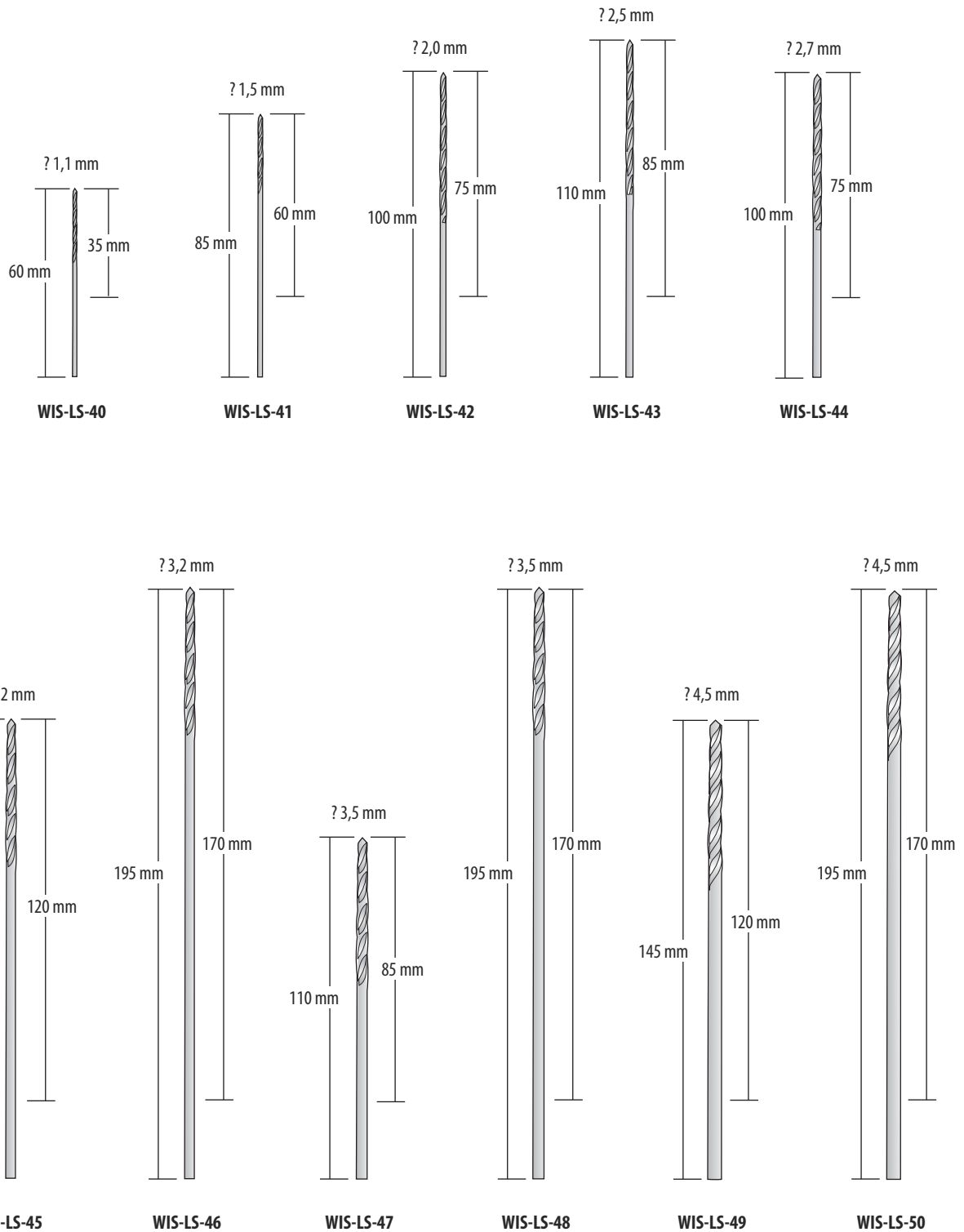

Mit rundschaft  
Drill bits  
Con attacco rotondo

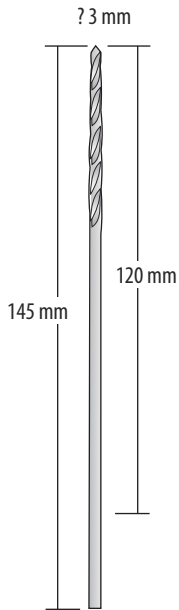

**WIS-LS-51**

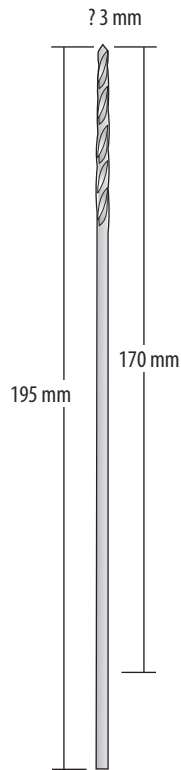

**WIS-LS-52**

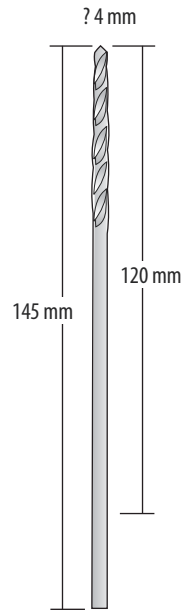

**WIS-LS-53**

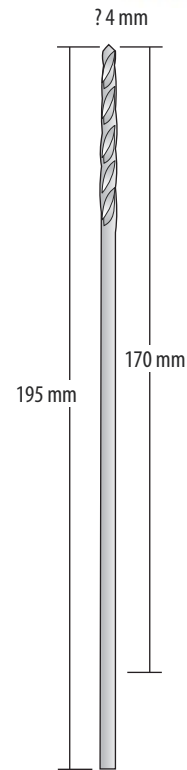

**WIS-LS-54**

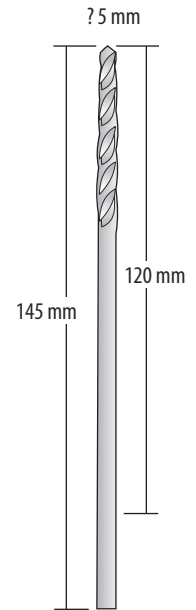

**WIS-LS-55**

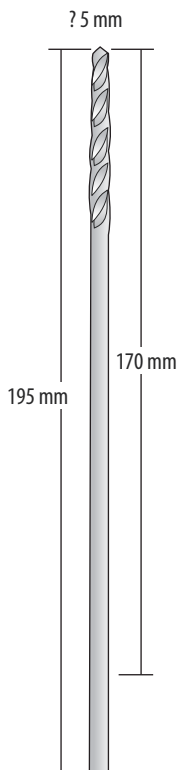

**WIS-LS-56**

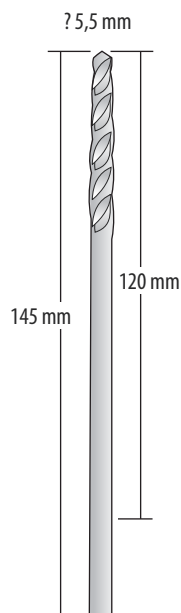

**WIS-LS-57**

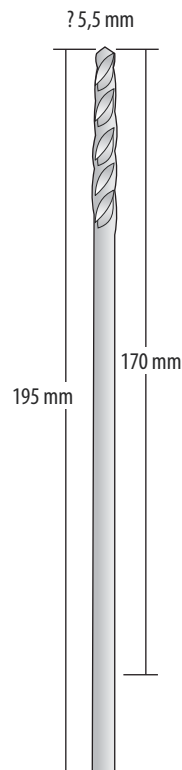

**WIS-LS-58**

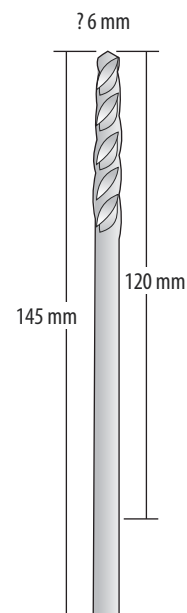

**WIS-LS-59**

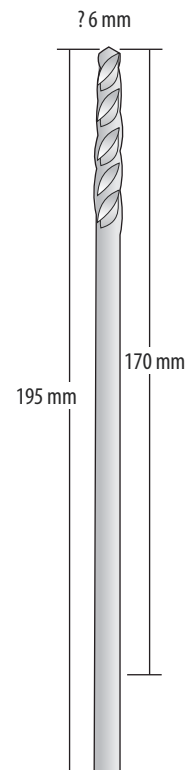

**WIS-LS-60**

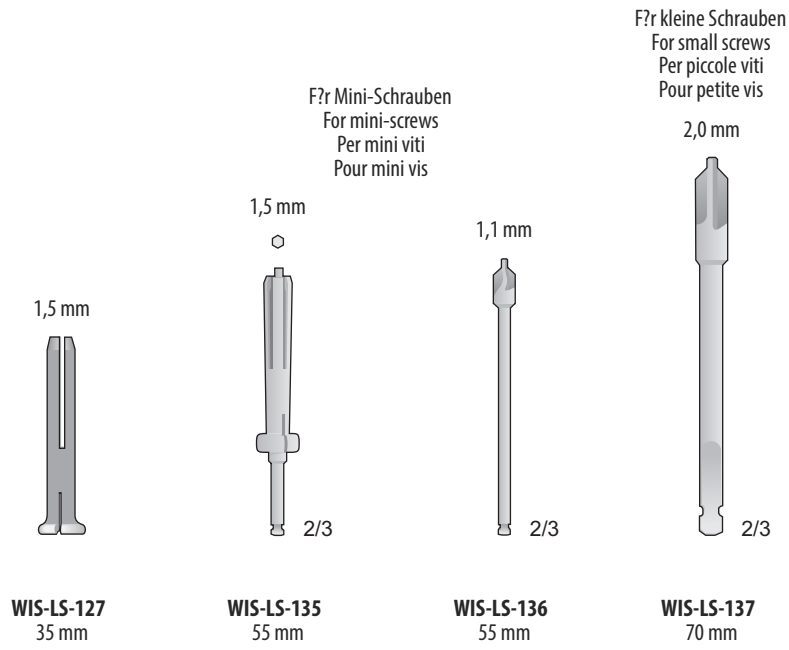

Für Malleolarschrauben  
For malleolar screws  
Per viti malleolari  
Pour vis ? mall?ole

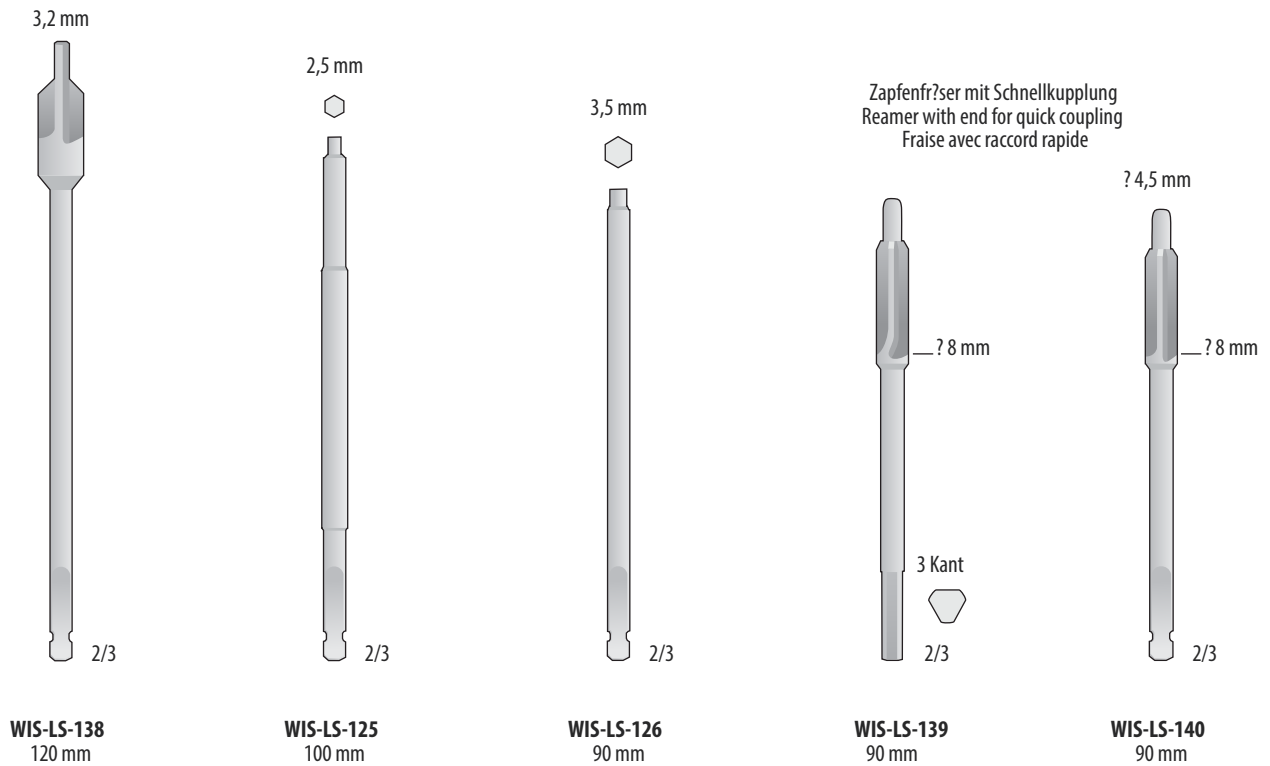

Handgriffe mit schnellspann futter  
 Handles with quick-action chuck  
 Manico con mandrino rapido  
 Poignees avec mandrins rapides

ø 4 mm

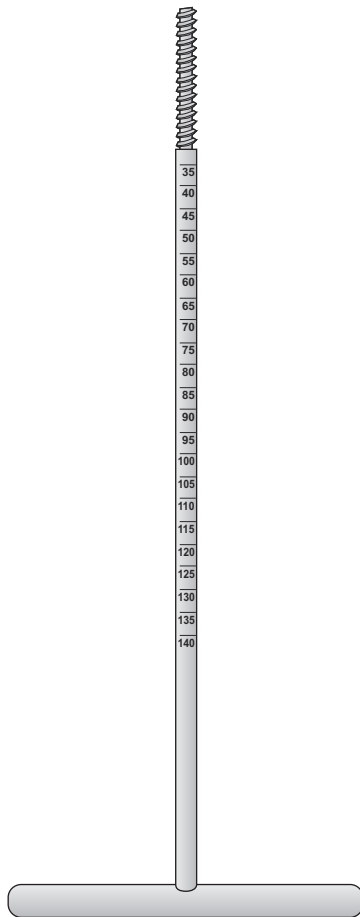

**WIS-LS-120**  
260 mm

AO-Schaft



MANICO FERROZELL  
**WIS-LS-242**  
125 mm

Dental-Schaft

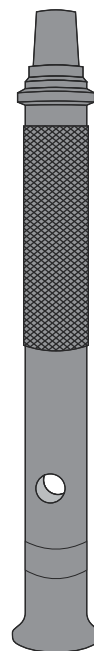

**WIS-LS-244**  
110 mm

4kant-Schaft

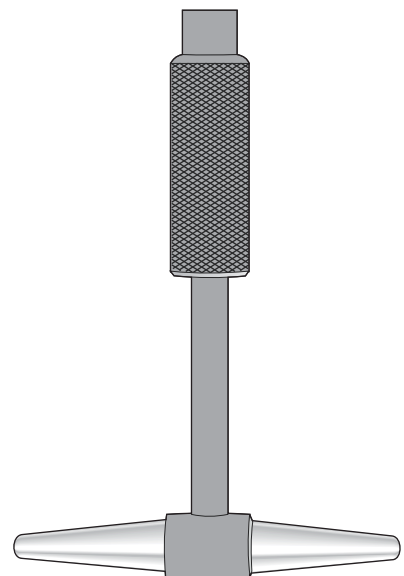

**WIS-LS-240**  
80 mm

**WIS-LS-233**  
Komplett mit - Complete with  
Completo con - Completos con  
Completos avec:  
**WIS-LS-236**  
**WIS-LS-229**  
**WIS-LS-241**

Attacco A0

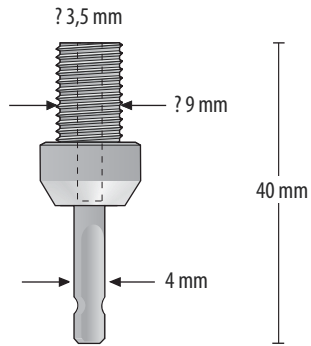

**WIS-LS-227**  
40 mm

Inox  
ORIGINAL JACOBS

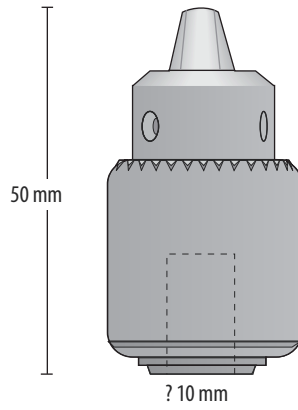

**WIS-LS-236**  
50 mm

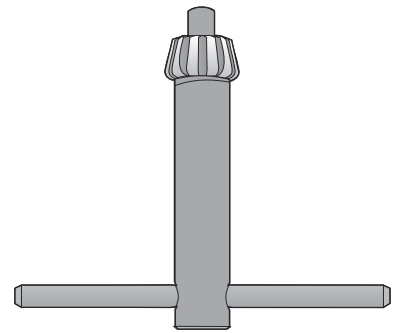

**WIS-LS-241**  
52 mm

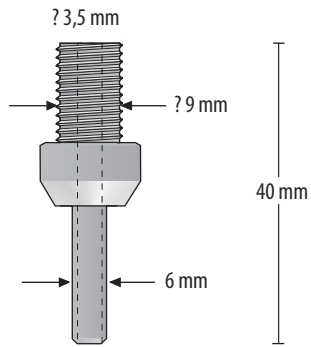

**WIS-LS-228**  
40 mm

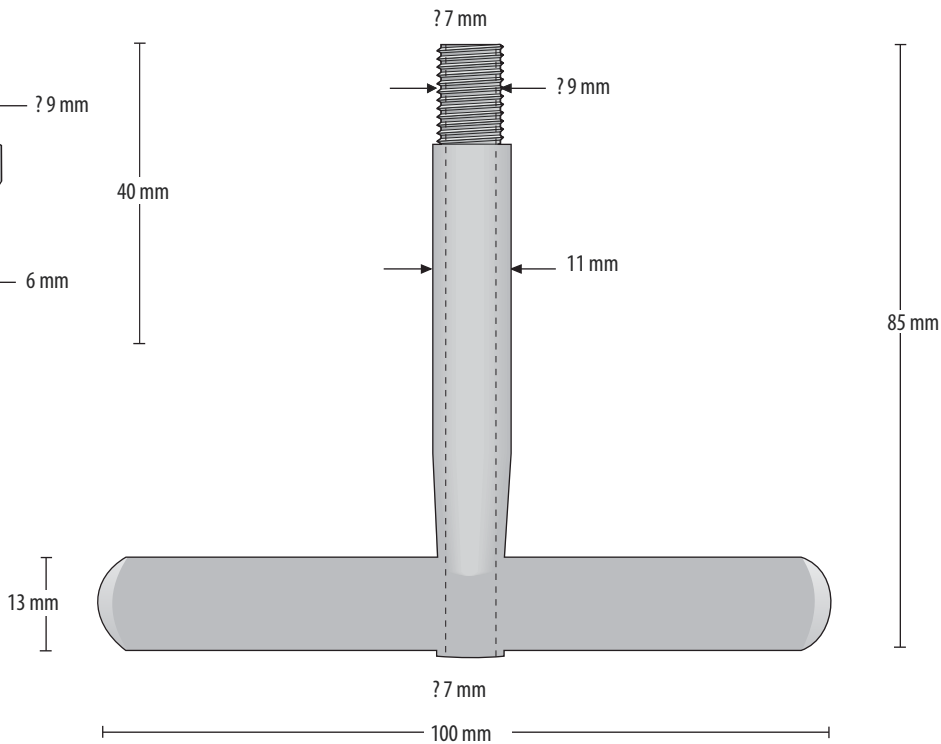

**WIS-LS-229**  
85 mm



**WIS-LS-239**  
Komplett mit - Complete with  
Completo con - Completos con  
Completos avec:  
**WIS-LS-236**  
**WIS-LS-237**  
**WIS-LS-238**  
**WIS-LS-241**

Inox  
ORIGINAL JACOBS

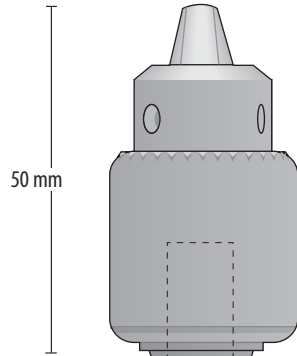

10 mm  
**WIS-LS-236**  
50 mm

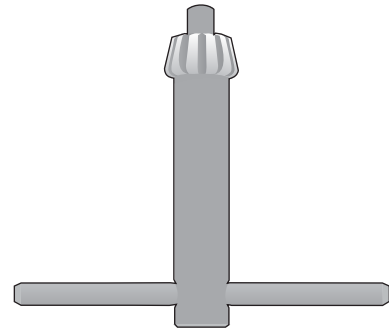

**WIS-LS-241**  
52 mm

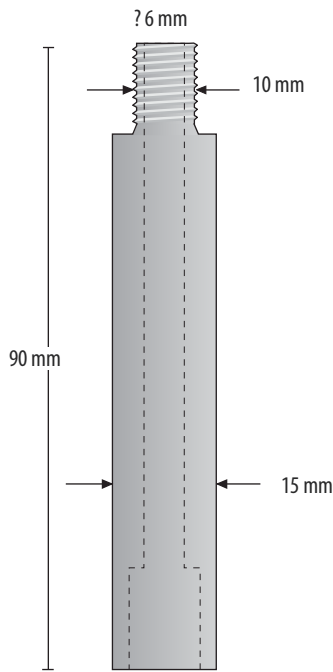

10 mm  
**WIS-LS-237**  
90 mm

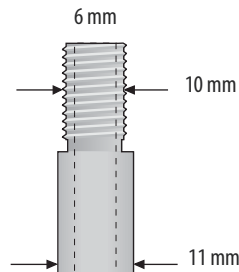

**WIS-LS-238**  
130 mm

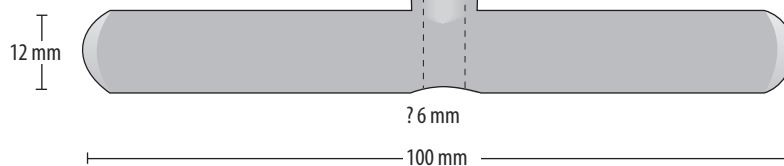



Von Handt zu spann  
Tightened by hand  
Con chiusura a mano

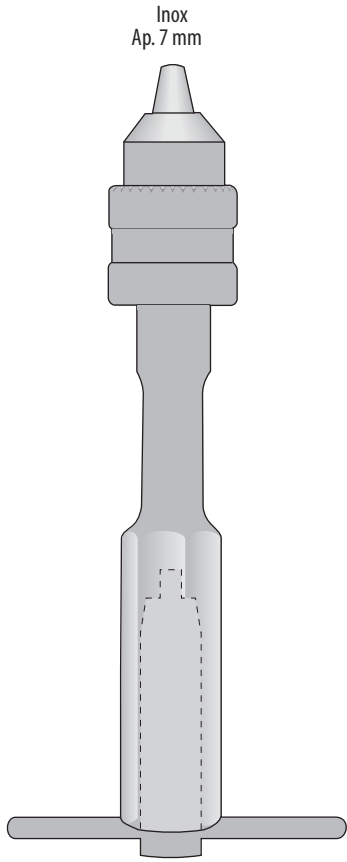

**WIS-LS-232**  
130 mm

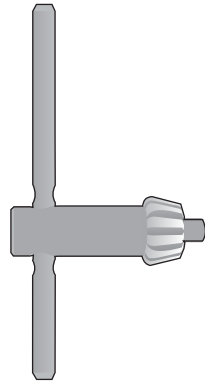

**WIS-LS-231**  
32 mm

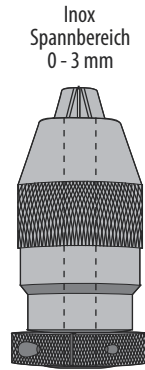

**WIS-LS-222**

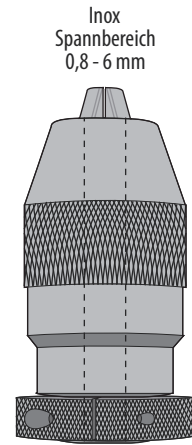

**WIS-LS-224**

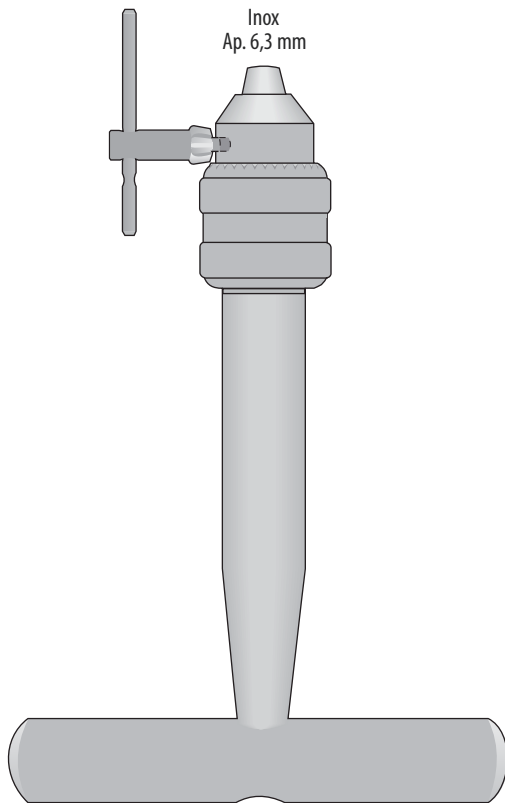

**WIS-LS-230**  
130 mm

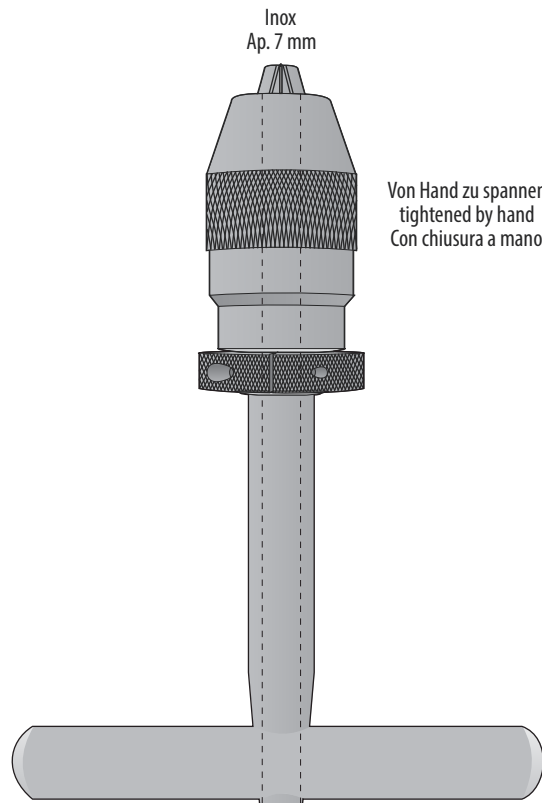

**WIS-LS-234**  
135 mm



**WIS-FR-20**  
**WIS-FR-21+WIS-FR-22+WIS-FR-23**  
**WIS-FR-24+WIS-FR-25+WIS-FR-26**  
 Komplet, mit Fräsern Fig. 1-4 und Verlängerungsstück  
 Complete, with burrs no. 1-4 and extension piece  
 Completo, con fresa Fig. 1-4 e giunto di prolungamento  
 Completo, con fresas no. 1-4 y pieza de prolongación  
 Complet, avec fraises no. 1-4 et pièce de rallonge

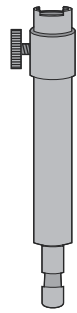

Verlängerungsstück  
 Extension Piece  
 Giunto di prolungamento  
 Pieza de prolongación  
 Pièce de rallonge

HUDSON  
**WIS-FR-22**

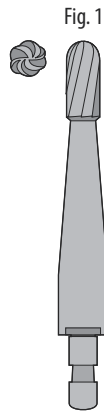

Fig. 1

HUDSON  
**WIS-FR-23**  
 9 mm

Kegelfräser  
 Conical Burr  
 Fresa cuneiforme  
 Fresa cónica  
 Fraise conique



Fig. 2

HUDSON  
**WIS-FR-24**  
 14 mm

Kegelfräser  
 Conical Burr  
 Fresa cuneiforme  
 Fresa cónica  
 Fraise conique

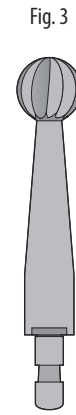

Fig. 3

HUDSON  
**WIS-FR-25**  
 16 mm

Kugelfräser  
 Spherical Burr  
 Fresa sferica  
 Fresa esférica  
 Fraise sphérique

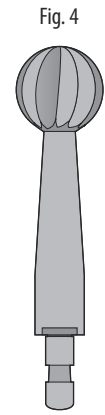
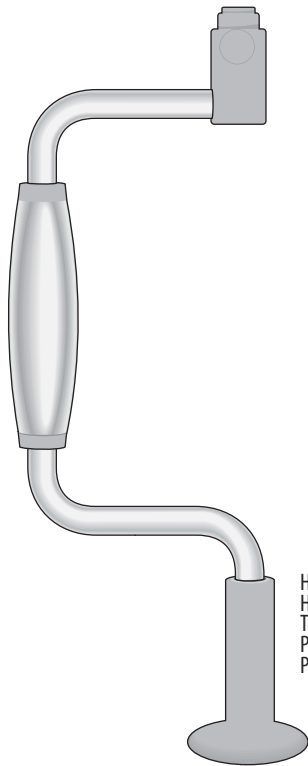

Fig. 4

HUDSON  
**WIS-FR-26**  
 22 mm

Kugelfräser  
 Spherical Burr  
 Fresa sferica  
 Fresa esférica  
 Fraise sphérique



Handbohrer allein  
 Hand drill only  
 Trapano solo  
 Perforador suelto  
 Perforateur seul

HUDSON  
**WIS-FR-21**  
 280 mm

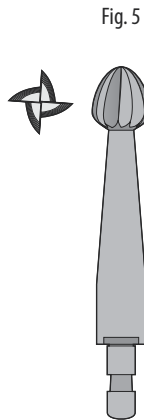

Fig. 5

ADSON  
**WIS-FR-27**  
 15 mm

Bohrer  
 Burr  
 Punta  
 Fresa  
 Fraise



Fig. 6

Mc KENZIE  
**WIS-FR-28**  
 13 mm

Bohrer  
 Burr  
 Punta  
 Fresa  
 Fraise



Fig. 7

CUSHING  
**WIS-FR-29**  
 14 mm

Flachbohrer  
 Flat Trephine  
 Trapano piatto  
 Taladro plano  
 Fraise plate



Fig. 8

**WIS-FR-30**  
 2 mm

Spiralbohrer  
 Twist Drill  
 Punta a spirale  
 Broca espiral  
 Mèche hélicoïdale

Schraubendreher  
Pfieme

Screwdrivers  
Awls

Cacciaviti  
Punteruolo

Destornilladores  
Lezna

Tournevis  
Alêne

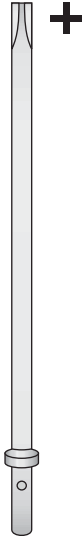

**WIS-LS-321**  
140 mm



**WIS-LS-322**  
140 mm

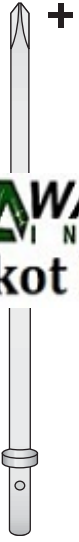

**WIS-LS-323**  
140 mm



**WIS-LS-324**  
140 mm

2,5 mm

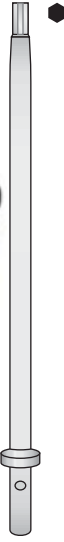

**WIS-LS-325**  
140 mm

3,5 mm

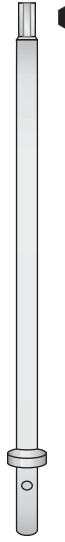

**WIS-LS-326**  
140 mm

**WAAORTHO**  
INDUSTRY  
**Sialkot Pakistan**

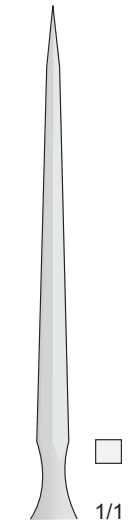
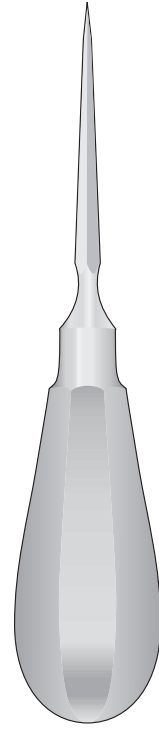

**WIS-TR-77**  
140 mm

**WIS-LS-330**  
(WIS-LS-321 + WIS-LS-322 + WIS-LS-323 + WIS-LS-324 + WIS-LS-325 + WIS-LS-326 + WIS-LS-329)  
Schraubenzieher, Set mit Etui / Box with screws driver / Scatola con set giraviti  
Set de destornilladores / Bo?te de jeu de tournevis

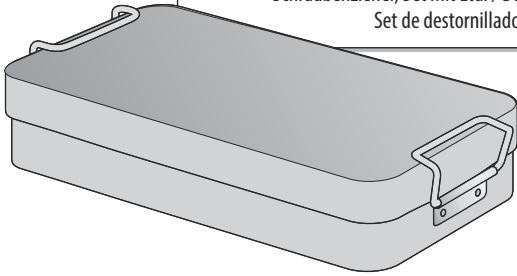

**WIS-LS-329**  
200x100x40 mm  
Etui allein / Box only / Solo scatola  
bo?te / Seul ola Caja

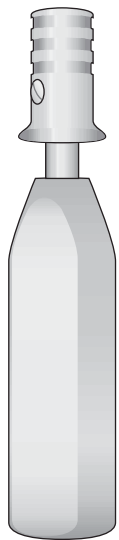

**WIS-LS-320**  
145 mm

Max. 6,3 mm

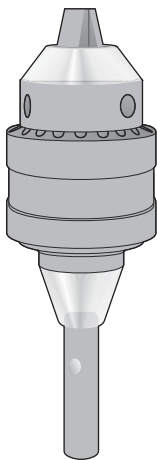

UNIVERSAL  
**WIS-LS-235**  
75 mm

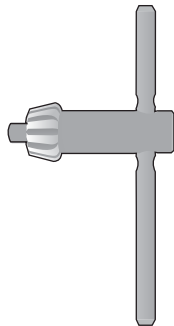

**WIS-LS-231**  
32 mm

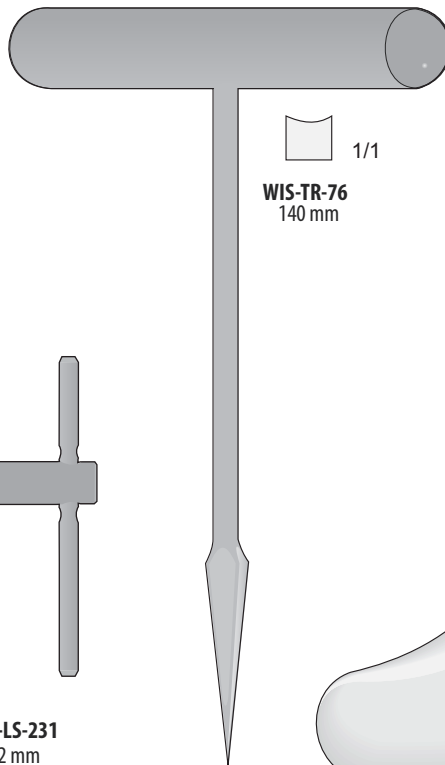

**WIS-TR-76**  
140 mm

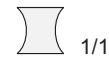

PERTHES  
**WIS-TR-78**  
210 mm

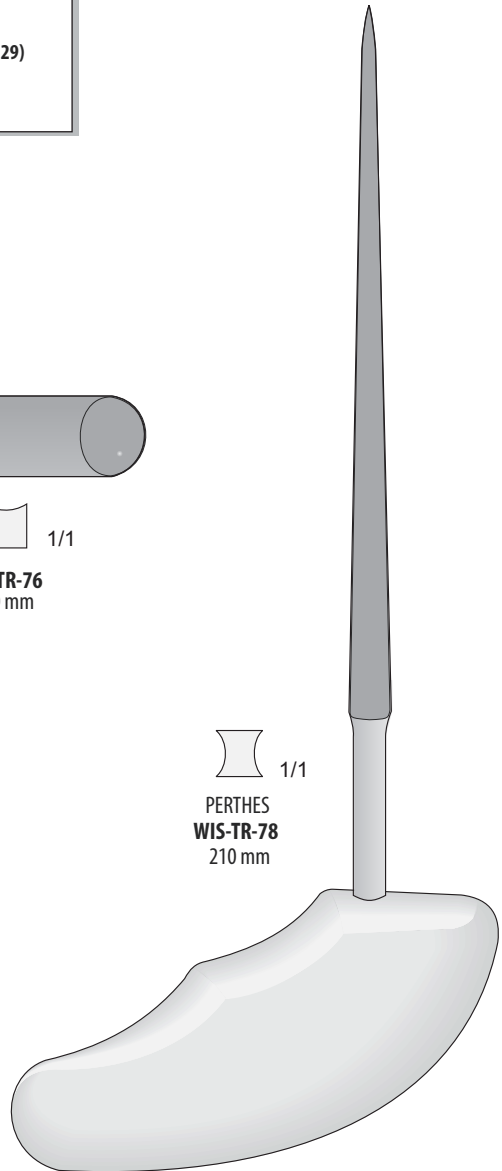

Schraubenzieher mit Ferrozellgri?  
Screws driver with Ferrozell handle  
Giraviti con manico di Ferrozell  
Destornilladores con mango de Ferrozell  
Jeu de tournevis avec poign?e en Ferrozell

Schraubenzieher mit Ferrozellgri?  
Screws driver with Ferrozell handle  
Giraviti con manico di Ferrozell  
Destornilladores con mango de Ferrozell  
Jeu de tournevis avec poign?e en Ferrozell

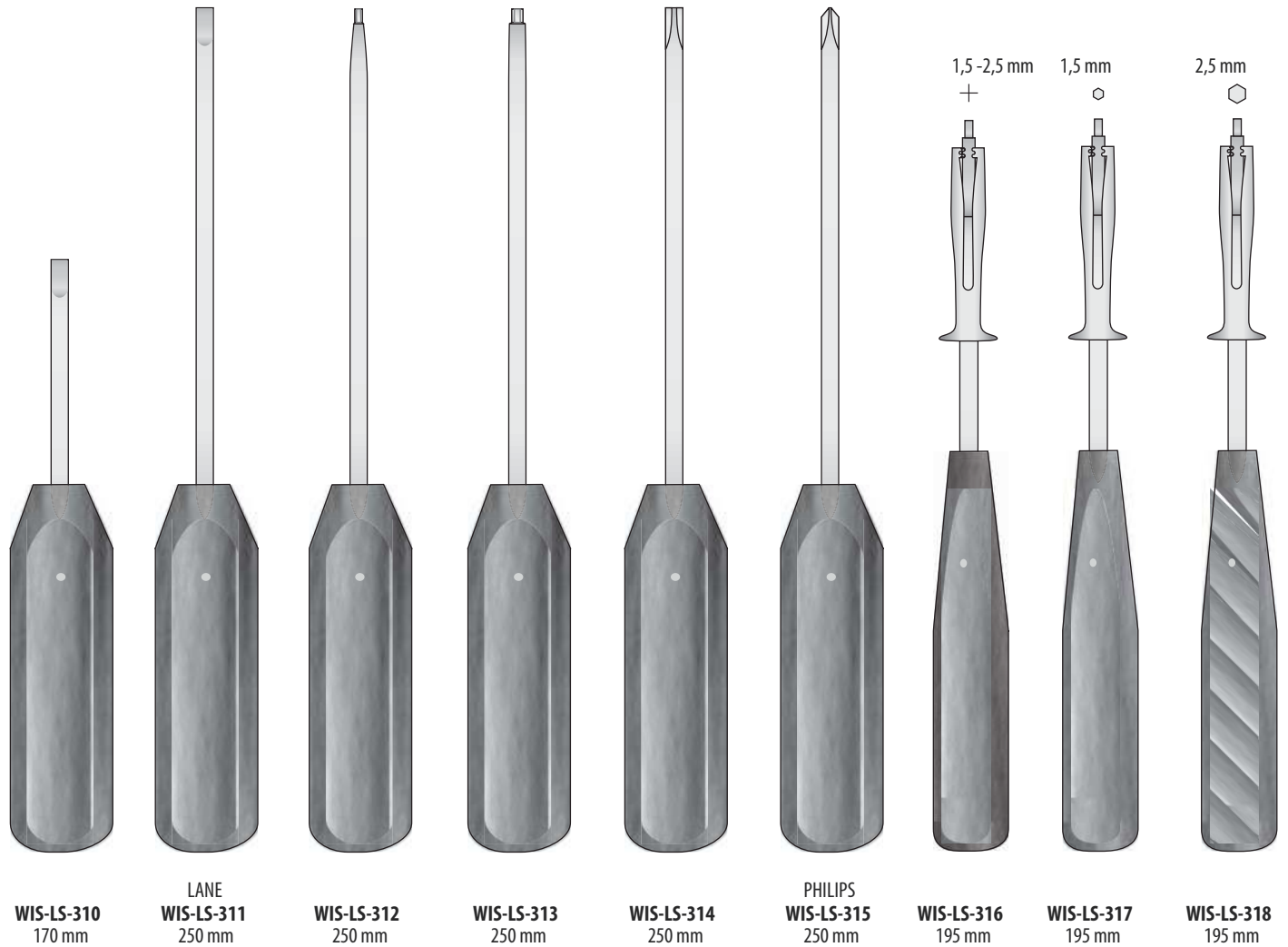
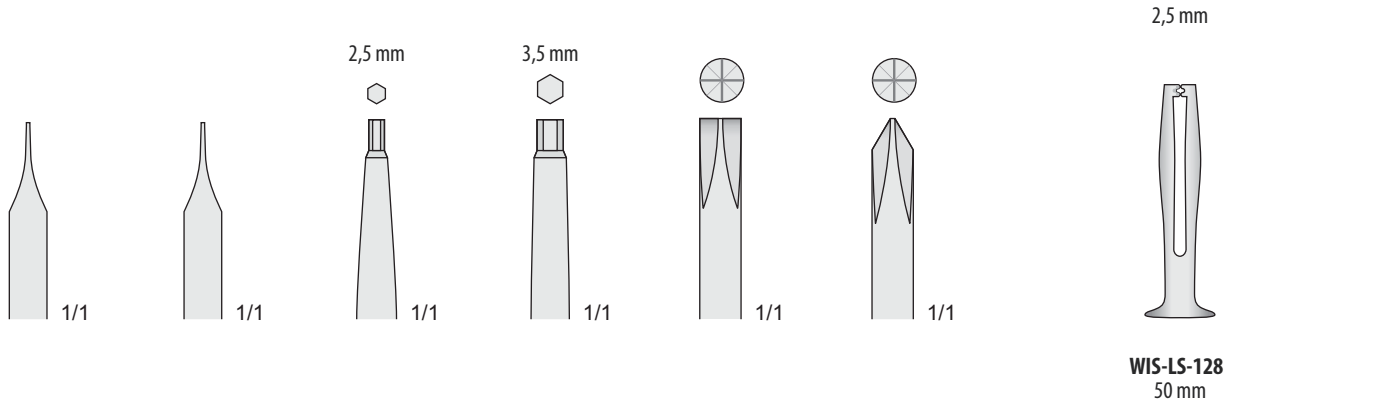

Drahtinstrumentarium  
Wire instrument set  
Strumenti per filo di cerchiaggio  
Instrumental para cerclaje  
Instruments ? ?l

Draht weich  
Wire soft  
Filo malleabile  
per compattare l'osso  
Alambre ligadura  
Fil ? os

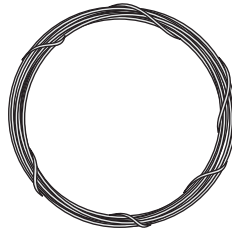

10 mt.

?/Diam.	Codice
0,2 mm	<b>WIS-KI-202</b>
0,3 mm	<b>WIS-KI-203</b>
0,4 mm	<b>WIS-KI-204</b>
0,5 mm	<b>WIS-KI-205</b>
0,6 mm	<b>WIS-KI-206</b>
0,7 mm	<b>WIS-KI-207</b>
0,8 mm	<b>WIS-KI-208</b>
0,9 mm	<b>WIS-KI-209</b>
1,0 mm	<b>WIS-KI-210</b>
1,2 mm	<b>WIS-KI-211</b>
1,5 mm	<b>WIS-KI-212</b>

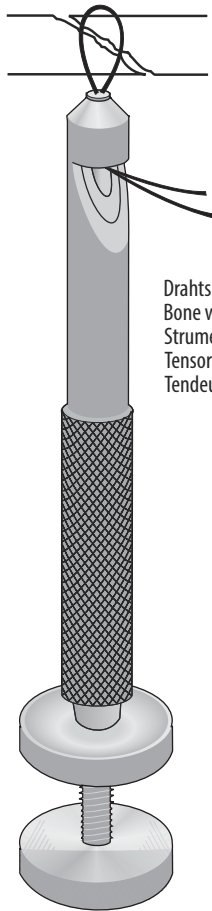

Drahtspanninstrument  
Bone wire tighteners  
Strumenti tendi?li  
Tensor cierra-hilos  
Tendeur serre ?ls

LOUTE  
**WIS-KI-322**  
220 mm

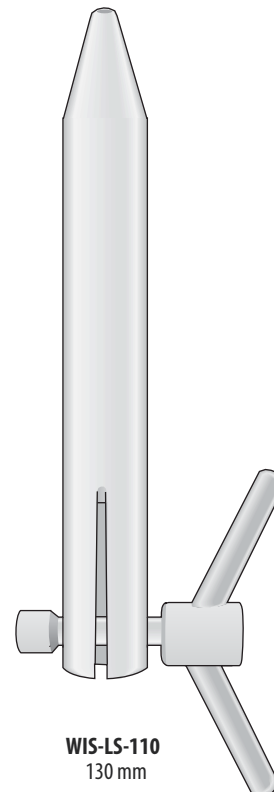

**WIS-LS-110**  
130 mm

Bohrbo?chsen zu Knochenplatten - Drill guides - Centratori guida punte - Guide m?che

**Codi?cazione del colore**

verde = centrico  
oro = eccentrico

Per trapano ? 2,0 mm  
Per viti da corticale ? 2,7 mm

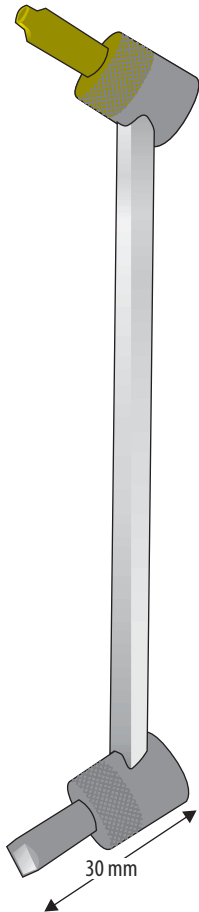

**WIS-LS-91**  
140 mm

Per trapano ? 2,5 mm  
Per viti da corticale ? 3,5 mm

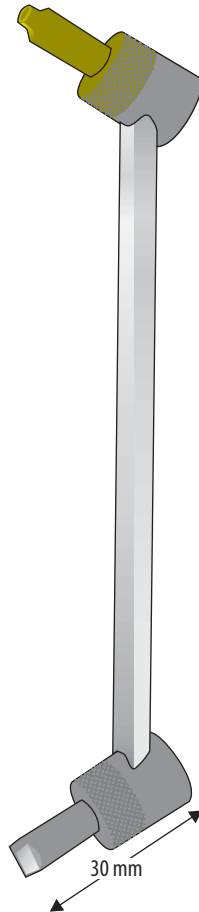

**WIS-LS-90**  
140 mm

Per trapano ? 3,2 mm  
Per viti da corticale ? 4,5 mm

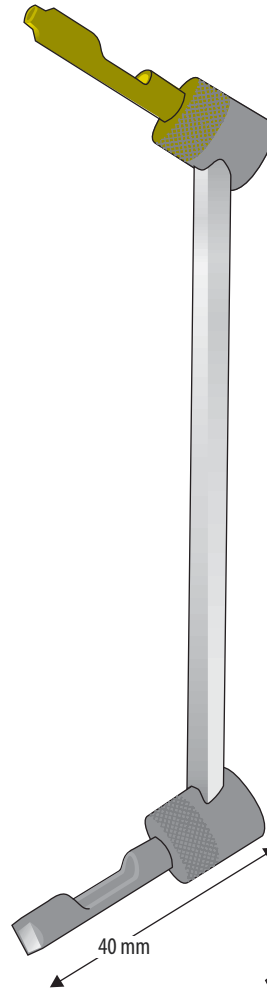

**WIS-LS-92**  
165 mm

Per trapano ? 3,2 mm  
Per viti da corticale ? 4,5 mm

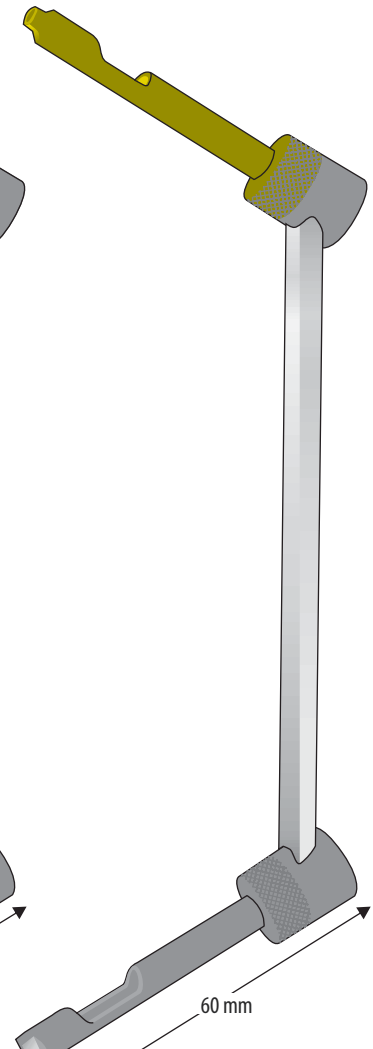

**WIS-LS-93**  
170 mm

Bohrb?chsen zu Knochenplatten - Drill guides - Centrori guida punte - Guide m?che

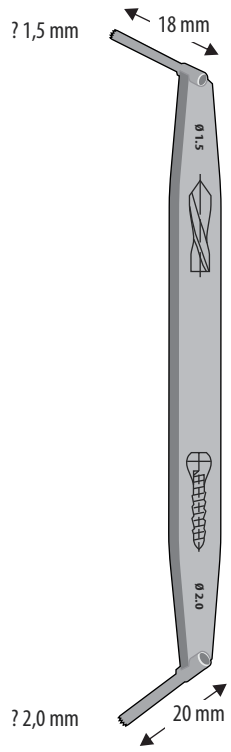

WIS-LS-73  
120 mm

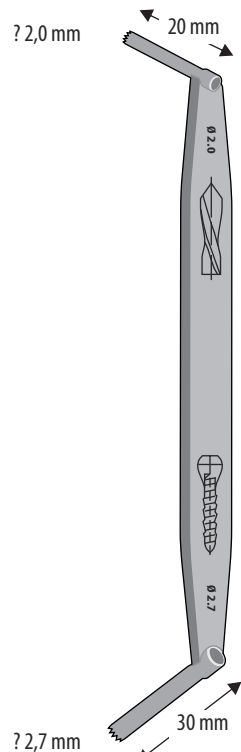

WIS-LS-74  
120 mm

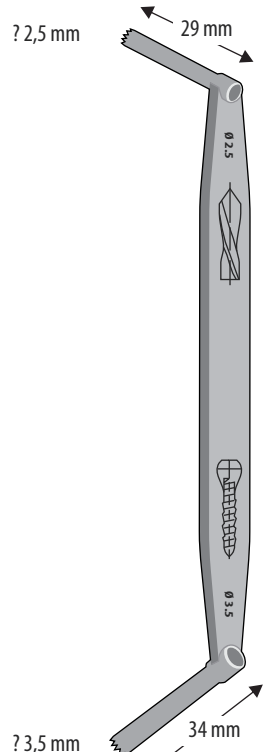

WIS-LS-75  
120 mm

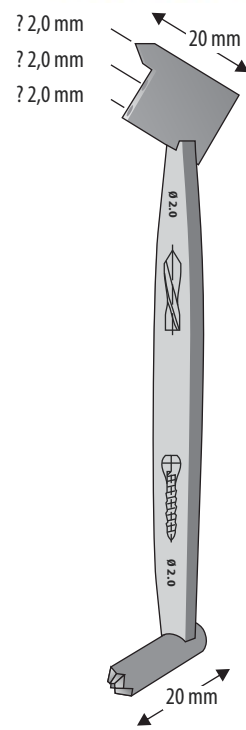

WIS-LS-80  
110 mm

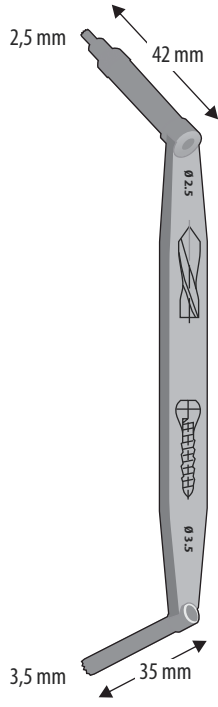

WIS-LS-81

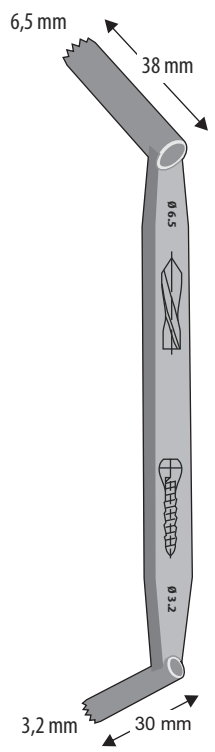

WIS-LS-82

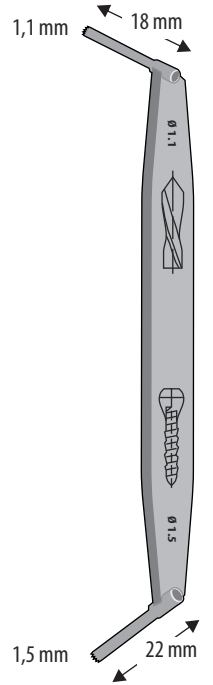

WIS-LS-83  
105 mm

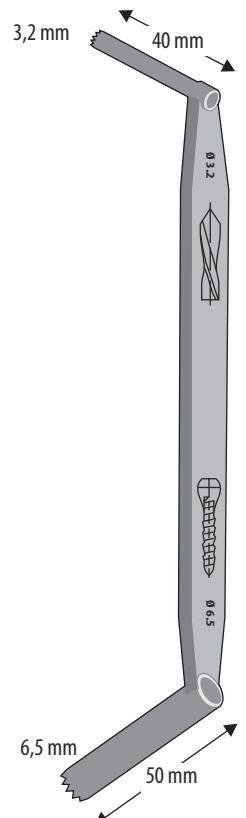

WIS-LS-84  
160 mm

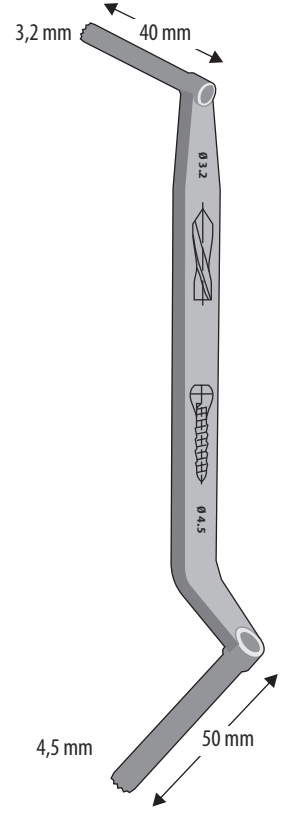

WIS-LS-85



Bohrb?chsen zu Knochenplatten - Drill guides - Centrori guida punte - Guide m?che

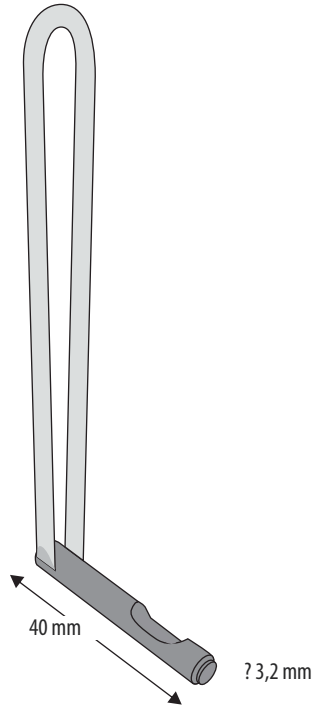

**WIS-LS-117**  
125 mm

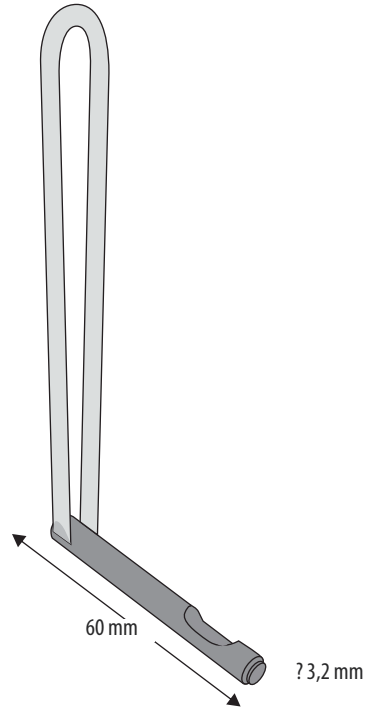

**WIS-LS-124**  
125 mm

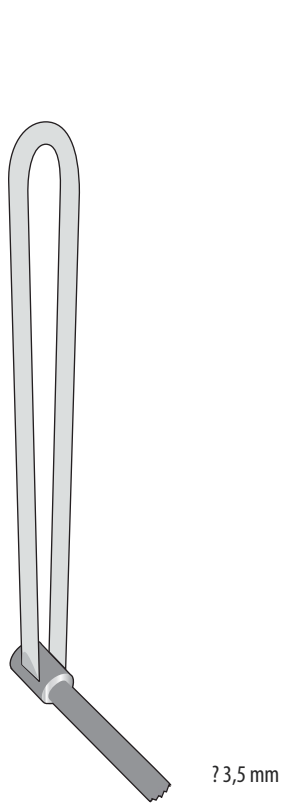

**WIS-LS-116**  
125 mm

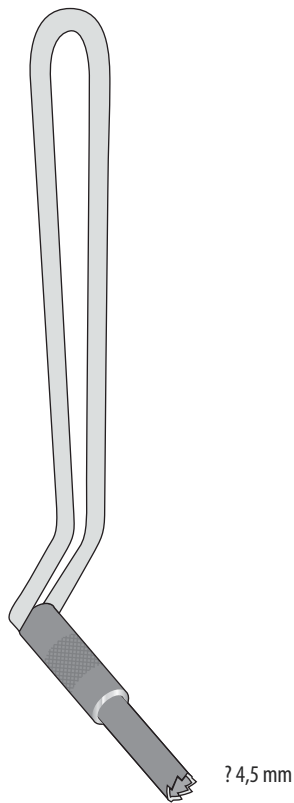

**WIS-LS-119**  
150 mm

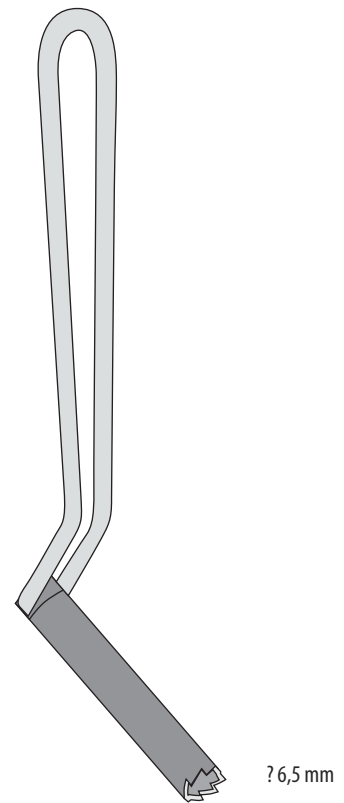

**WIS-LS-121**  
150 mm

**WAA AORTH O**  
INDUSTRY  
**Sialkot Pakistan**

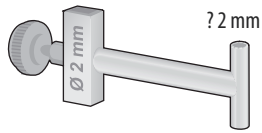

**WIS-LS-96**

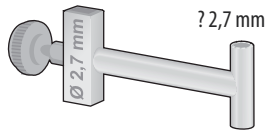

**WIS-LS-97**

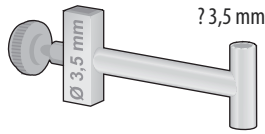

**WIS-LS-98**

Steckbohrb?chsen  
Manicotto dentato  
Centrapunte  
Insert-drill

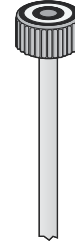

? Au?en  
? Outside  
? Esterno  
? Exterior  
? Ext?rieur

? F?r B ohrer  
? For drills  
? Per punte  
? Para agujas  
? Pour M?ches

Cod. Art.			
<b>WIS-LS-113</b>	4,5 mm	3,2 mm	
<b>WIS-LS-114</b>	3,5 mm	2 mm	
<b>WIS-LS-115</b>	3,5 mm	2,7 mm	

Gewebeschutzh?lsen  
Guida per punte elicoidali

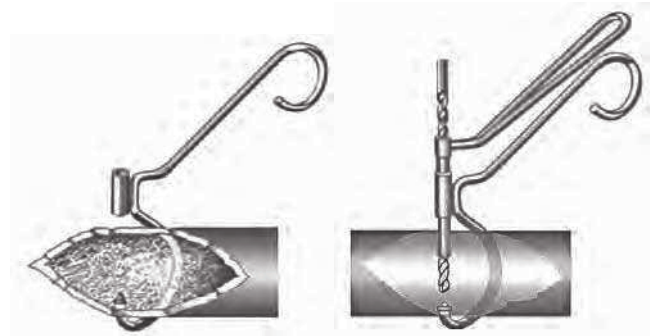

**WIS-LS-95**  
Complete with 3 guide  
Completo di 3 guide  
WIS-LS-94+WIS-LS-96+WIS-LS-97+WIS-LS-98

**WIS-LS-94**  
Drill guide only  
Centratore solo

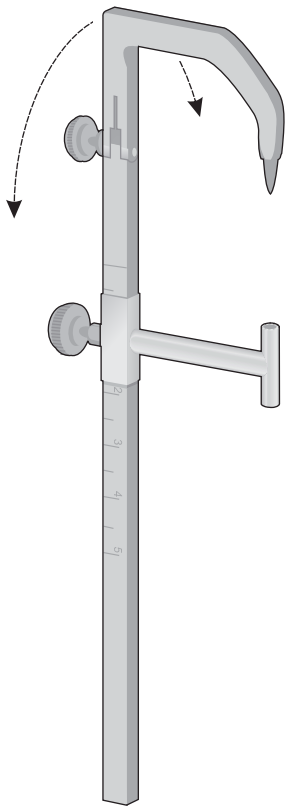

**WIS-LS-95**  
145 mm

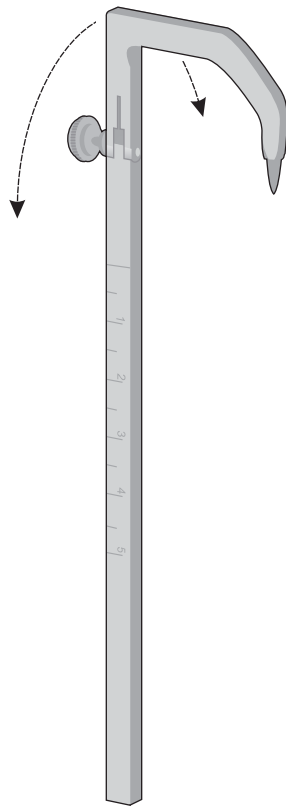

**WIS-LS-94**  
145 mm

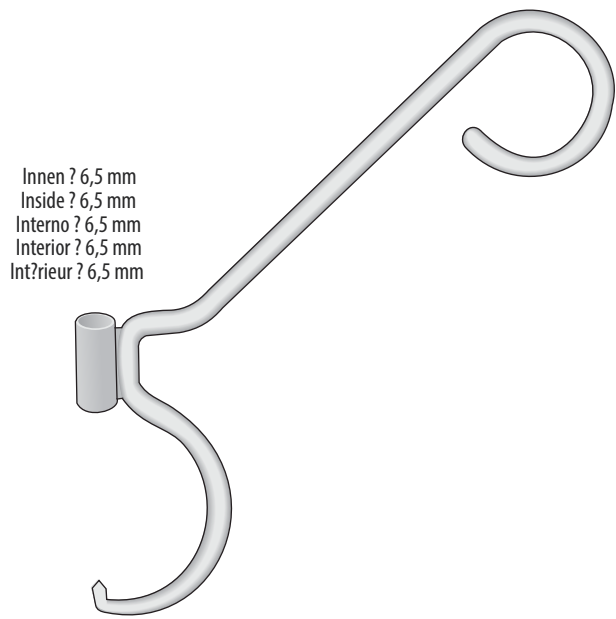

Innen ? 6,5 mm  
Inside ? 6,5 mm  
Interno ? 6,5 mm  
Interior ? 6,5 mm  
Int?rieur ? 6,5 mm

**WIS-LS-112**

**Measuring Instruments**  
Messinstrumente  
Instruments à mesurer  
Instrumentos de medición  
Strumenti per misura



Screw depth gauges, to select proper length of screw  
 Misuratore di lunghezza per viti  
 Instruments ? mesurer dlà longueur de vis  
 Instrumento para medir el largo del tornillo



**WIS-KI-10**  
 Meßlehre für Kirschnerdrähte  
 Measuring Gauge for K-wire  
 Misuratore per chiodi Kirschner  
 Medidor para agujas Kirschner

? 1,0 mm

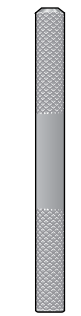

Skala  
 Scala  
 0?30 mm

**WIS-LS-199**  
 138 mm

? 1,6 mm

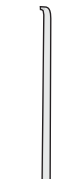

Skala  
 Scala  
 0?50 mm

**WIS-LS-200**  
 156 mm

? 1,6 mm

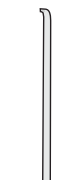

Skala  
 Scala  
 0?70 mm

**WIS-LS-201**  
 190 mm

? 1,6 mm



Skala  
 Scala  
 0?120 mm

**WIS-LS-202**  
 285 mm

1/1

0,5 mm



**WIS-LS-07**  
 50 mm

0,5 mm



**WIS-LS-08**  
 100 mm

0,5 mm

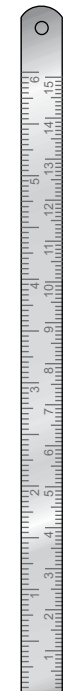

**WIS-LS-09**  
 150 mm

0,5 mm



**WIS-LS-06**  
 300 mm

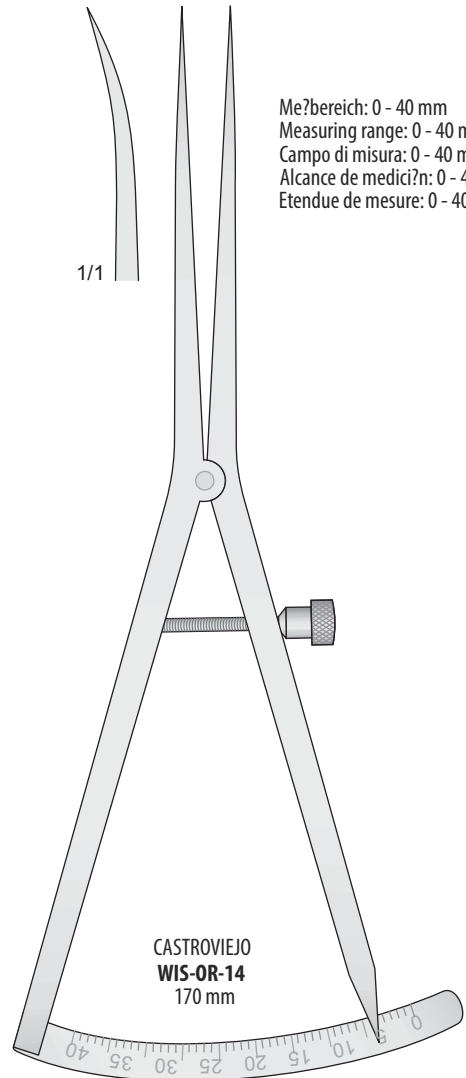
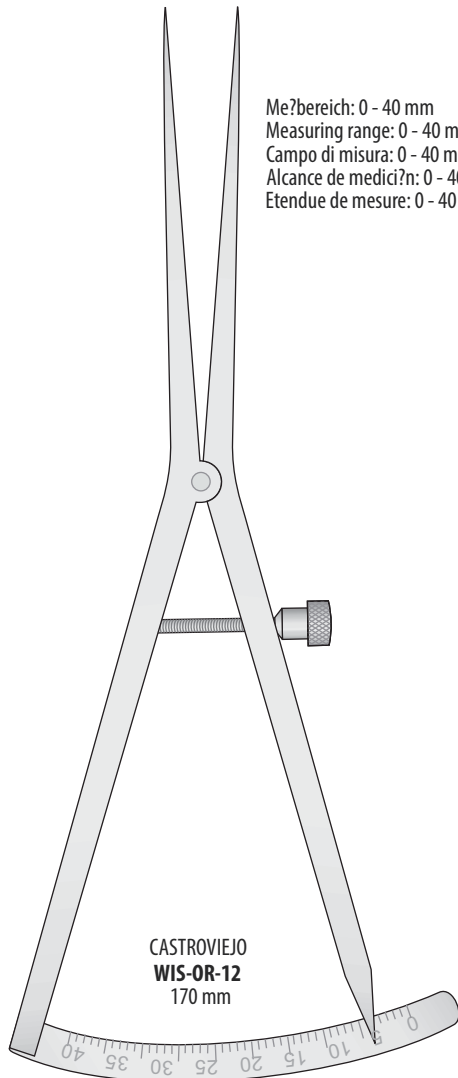

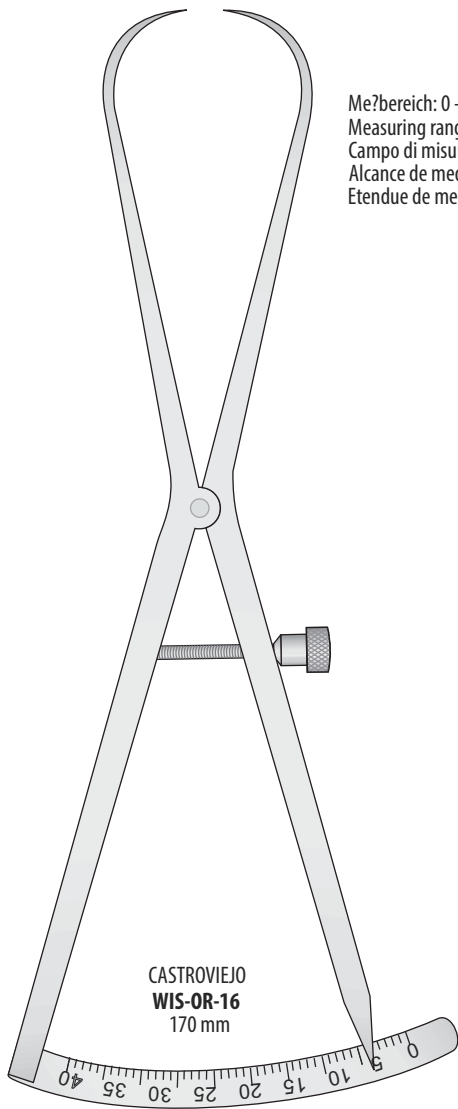

Meßbereich: 0 - 40 mm  
 Measuring range: 0 - 40 mm  
 Campo di misura: 0 - 40 mm  
 Alcance de medición: 0 - 40 mm  
 Etendue de mesure: 0 - 40 mm

CASTROVIEJO  
**WIS-OR-16**  
 170 mm

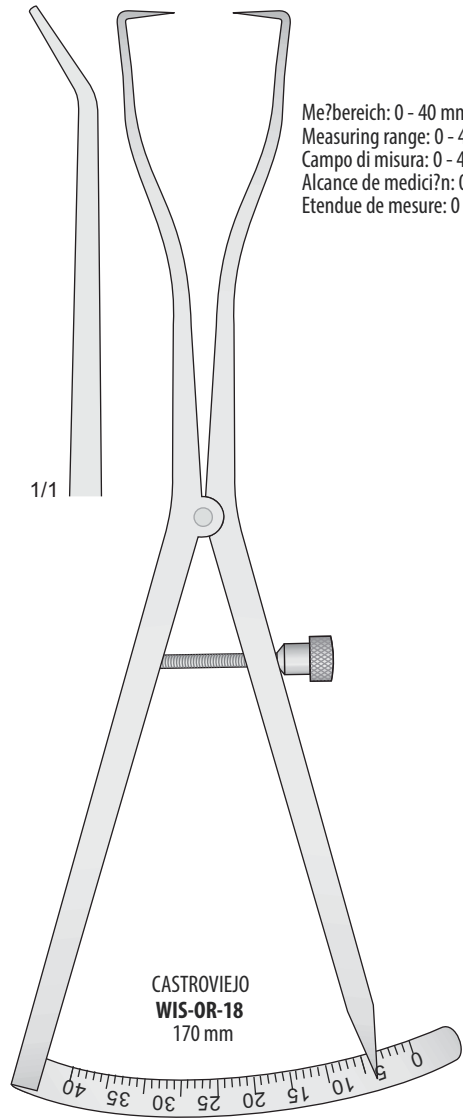

Meßbereich: 0 - 40 mm  
 Measuring range: 0 - 40 mm  
 Campo di misura: 0 - 40 mm  
 Alcance de medición: 0 - 40 mm  
 Etendue de mesure: 0 - 40 mm

1/1

CASTROVIEJO  
**WIS-OR-18**  
 170 mm

Meßbereich: 0 - 40 mm  
Measuring range: 0 - 40 mm  
Campo di misura: 0 - 40 mm  
Alcance de medición: 0 - 40 mm  
Etendue de mesure: 0 - 40 mm

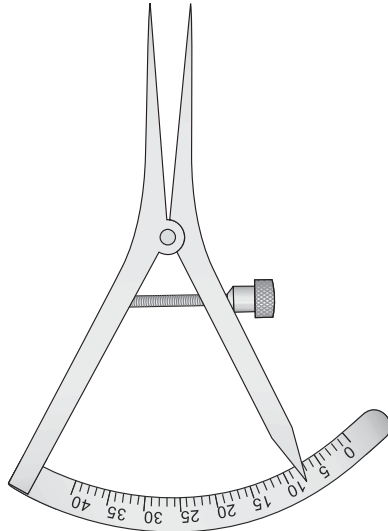

**CASTROVIEJO**  
**WIS-OR-11**  
90 mm

Meßbereich: 0 - 40 mm  
Measuring range: 0 - 40 mm  
Campo di misura: 0 - 40 mm  
Alcance de medición: 0 - 40 mm  
Etendue de mesure: 0 - 40 mm

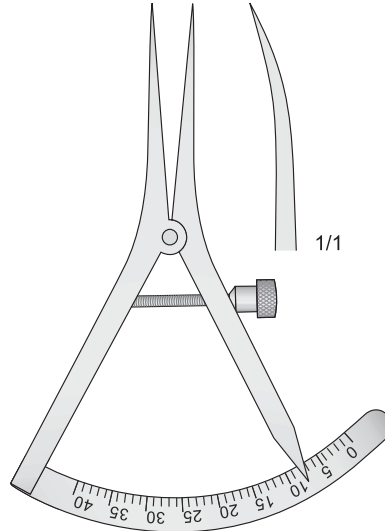

**CASTROVIEJO**  
**WIS-OR-13**  
90 mm

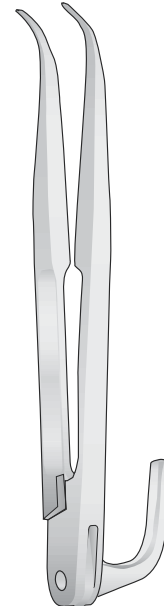

**ZIENLINSKY**  
**WIS-DP-725**  
100 mm

Meßbereich: 0 - 15 mm  
Measuring range: 0 - 15 mm  
Campo di misura: 0 - 15 mm  
Alcance de medición: 0 - 15 mm  
Etendue de mesure: 0 - 15 mm

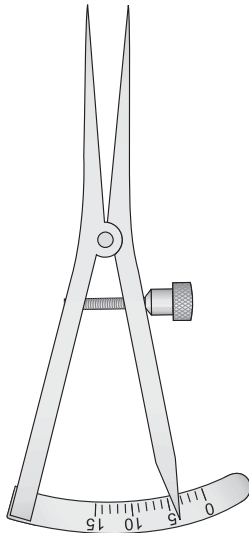

**CASTROVIEJO**  
**WIS-OR-15**  
90 mm

Meßbereich: 0 - 20 mm  
Measuring range: 0 - 20 mm  
Campo di misura: 0 - 20 mm  
Alcance de medición: 0 - 20 mm  
Etendue de mesure: 0 - 20 mm

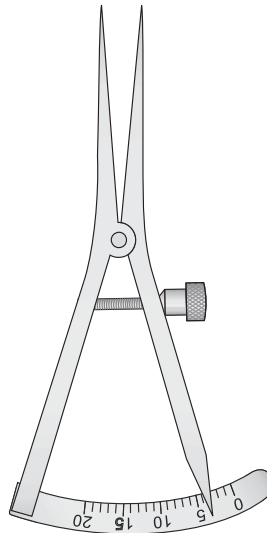

**CASTROVIEJO**  
**WIS-OR-17**  
90 mm

Meßbereich: 0 - 20 mm  
Measuring range: 0 - 20 mm  
Campo di misura: 0 - 20 mm  
Alcance de medición: 0 - 20 mm  
Etendue de mesure: 0 - 20 mm

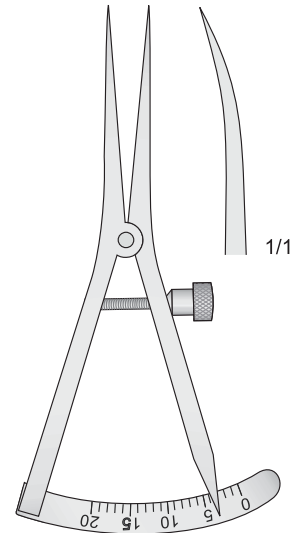

**CASTROVIEJO**  
**WIS-OR-19**  
90 mm

**Forceps for plattes**

Biege und schränkhebel  
Pinces à courber pour plaques  
Pinzas para placas  
Pinze e chiavi per placche

**Wire Guides**

Drahtumführungsnadel  
Aiguilles passe-?ls  
Agujas pasa hilos  
Passa?li

**Needle Holders**

Nadelhalter  
Porte-aiguilles  
Porta-agujas  
Port?aghi

**Cutting Pliers**

Schneidezangen  
Pinces coupante  
Alicates de corte  
Tronchesi di taglio



Biegezange - Bending pliers - Pinze piegaplacche - Pincen ? plier

**WAA**WAAORTHO  
INDUSTRY  
Sialkot Pakistan

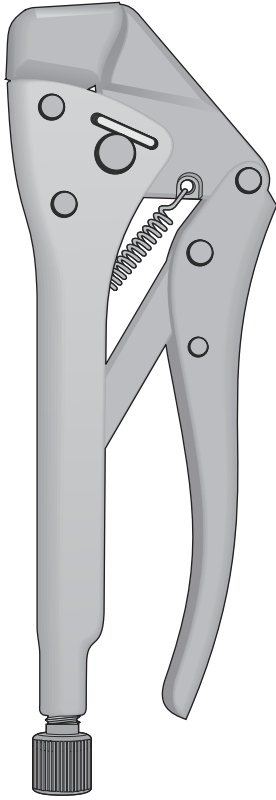

WIS-LS-405  
200 mm

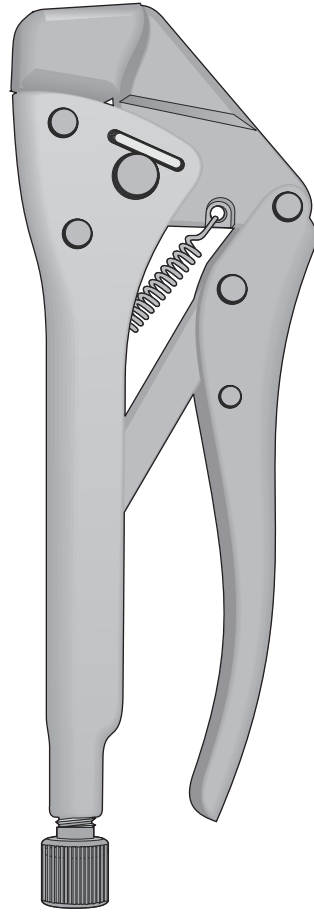

WIS-LS-406  
240 mm

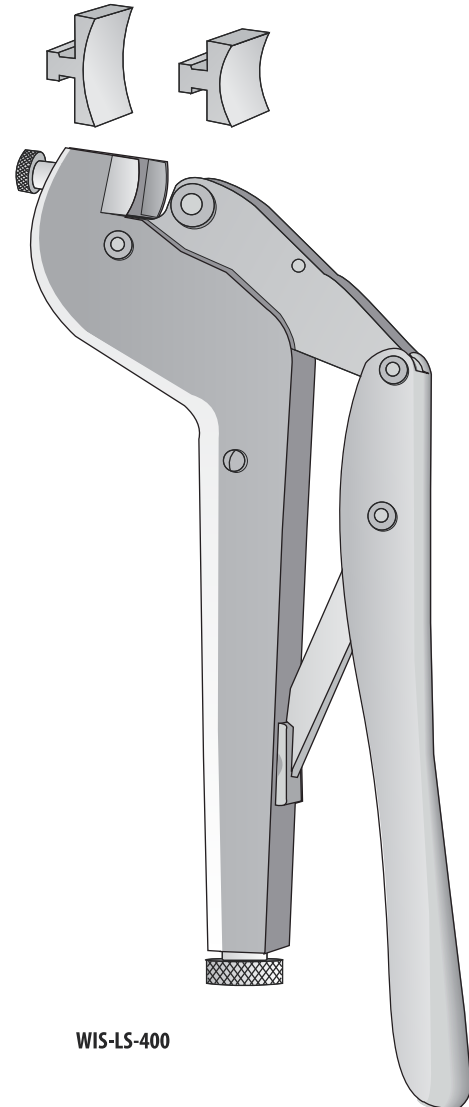

WIS-LS-400

Biegepresse - Bending press - Pressa piegaplacche - Presse pour plier

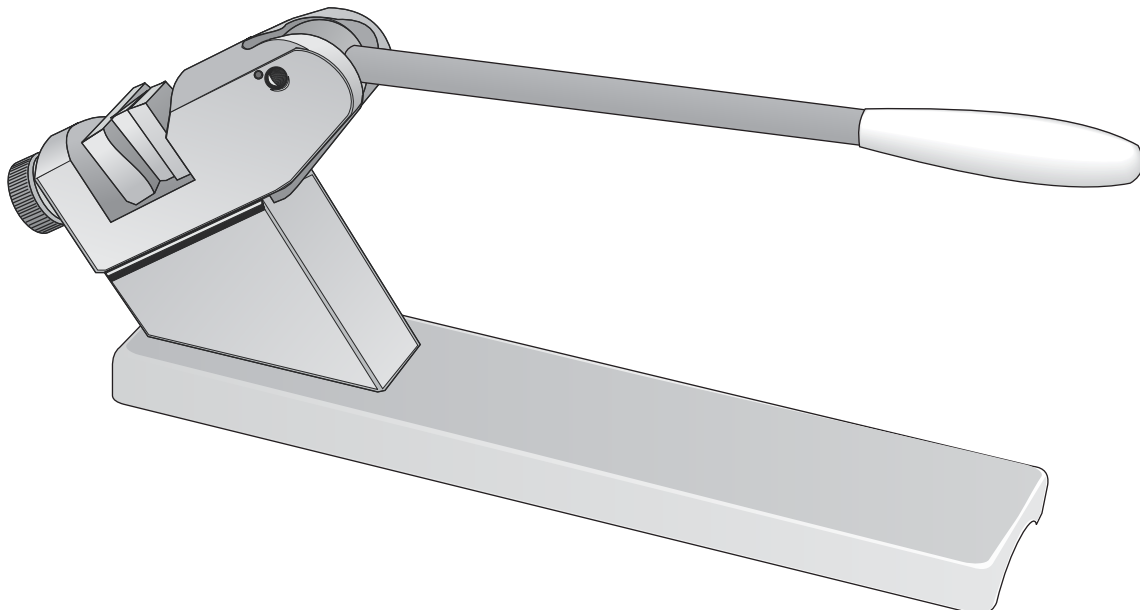

WIS-LS-410

Forceps  
for plattes

Zangen für  
schränkhebel platten

Pinze  
per placche

Pinzas  
para placas

Pinces à courber  
pour plaques

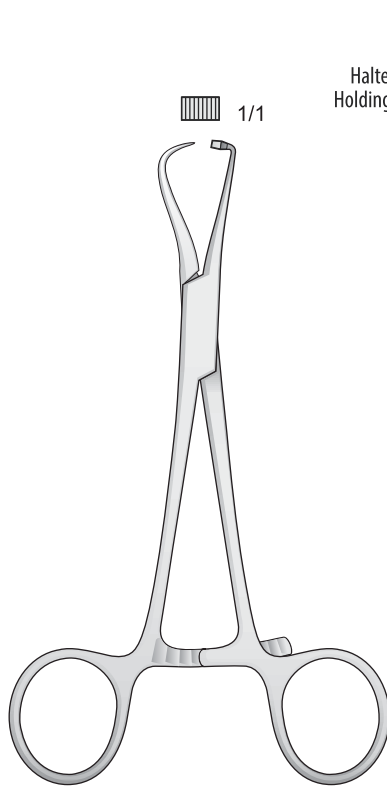

**WIS-LS-76**  
120 mm

Haltezange für platten  
Holding forceps for plates

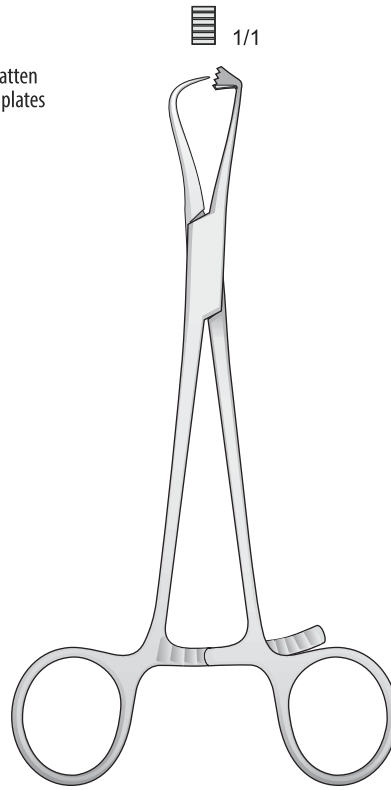

**WIS-LS-78**  
125 mm

Für Standard-Platten  
For standard plates

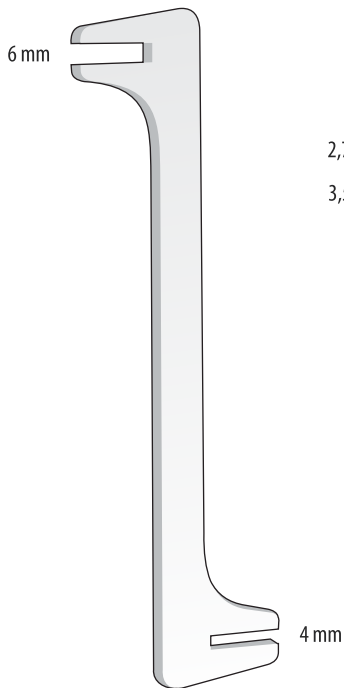

**WIS-LS-101**  
180 mm

Biege und Schränkhebel für kleine platten  
Bending irons, for small plates

Per placche da  
2,7 mm e 3,5 mm

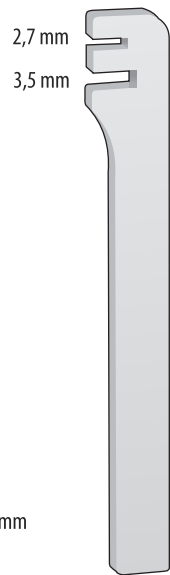

**WIS-LS-103** 100 mm  
**WIS-LS-102** 140 mm

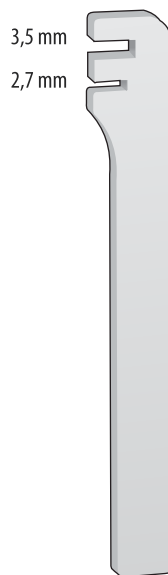

**WIS-LS-123** 100 mm  
**WIS-LS-122** 140 mm



**WIS-LS-104**  
100 mm

For standard plates  
Für Standard-Platten

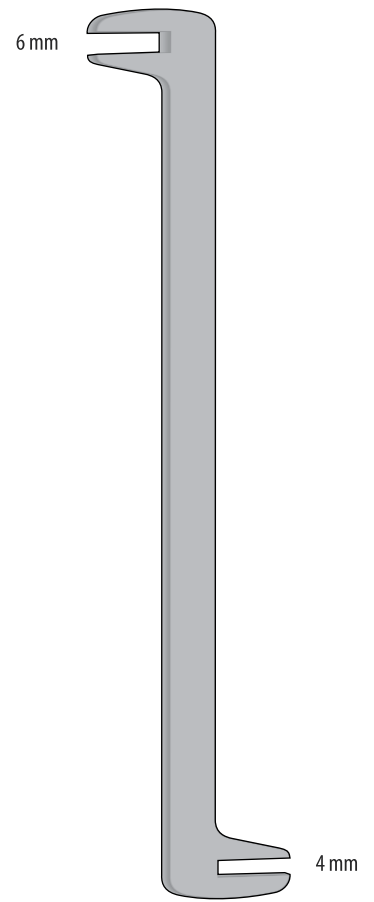

**WIS-LS-105**  
250 mm

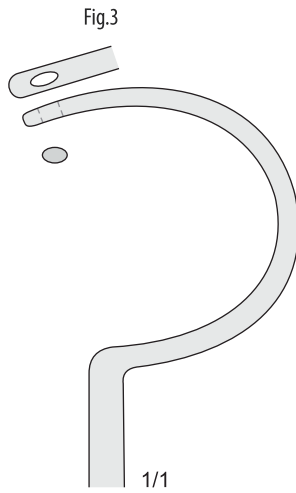
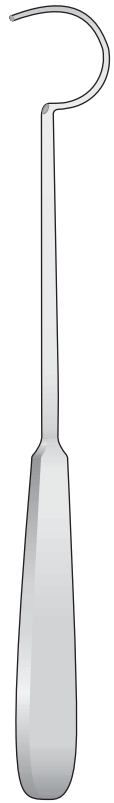

**WIS-BM-12**  
275 mm

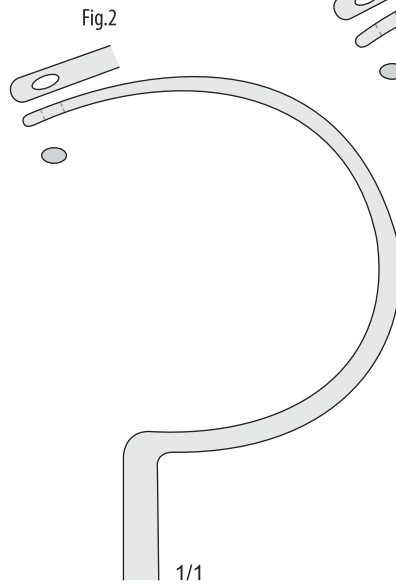

**WIS-BM-13**  
285 mm

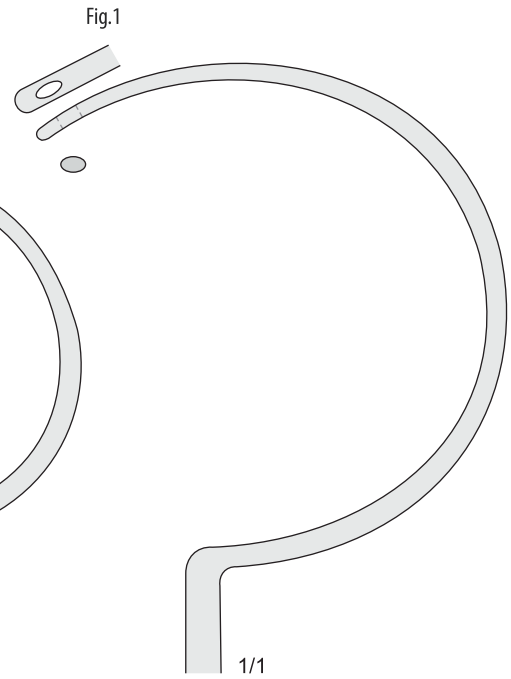

**WIS-BM-14**  
295 mm

DEMEL  
**WIS-BM-12/WIS-BM-14**

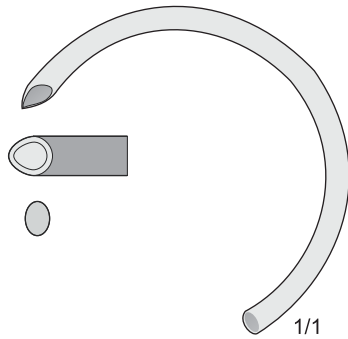
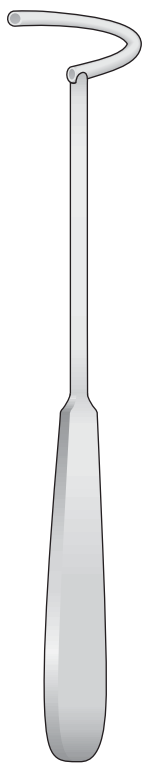

**WIS-BM-10**  
225 mm

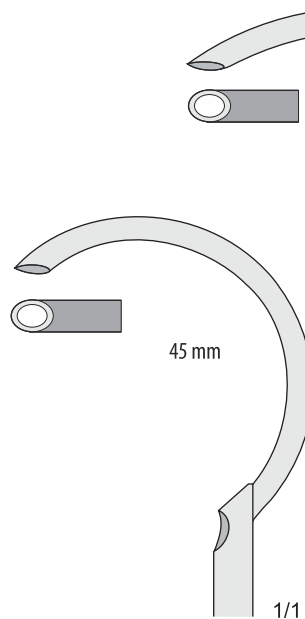

**WIS-BM-11**  
240 mm

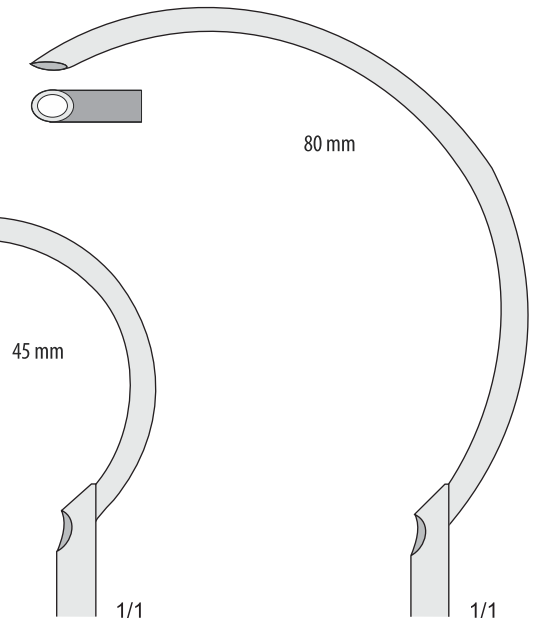

**WIS-BM-09**  
270 mm

**WIS-BM-10**  
225 mm

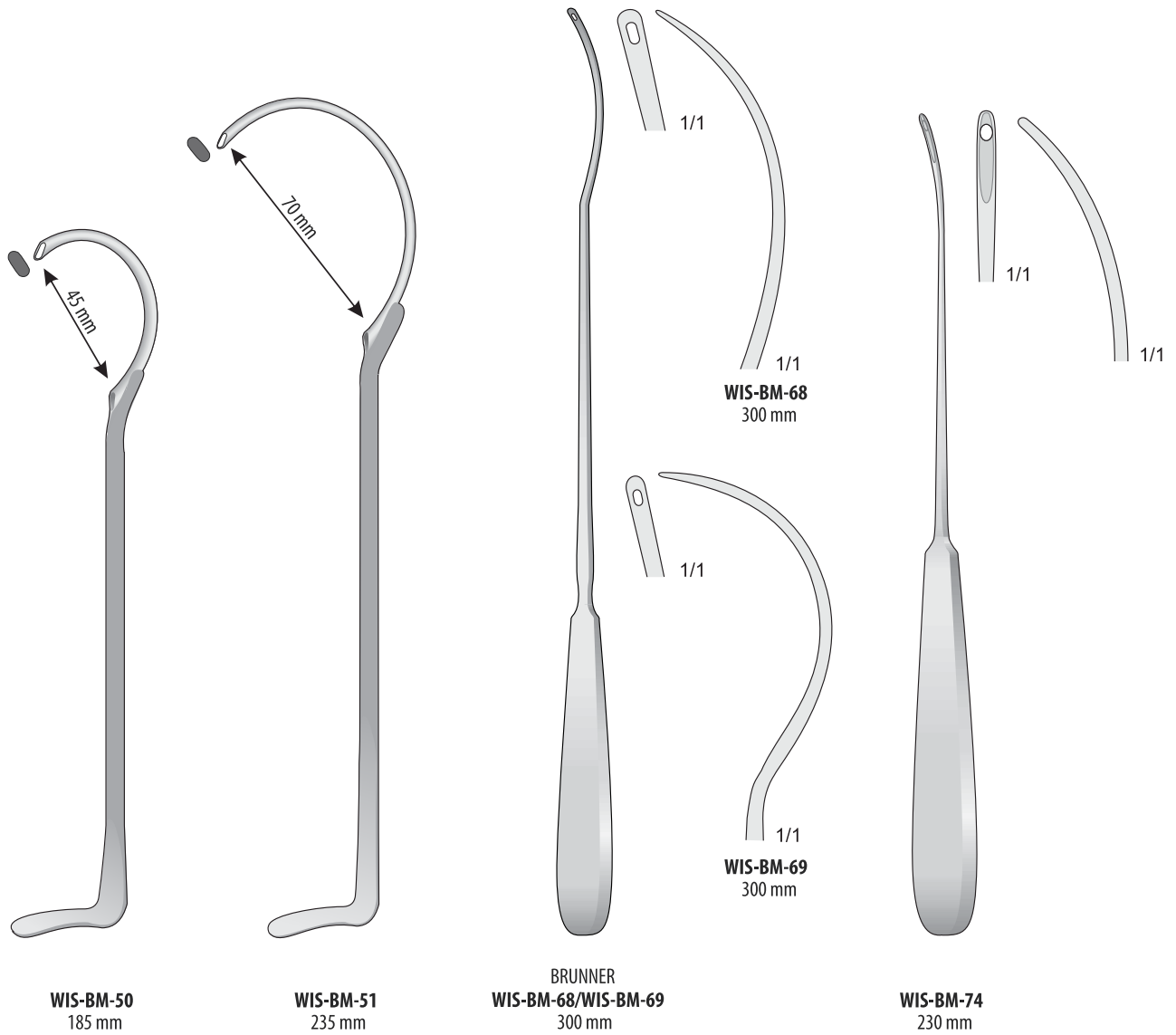

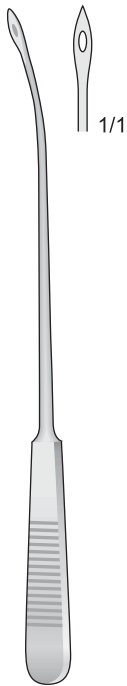

**OBWEGESER  
WIS-D0-30**  
140 mm

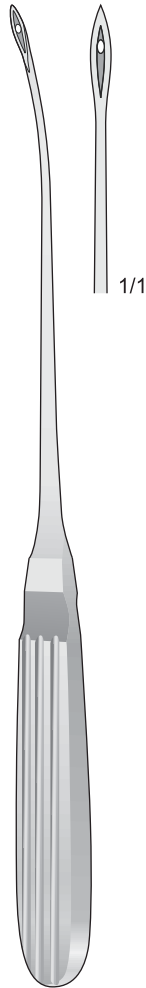

**OBWEGESER  
WIS-D0-31**  
230 mm

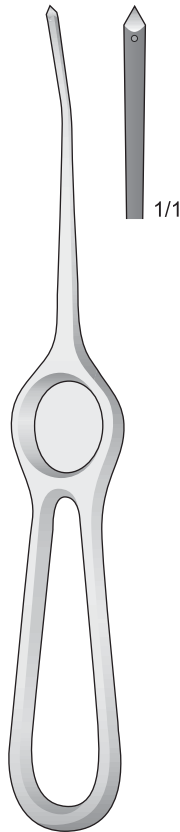

**WIS-D0-32**  
180 mm

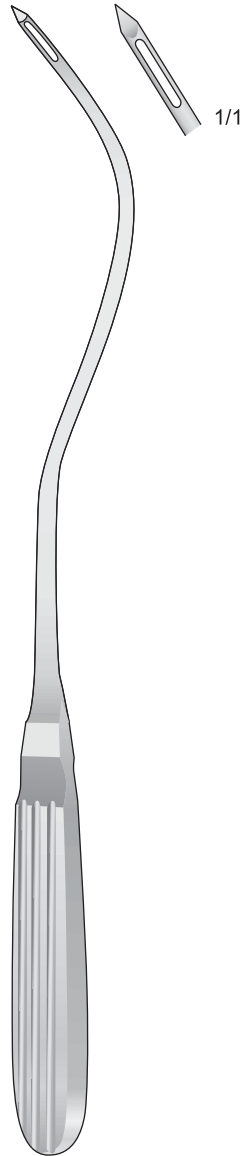

**SANDERS-BROWN  
WIS-D0-44**  
290 mm

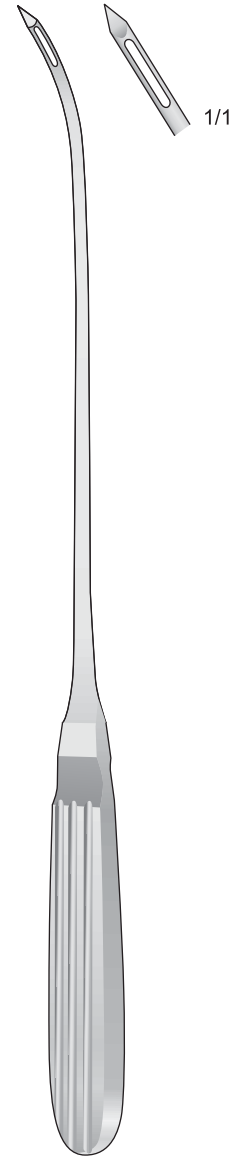

**SANDERS-BROWN  
WIS-D0-49**  
300 mm

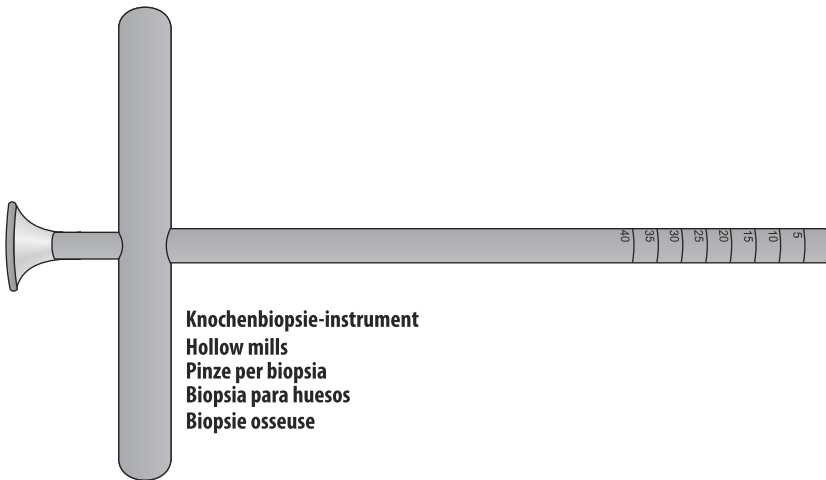

**Knochenbiopsie-instrument**  
Hollow mills  
Pinze per biopsia  
Biopsia para huesos  
Biopsie osseuse



**WIS-FK-92**  
170 mm

Innen	Außen
Inside	Outside
Interno	Esterno
Interior	Exterior
Intérieur	Extérieur
3 mm	4 mm



**WIS-FK-90**  
170 mm

Innen	Außen
Inside	Outside
Interno	Esterno
Interior	Exterior
Intérieur	Extérieur
3,9 mm	5 mm



**WIS-FK-91**  
170 mm

Innen	Außen
Inside	Outside
Interno	Esterno
Interior	Exterior
Intérieur	Extérieur
6,4 mm	8 mm

Extraktionszangen  
für bohrdrähte

Extraction pliers  
for wire

Pinze d'estrazione  
per fili metallici

Pinzas de extracción  
para hilo metálico

Pinces pour l'extraction  
pour fil métallique

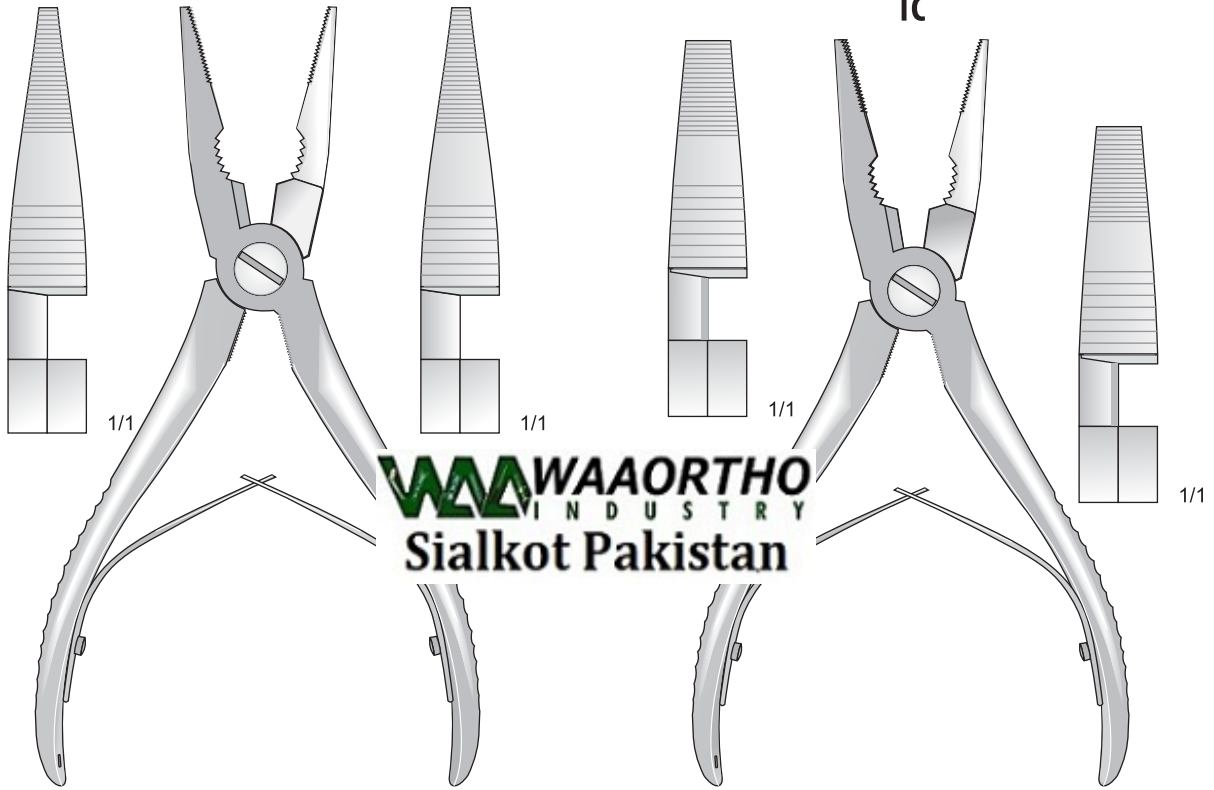

**WIS-LX-135**  
175 mm

**WIS-LX-136**  
165 mm

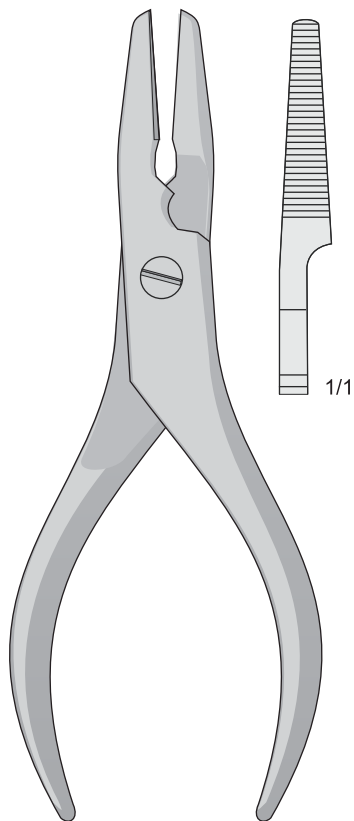

**WIS-LX-134**  
160 mm

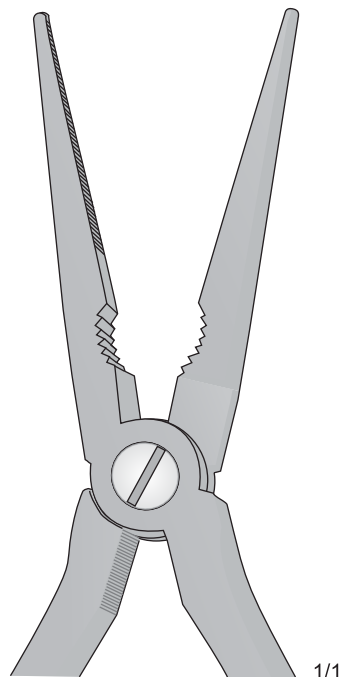

**WIS-LX-137**  
200 mm

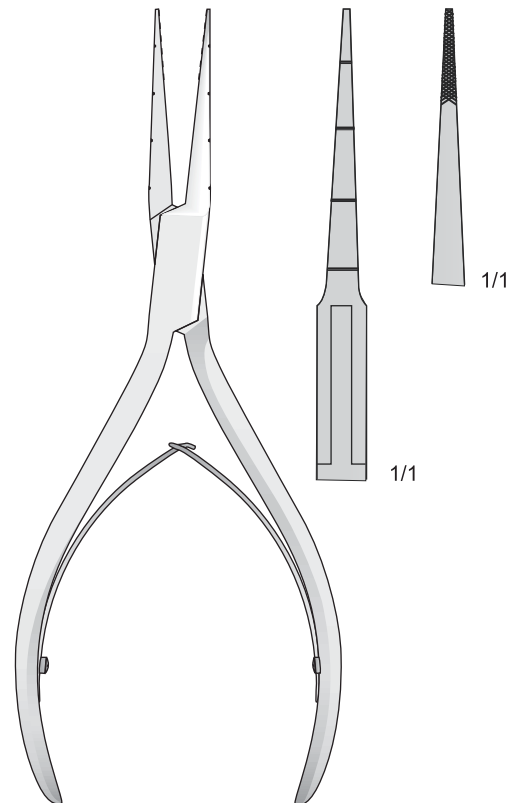

**WIS-DP-96**  
150 mm

Extraktionszangen  
für Bohrdrähte

Extraction pliers  
for wire

Pinze d'estrazione  
per fili metallici

Pinzas de extracción  
para hilo metálico

Pinces pour l'extraction  
pour fil métallique

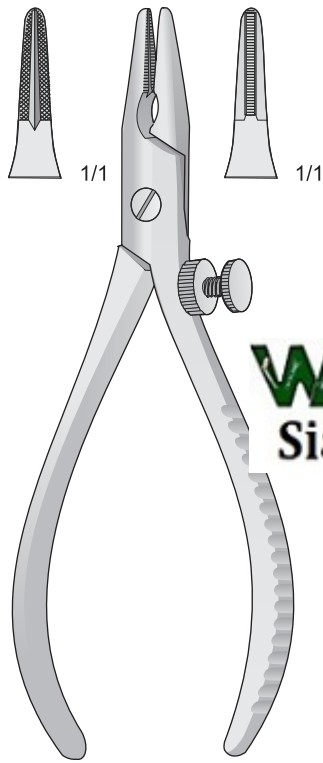

**WIS-LX-130**  
140 mm

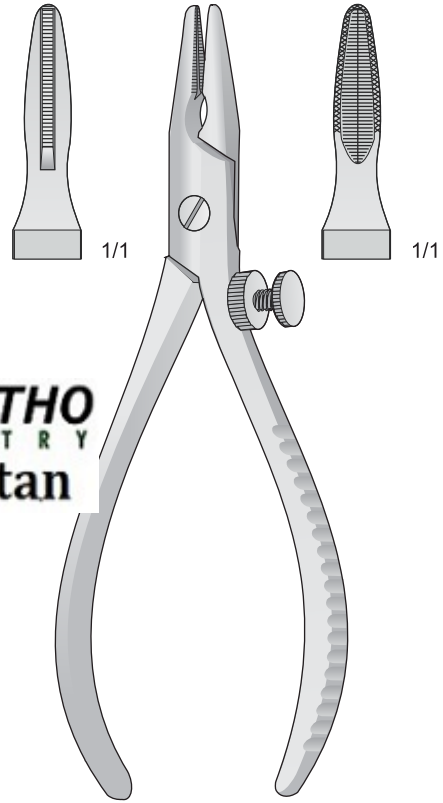

**WIS-LX-131**  
180 mm

**WAA** WAAORTHO  
INDUSTRY  
Sialkot Pakistan

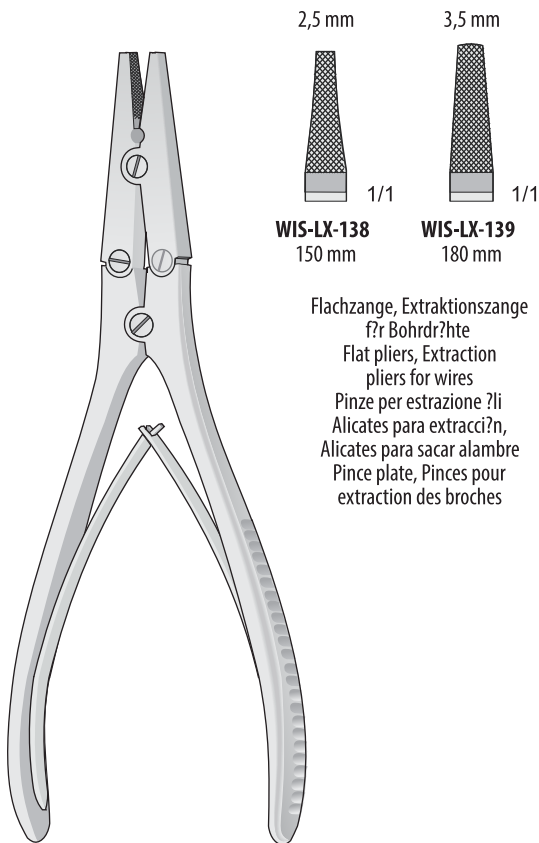

**WIS-LX-138**  
150 mm

**WIS-LX-139**  
180 mm

Flachzange, Extraktionszange  
für Bohrdrähte  
Flat pliers, Extraction  
pliers for wires  
Pinze per estrazione fili  
Alicates para extracción,  
Alicates para sacar alambre  
Pince plate, Pinces pour  
extraction des broches

**WIS-LX-138/WIS-LX-139**

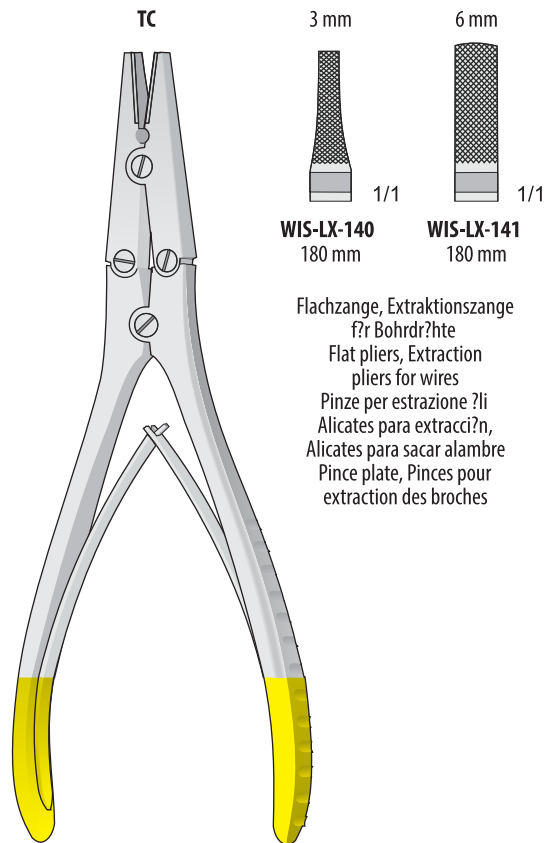

**WIS-LX-140**  
180 mm

**WIS-LX-141**  
180 mm

Flachzange, Extraktionszange  
für Bohrdrähte  
Flat pliers, Extraction  
pliers for wires  
Pinze per estrazione fili  
Alicates para extracción,  
Alicates para sacar alambre  
Pince plate, Pinces pour  
extraction des broches

**WIS-LX-140/WIS-LX-141**

Extraktionszangen  
für Bohrdrähte

Extraction pliers  
for wire

Pinze d'estrazione  
per fili metallici

Pinzas de extracción  
para hilo metálico

Pinces pour l'extraction  
pour fil métallique

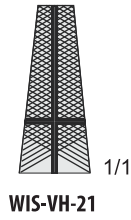
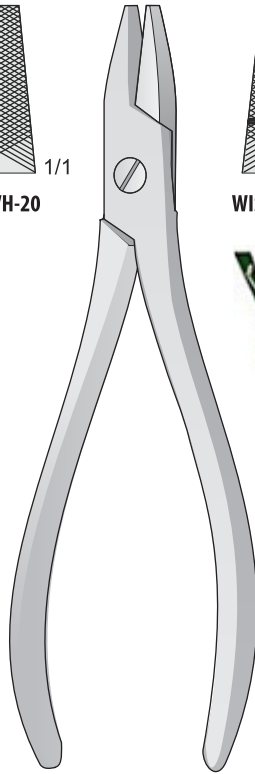
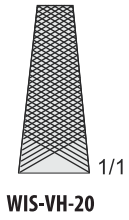

**WAAORTH O**  
INDUSTRY  
Sialkot Pakistan

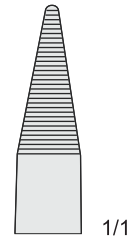
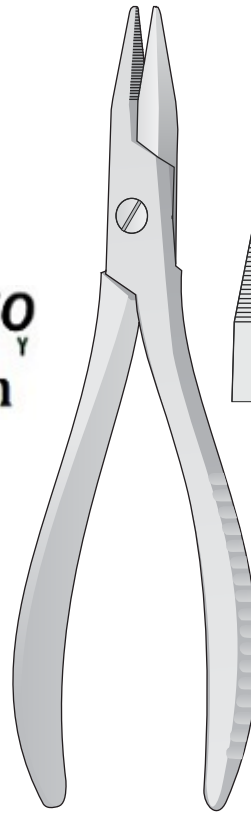

**WIS-VH-20/WIS-VH-21**  
175 mm

Parallel-Flachzange - Flat-nosed pliers, parallel  
Pinza a branche parallele - Alicates planos - Pinces plates

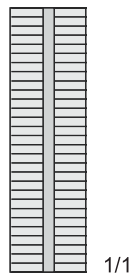
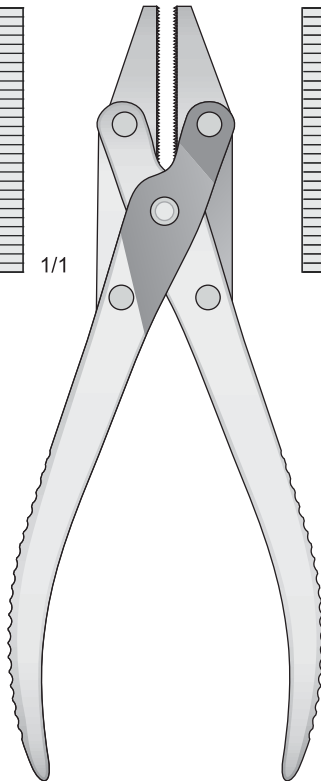
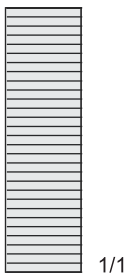

Inox  
Stainless Steel  
Rostfrei

**WIS-VH-25**  
185 mm

Parallel-Flachzange mit Seitenschneider  
Flat-nose pliers parallel with lateral wire cutter  
Pinza a branche parallele con tronchese

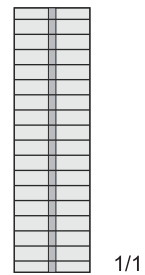
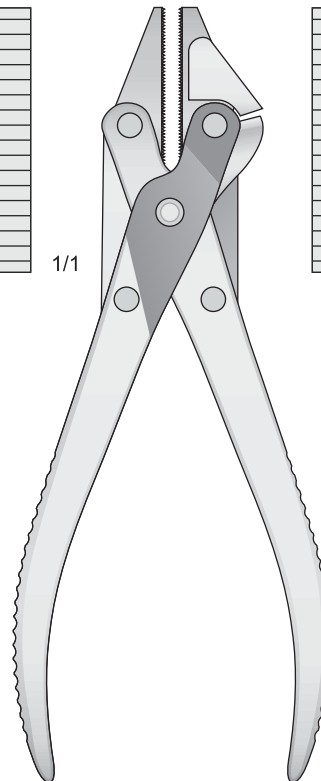
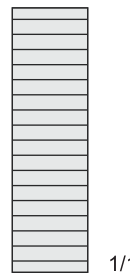

Inox  
Stainless Steel  
Rostfrei

**WIS-LX-80**  
185 mm



Draht-und blechscherer gezahnt - Wire cutting scissor serrated  
Forbice universale dentellata - Tijeras para cortar hilo de acero dentadas

TC

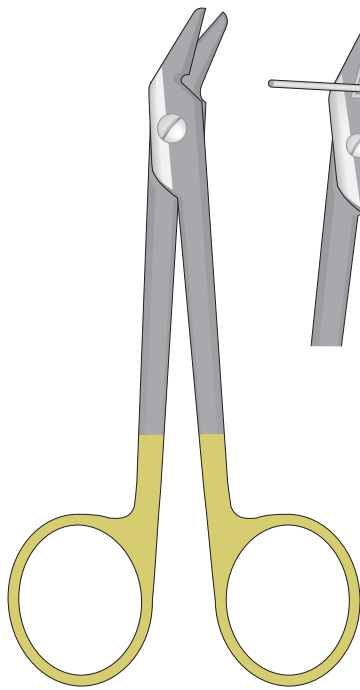

WIS-DP-120  
120 mm

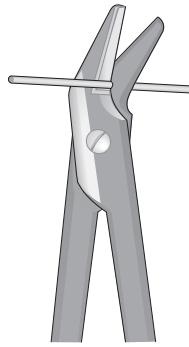

WIS-DP-90  
120 mm

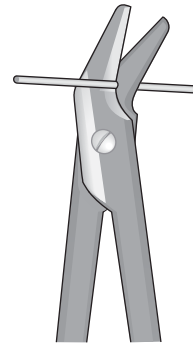

**WAA**WAAORTHO  
INDUSTRY  
Sialkot Pakistan

TC

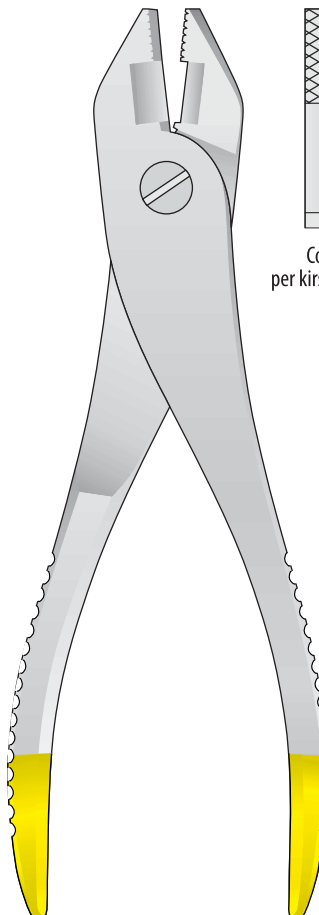

WIS-LX-125  
220 mm

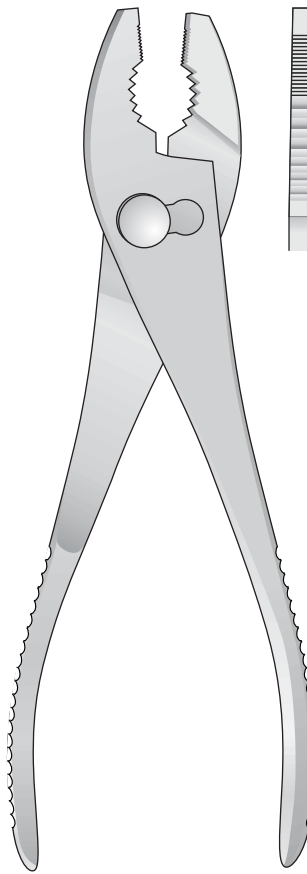
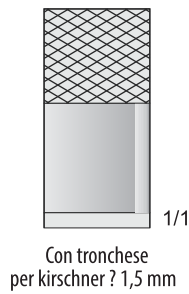

WIS-VH-40  
200 mm

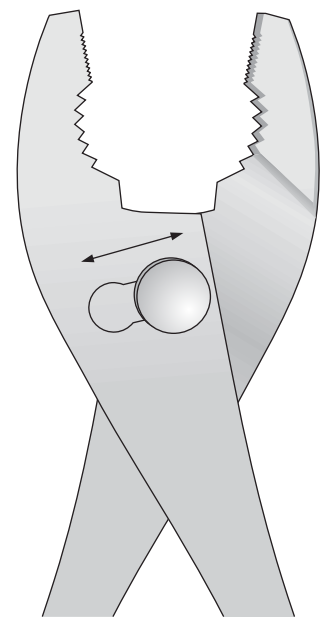

Komplett aus rostfreiem Stahl gefertigte und gehärtete Backen sorgen für einen guten Halt. Spannen und Lösen erfolgt mit einer Hand



**WIS-LS-407**  
180 mm



**WIS-LS-408**  
200 mm



**WIS-LS-409**  
240 mm

Nadelhalter  
r drahte

Needle Holders  
for wire

Port'aghi  
per fili metallici

Portaagujas  
para hilo metalico

Porte aiguilles  
pour fil metallique

**WAAORTH**  
INDUSTRY  
**Sialkot Pakistan**

Needle Holder | Wire Forceps  
Nadelhalter | Draht-Zangen  
Porte-aiguilles | Pinces pour ?l  
Porta-agujas | Pinzas para alambre  
Port'aghi | Pinze per ?li

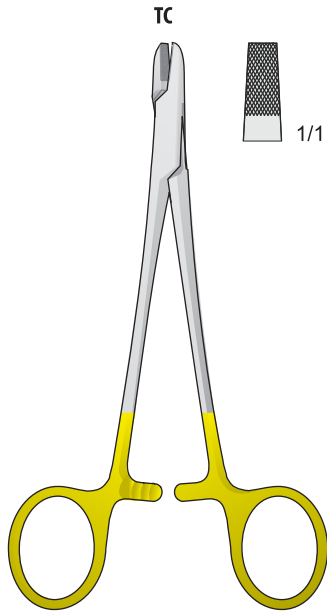

**WIS-PH-58**  
150 mm

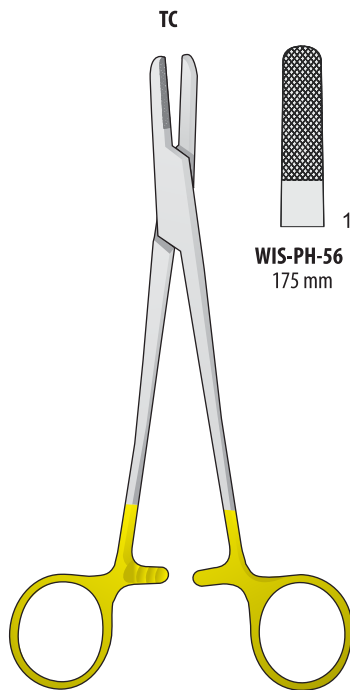

**WIS-PH-55/WIS-PH-56**

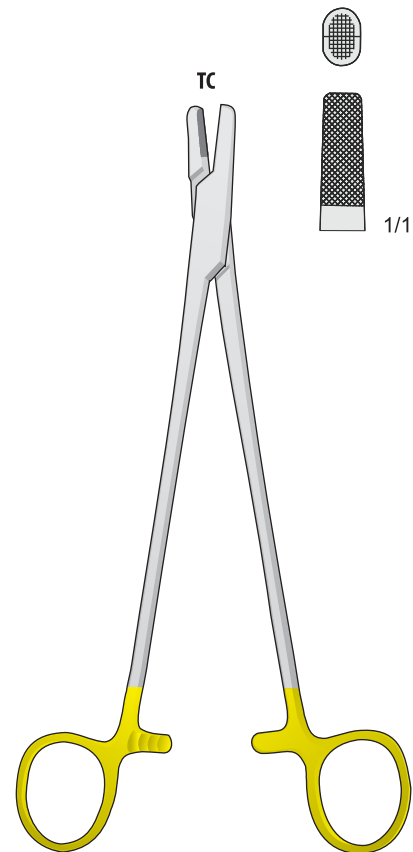
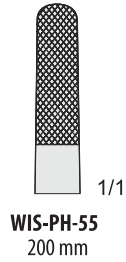
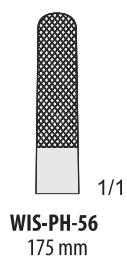

**BAUMGARTNER**  
**WIS-PH-57**  
200 mm

F?r harten Draht bis ? 0,4 mm - For hard wire with ? 0,4 mm  
Per ?li duri di ? 0,4 mm - Para alambres duros de ? 0,4 mm  
Pour ?ls durs avec ? 0,4 mm

F?r harten Draht bis ? 1 mm - For hard wire with ? 1 mm  
Per ?lo duro ? 1 mm - Para alambres duro ? 1 mm  
Pour ?l dur avec ? 1 mm

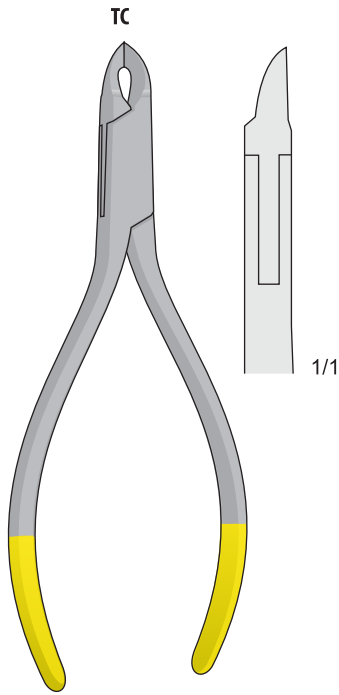

ANGLE  
**WIS-LX-95TC**  
130 mm

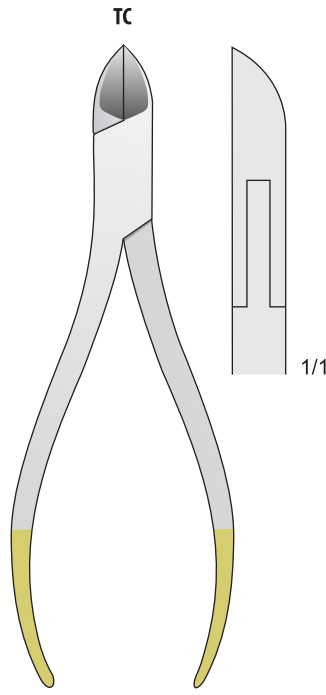

**WIS-LX-99**  
130 mm

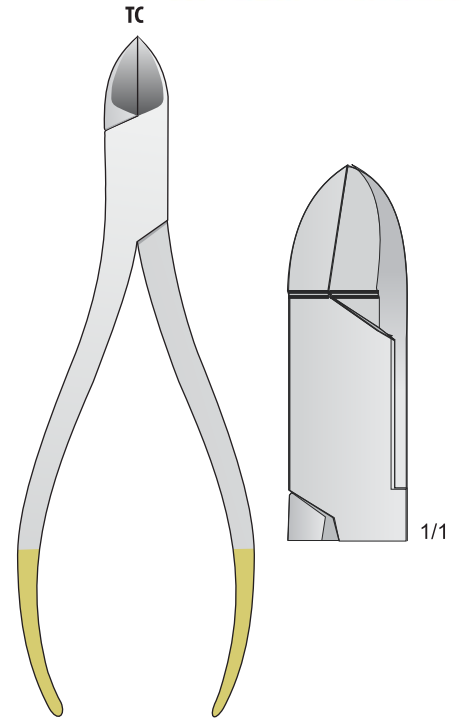

**WIS-LX-96TC**  
150 mm

F?r harten Draht bis ? 1 mm - For hard wire with ? 1 mm  
Per ?lo duro ? 1 mm - Para alambres duro ? 1 mm  
Pour ?l dur avec ? 1 mm

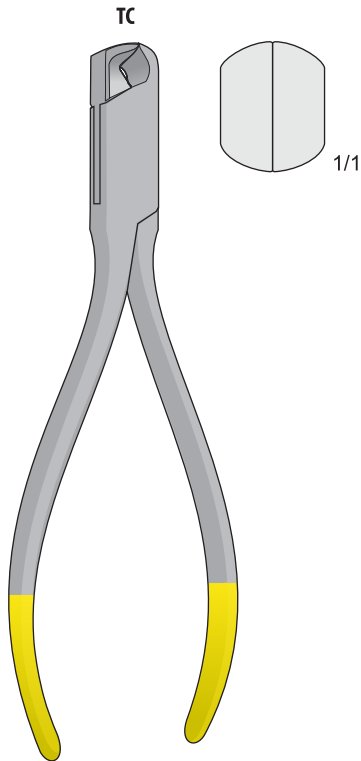

**WIS-LX-92TC**  
145 mm

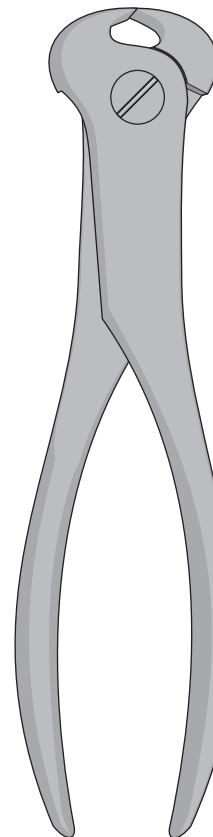

**WIS-LX-82**  
185 mm

F?r harten Draht bis ? 1,7 mm  
For hard wire with ? 1,7 mm  
Per ?lo duro ? 1,7 mm  
Para alambres duro ? 1,7 mm  
Pour ?l dur avec ? 1,7 mm

F?r weichen draht ? 2 mm  
 F?r harten draht ? 1,5 mm  
 For soft wire ? 2 mm  
 For hard wire ? 1,5 mm  
 Per ?lo leggero ? 2 mm  
 Per ?lo duro ? 1,5 mm  
 Para alambres ligero ? 2 mm  
 Para alambres duro 1,5 mm  
 Pour ?l l?ger ? 2 mm  
 Pour ?l dur ? 1,5 mm

F?r weichen draht ? 2 mm  
 F?r harten draht ? 1,6 mm  
 For soft wire ? 2 mm  
 For hard wire ? 1,6 mm  
 Per ?lo leggero ? 2 mm  
 Per ?lo duro ? 1,6 mm  
 Para alambres ligero ? 2 mm  
 Para alambres duro ? 1,6 mm  
 Pour ?l l?ger ? 2 mm  
 Pour ?l dur ? 1,6 mm

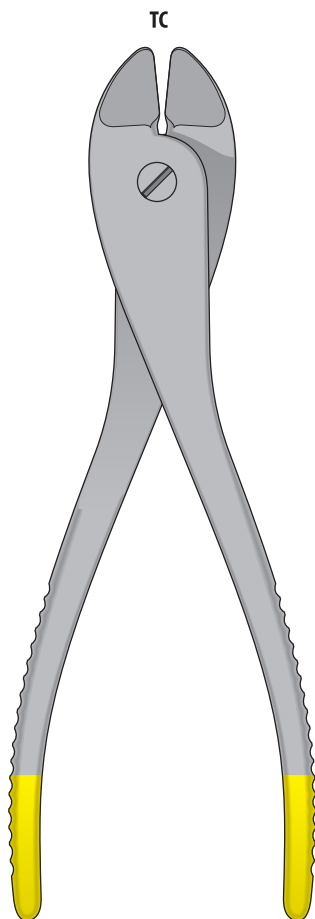

**WIS-LX-101**  
185 mm

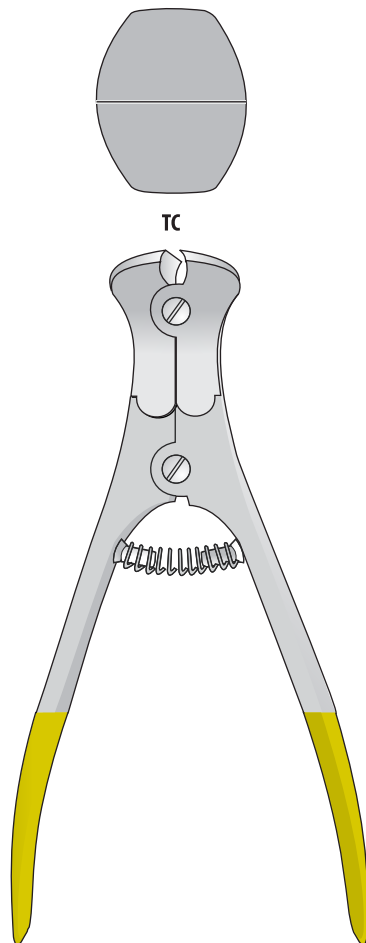

**WIS-LX-102**  
145 mm

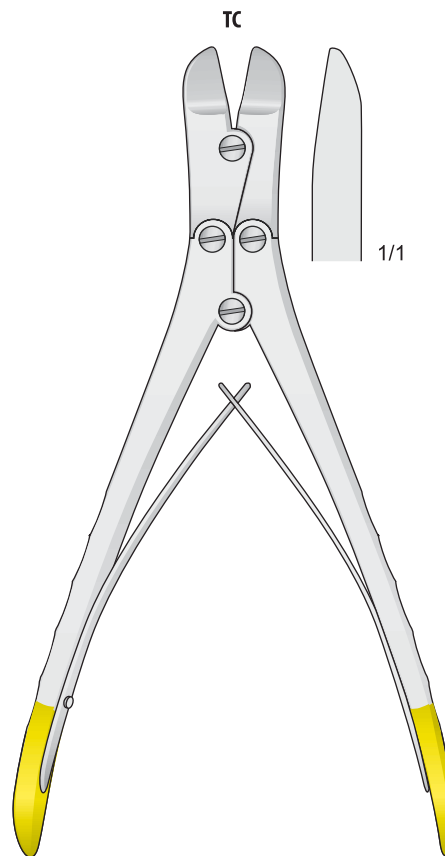

**WIS-LX-103**  
170 mm

F?r weichen draht ? 3,5 mm  
 F?r harten draht ? 2,5 mm  
 For soft wire ? 3,5 mm  
 For hard wire ? 2,5 mm  
 Per ?lo leggero ? 3,5 mm  
 Per ?lo duro ? 2,5 mm  
 Para alambres ligero ? 3,5 mm  
 Para alambres duro ? 2,5 mm  
 Pour ?l l?ger ? 3,5 mm  
 Pour ?l dur ? 2,5 mm

F?r weichen draht ? 3 mm  
 F?r harten draht ? 2,2 mm  
 For soft wire ? 3 mm  
 For hard wire ? 2,2 mm  
 Per ?lo leggero ? 3 mm  
 Per ?lo duro ? 2,2 mm  
 Para alambres ligero ? 3 mm  
 Para alambres duro ? 2,2 mm  
 Pour ?l l?ger ? 3 mm  
 Pour ?l dur ? 2,2 mm

F?r weichen draht ? 2,5 mm  
 F?r harten draht ? 2 mm  
 For soft wire ? 2,5 mm  
 For hard wire ? 2 mm  
 Per ?lo leggero ? 2,5 mm  
 Per ?lo duro ? 2 mm  
 Para alambres ligero ? 2,5 mm  
 Para alambres duro ? 2 mm  
 Pour ?l l?ger ? 2,5 mm  
 Pour ?l dur ? 2 mm

TC

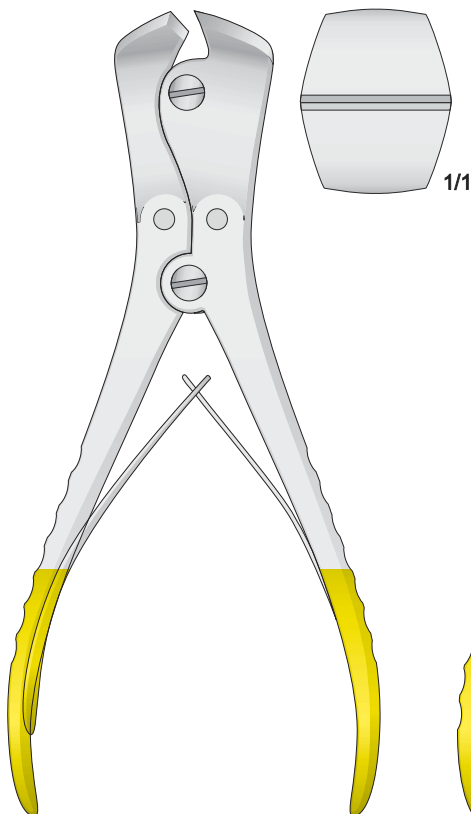

**WIS-LX-104**  
215 mm

TC

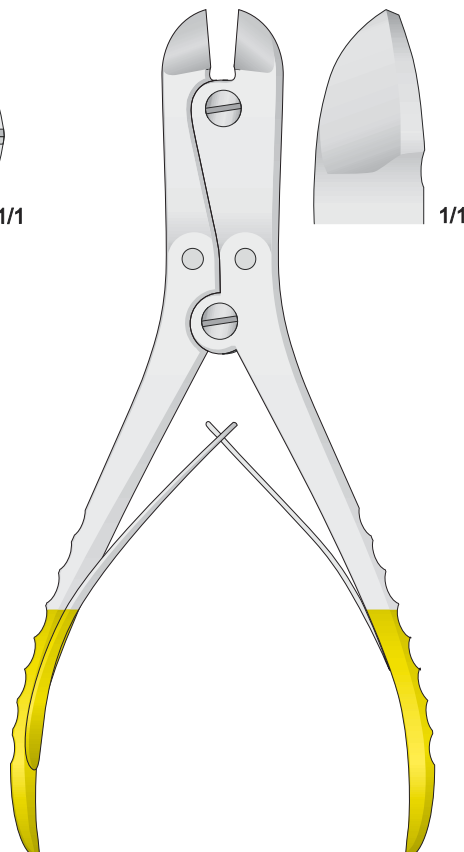

**WIS-LX-106**  
230 mm

TC

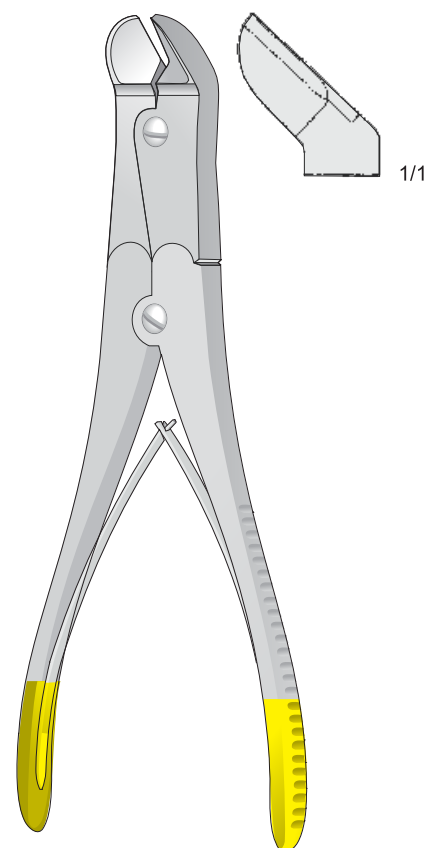

**WIS-LX-105**  
230 mm

F?r weichen Draht ? 7 mm  
 F?r harten Draht ? 6 mm  
 For soft wire ? 7 mm  
 For hard wire ? 6 mm  
 Per ?lo leggero ? 7 mm  
 Per ?lo duro ? 6 mm  
 Para alambres ligero ? 7 mm  
 Para alambres duro ? 6 mm  
 Pour ?l l?ger ? 7 mm  
 Pour ?l dur ? 6 mm

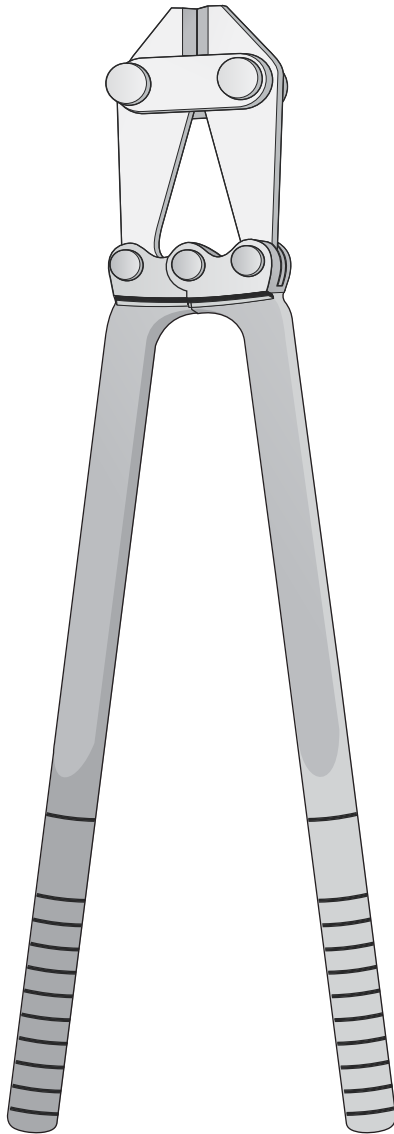

**WIS-VF-98**  
480 mm

F?r weichen Draht ? 7 mm  
 F?r harten Draht ? 6 mm  
 For soft wire ? 7 mm  
 For hard wire ? 6 mm  
 Per ?lo leggero ? 7 mm  
 Per ?lo duro ? 6 mm  
 Para alambres ligero ? 7 mm  
 Para alambres duro ? 6 mm  
 Pour ?l l?ger ? 7 mm  
 Pour ?l dur ? 6 mm

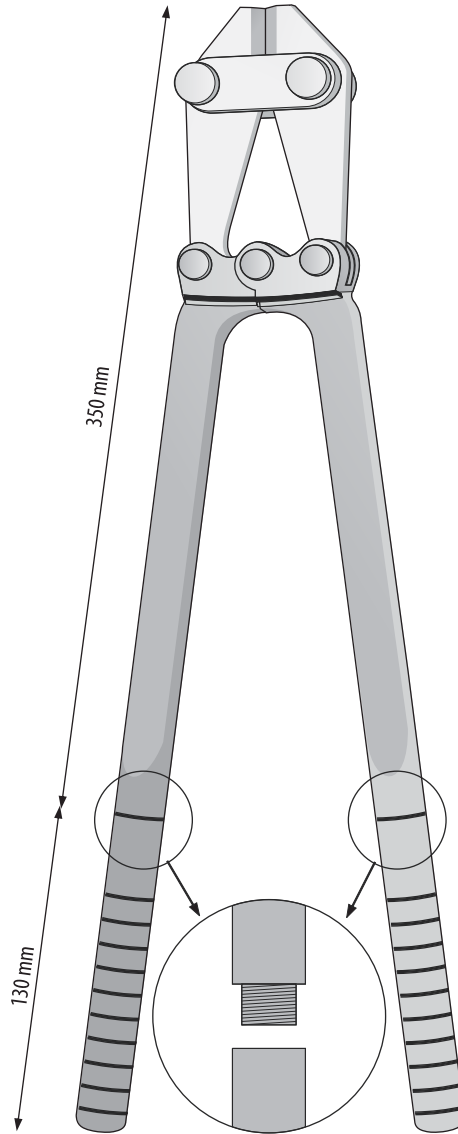

**WIS-VF-98M**  
480 mm

F?r weichen Draht ? 5 mm  
 F?r harten Draht ? 4,5 mm  
 For soft wire ? 5 mm  
 For hard wire ? 4,5 mm  
 Per ?lo leggero ? 5 mm  
 Per ?lo duro ? 4,5 mm  
 Para alambres ligero ? 5 mm  
 Para alambres duro ? 4,5 mm  
 Pour ?l l?ger ? 5 mm  
 Pour ?l dur ? 4,5 mm

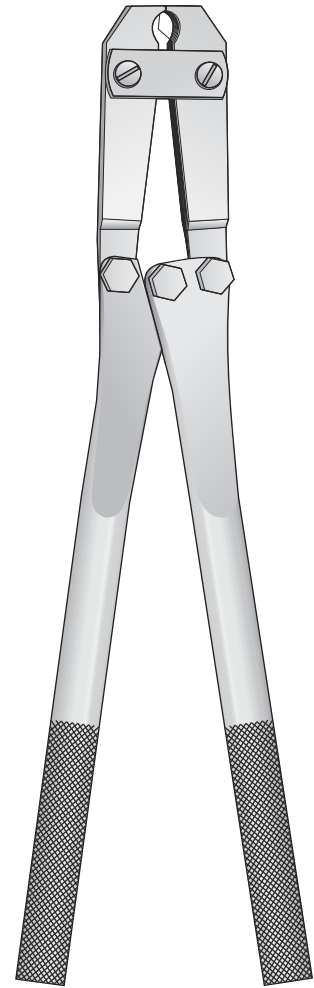

**WIS-LX-107**  
375 mm

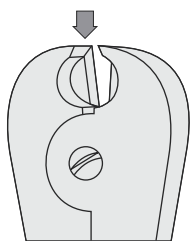

F?r weiche Dr?hte bis ? 2 mm  
Per ?li morbidi ?no a ? 2 mm  
Pour ?ls mous jusqu?? ? 2 mm

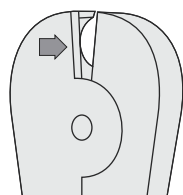

F?r harte Dr?hte bis ? 1,5 mm  
Per ?li duri ?no a ? 1,5 mm  
Pour ?ls durs jusqu?? ? 1,5 mm

TC



**WIS-LX-126**  
180 mm

Von Kirschner-Dr?hten ? 6 mm  
For Kirschner wires ? 6 mm  
Per chiodi Kirschner ? 6 mm

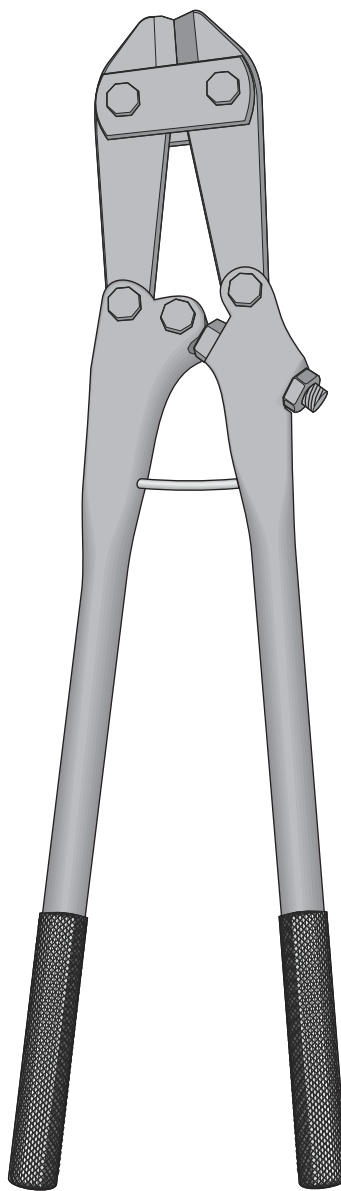

**WIS-LX-150**  
450 mm

Von Kirschner-Dr?hten  $\Omega$  6 mm  
For Kirschner wires ? 6 mm  
Per chiodi Kirschner ? 6 mm

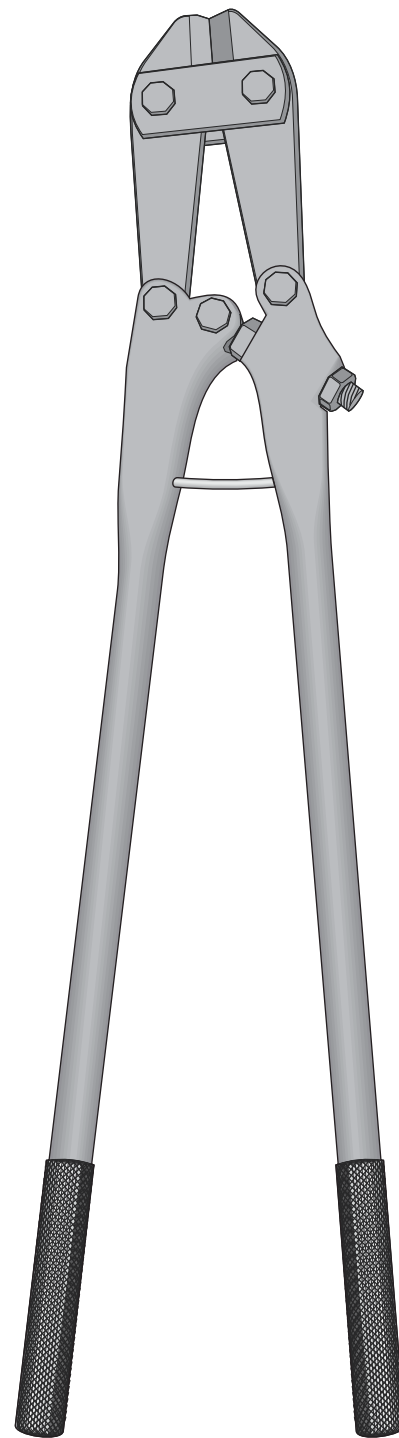

**WIS-LX-151**  
560 mm



Gipsspreizer  
Gipsabreisszangen

Plaster spreader  
Plaster cast breakers

Strumenti  
per gesso

Pinza para  
arrancar vendajes

Pinces pour  
appareils plâtrés

**WAAORTH**  
INDUSTRY  
**Sialkot Pakistan**

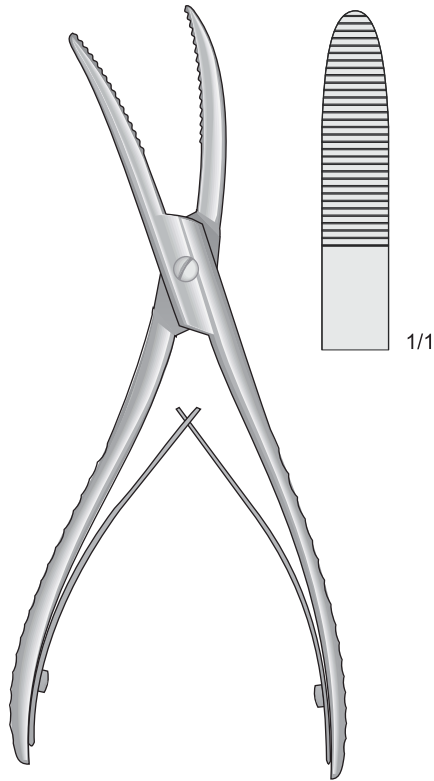

WOLFF  
WIS-LX-113  
180 mm

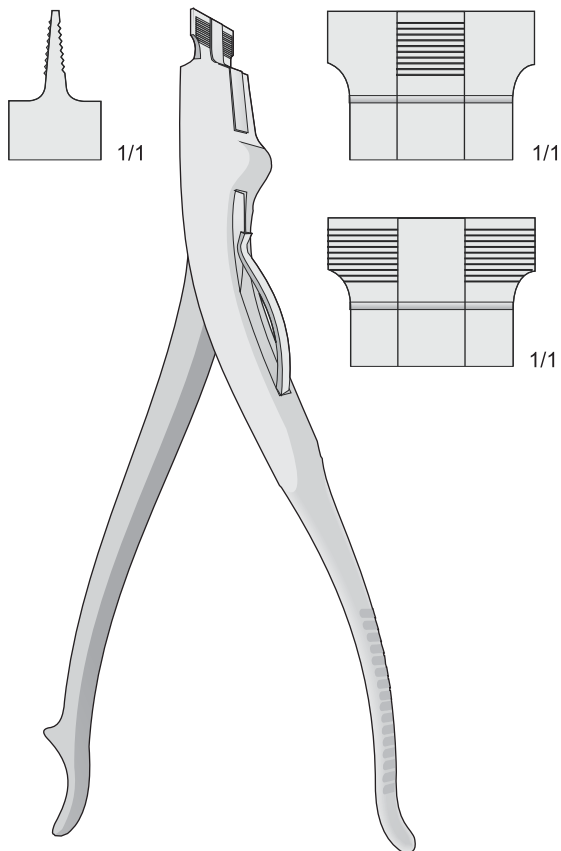

WIS-LX-115  
220 mm

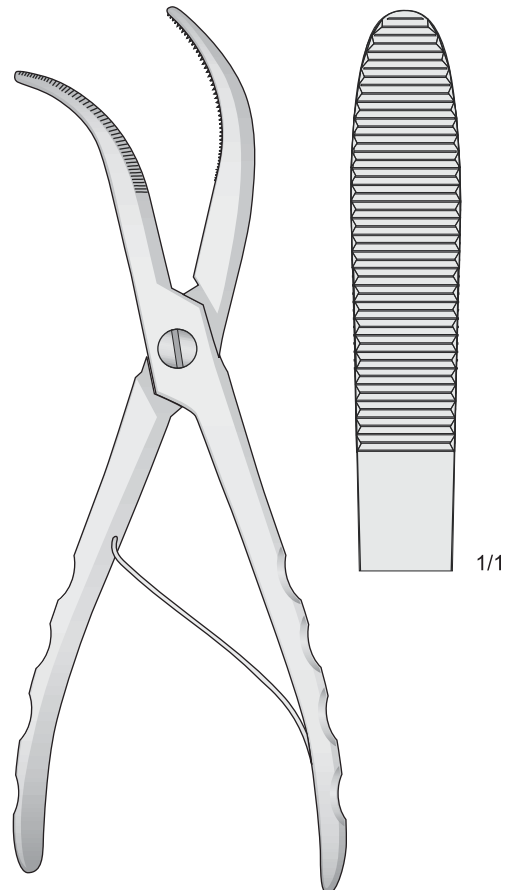

WOLFF  
WIS-LX-114  
250 mm

Gipsspreizer  
Gipsabreisszangen

Plaster spreader  
Plaster cast breakers

Strumenti  
per gesso

Pinza para  
arrancar vendajes

Pinces pour  
appareils plâtrés

**WAAORTH**  
INDUSTRY  
**Sialkot Pakistan**

Gips - Schneidezangen  
Cesoie per gesso

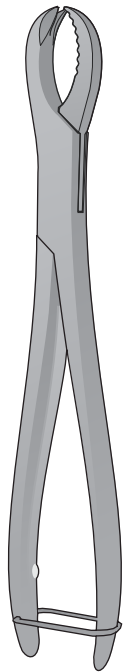

**WIS-BK-30**  
210 mm

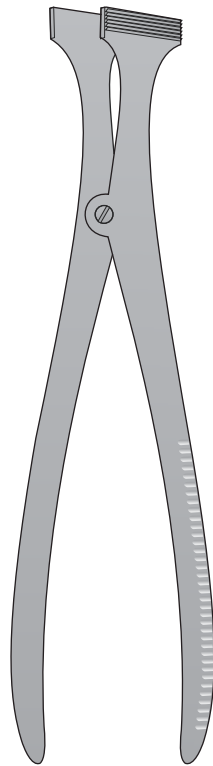

**HENNIG**  
**WIS-LX-123**  
270 mm

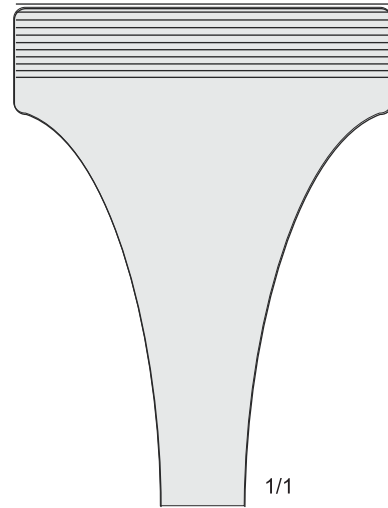

1/1

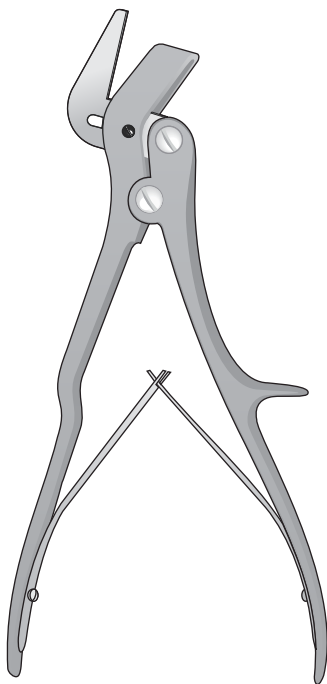

**STILLE**  
**WIS-LX-120**  
230 mm

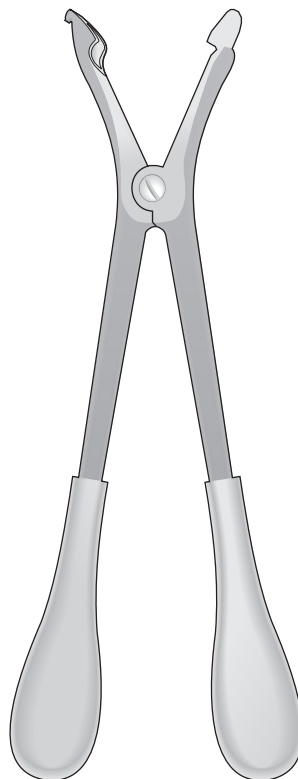

**HAGLUND**  
**WIS-LX-121**  
280 mm

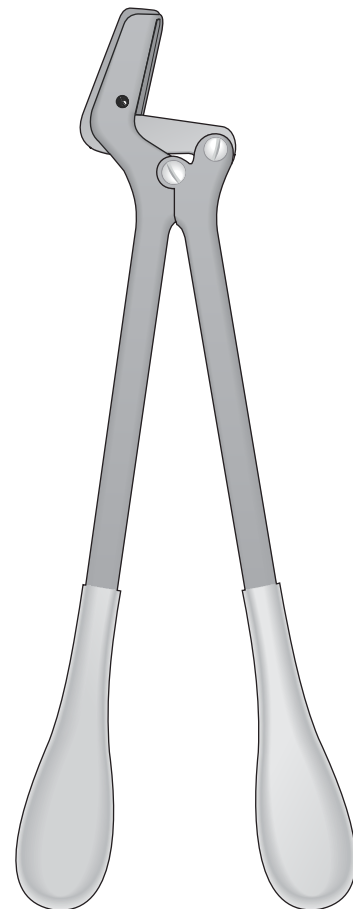

**STILLE**  
**WIS-LX-122**  
370 mm

**Retractors**

Retraktoren

Écarteurs

Separadores

Divaricatori

**Nervhaken**

Nerve Hooks

Crochets à nerfs

Ganchos para nervios

Uncini per nervi

**Micro Dissectors**

Mikro-Dissektoren

Micro Dissecteurs

Micro Disecadores

Micro Dissettori

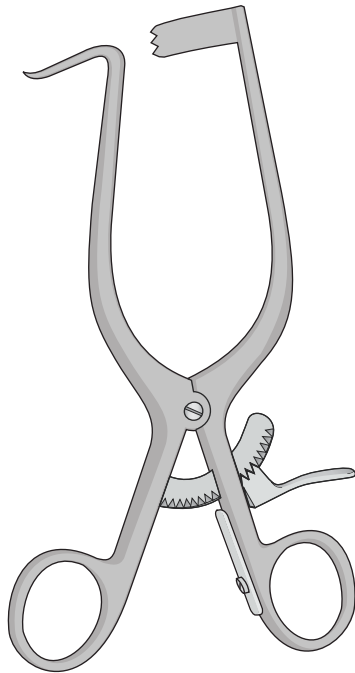

WILLIAMS  
WIS-BV-401/WIS-BV-403  
170 mm

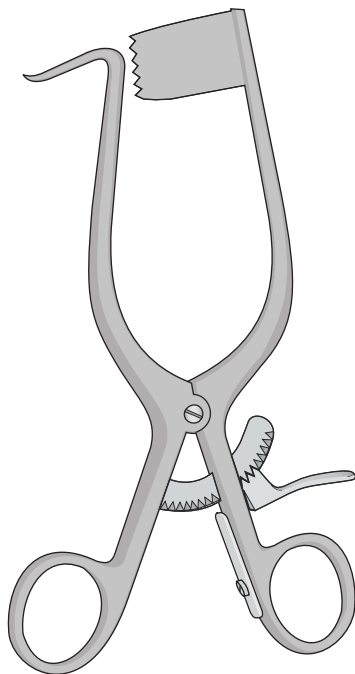

WILLIAMS  
WIS-BV-404/WIS-BV-406  
170 mm

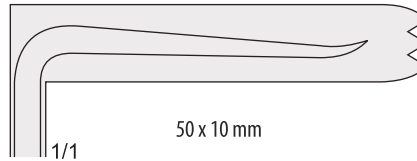

WIS-BV-401

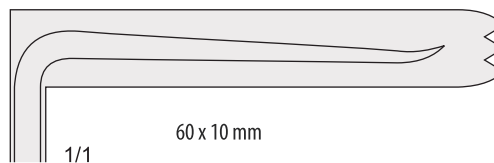

WIS-BV-402

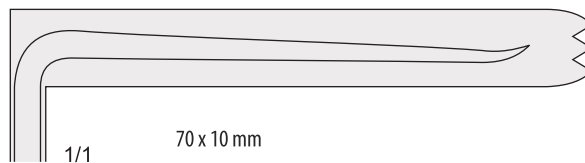

WIS-BV-403

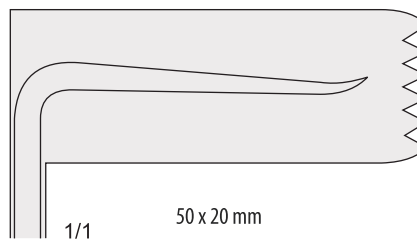

WIS-BV-404

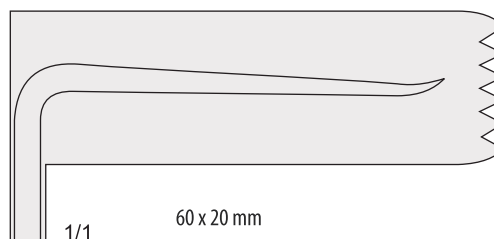

WIS-BV-405

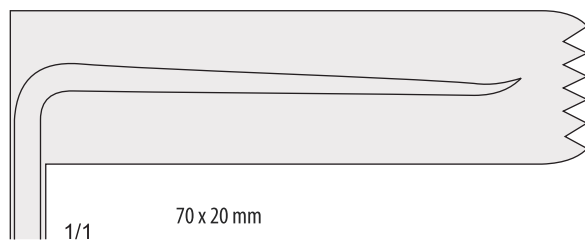

WIS-BV-406

Spitz - Sharp  
Acuto - Agudas  
Point?

4 x 4 Z?hne  
4 x 4 Teeth  
4 x 4 Denti  
4 x 4 Dientes  
4 x 4 Dents

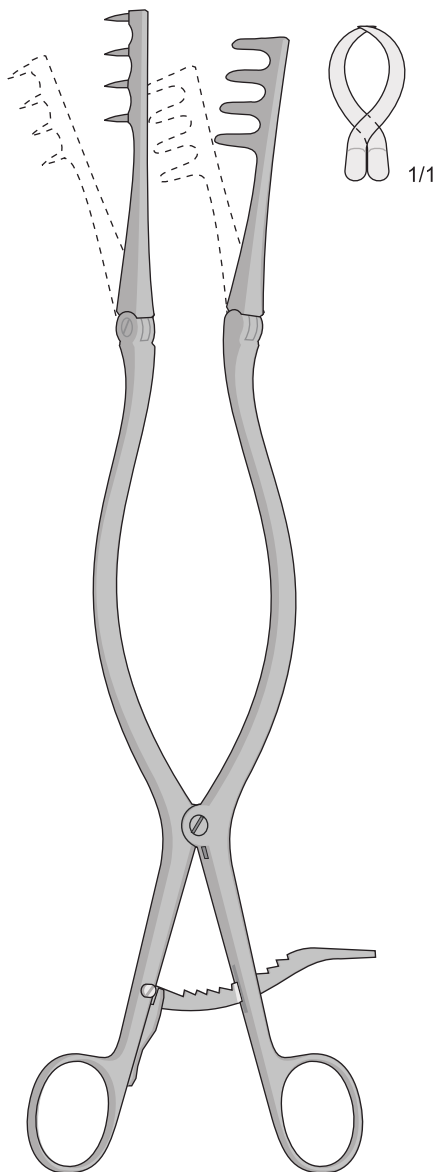

BECKMANN  
WIS-BV-121  
310 mm

Halbscharf - Sharp  
Semi acuto - Agudas  
Semi pointu

4 x 4 Z?hne  
4 x 4 Teeth  
4 x 4 Denti  
4 x 4 Dientes  
4 x 4 Dents

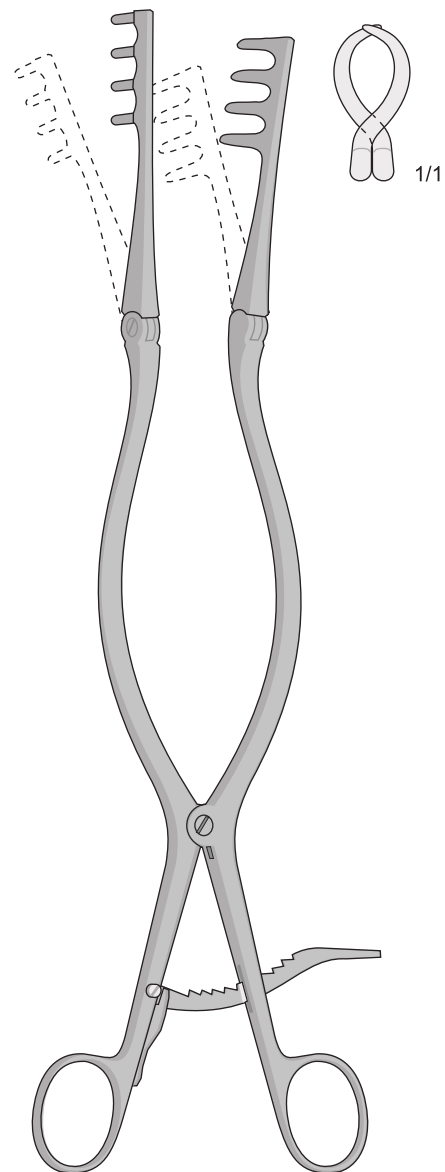

BECKMANN  
WIS-BV-122  
310 mm

Stumpf - Blunt - Smusso  
Romas - Mousse

5 x 4 Z?hne  
5 x 4 Teeth  
5 x 4 Denti  
5 x 4 Dientes  
5 x 4 Dents

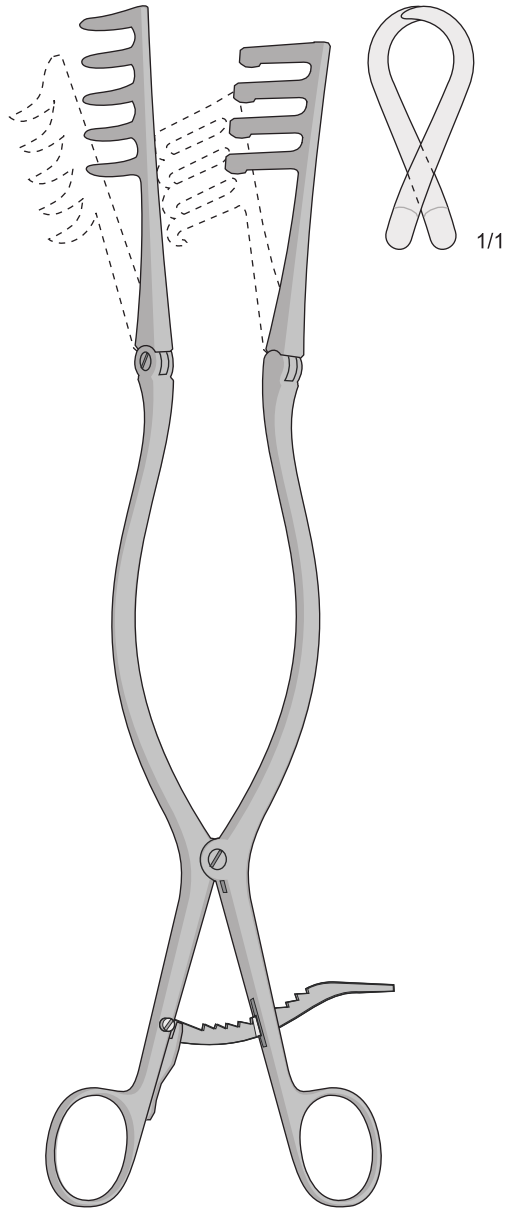

ADSON  
**WIS-BV-123**  
320 mm

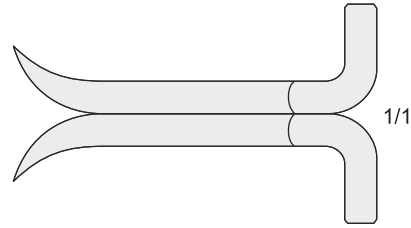

Spitz - Sharp - Acuto  
Agudas - Point?

7 x 7 Z?hne  
7 x 7 Teeth  
7 x 7 Denti  
7 x 7 Dientes  
7 x 7 Dents

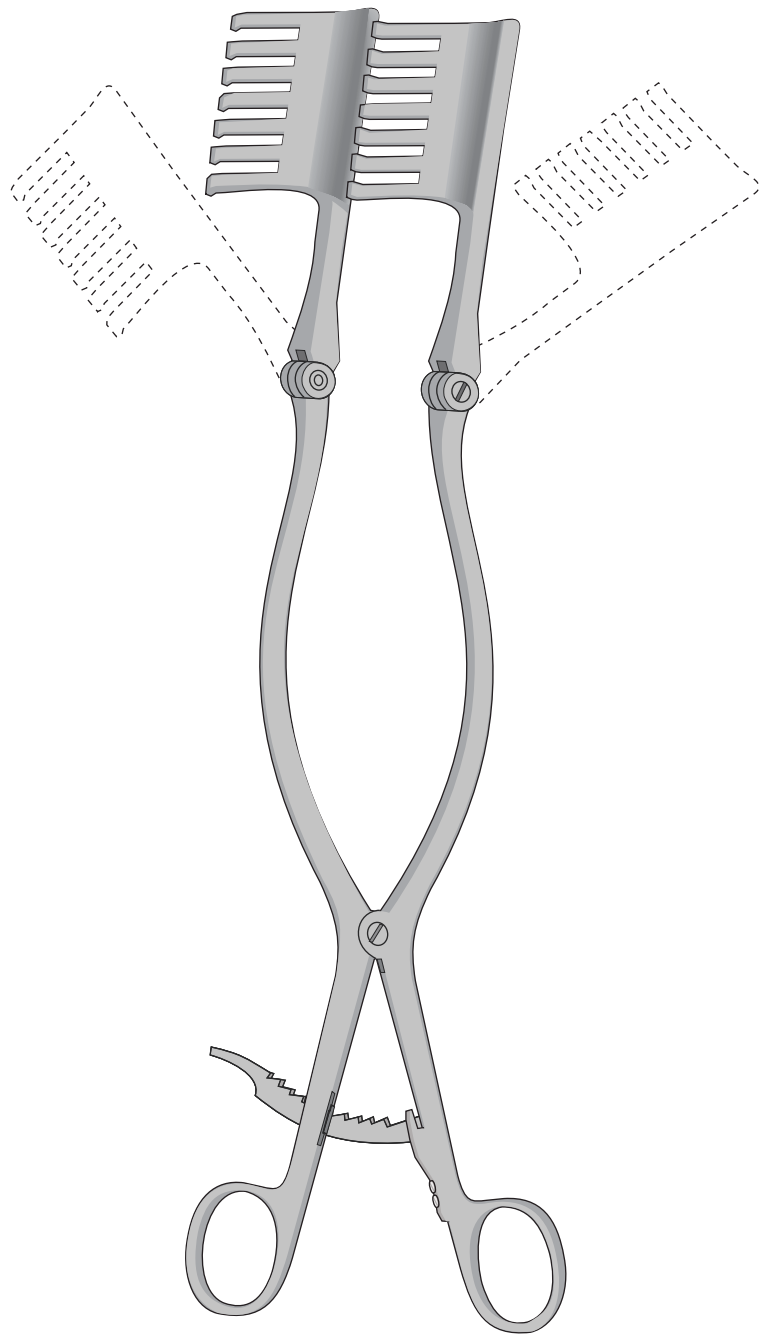

BECKMANN-EATON  
**WIS-BV-124**  
330 mm

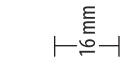
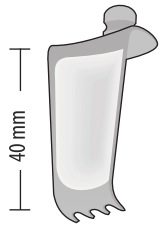

**WIS-BV-319**

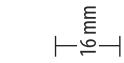
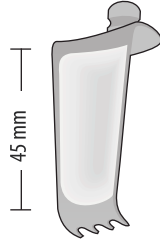

**WIS-BV-322**

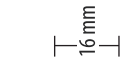
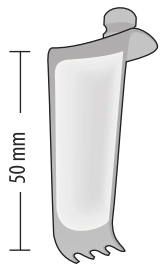

**WIS-BV-323**

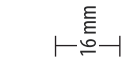
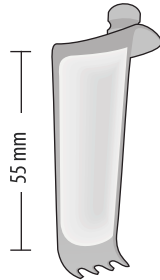

**WIS-BV-324**

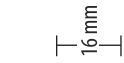
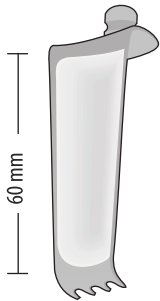

**WIS-BV-325**

CLOWARD Modif.  
**WIS-BV-319**  
Sperrer, allein  
Retractor, only  
Divaricatore, solo  
Separador, suelto  
Ecarteur, seul

CLOWARD modif.  
**WIS-BV-320**  
Komplett mit 5 valven  
Complete with 5 blades  
Completo di 5 valve  
Completo con 5 valvas  
Complect avec 5 valves

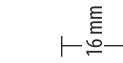
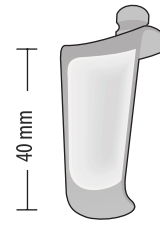

**WIS-BV-326**

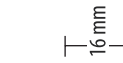
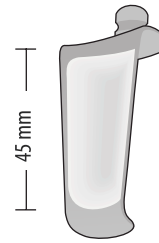

**WIS-BV-327**

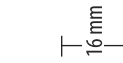
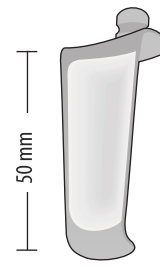

**WIS-BV-328**

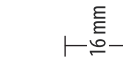
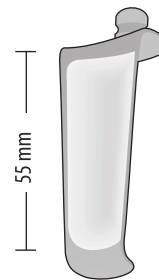

**WIS-BV-329**

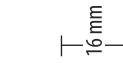
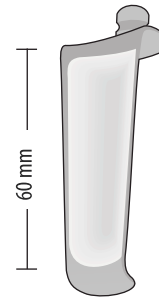

**WIS-BV-330**

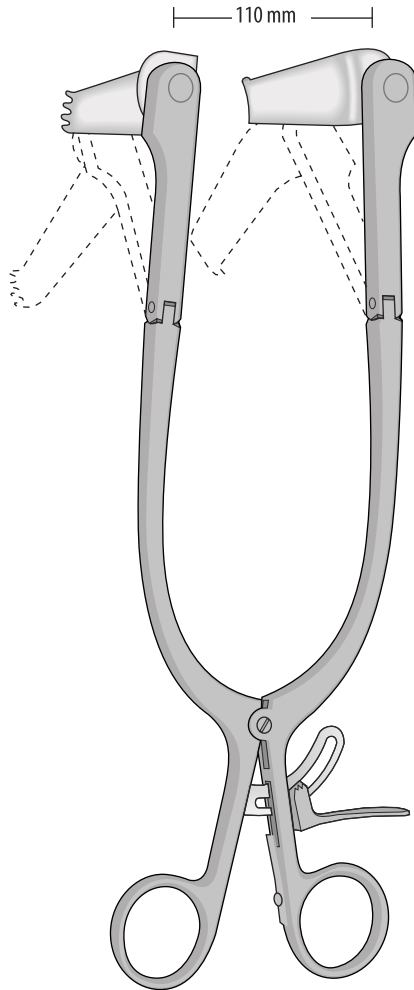

CLOWARD modif.  
**WIS-BV-320**  
250 mm

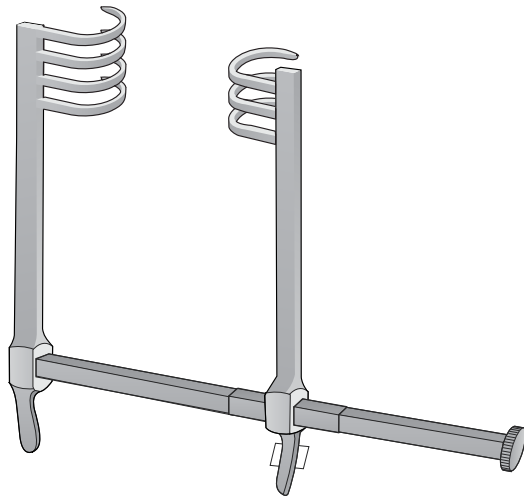

FRAZIER  
WIS-BV-35

Instrumente allein, ohne Blätter  
Frame only - Strumento solo, senza valve  
Cuadro solo - Cadre seul

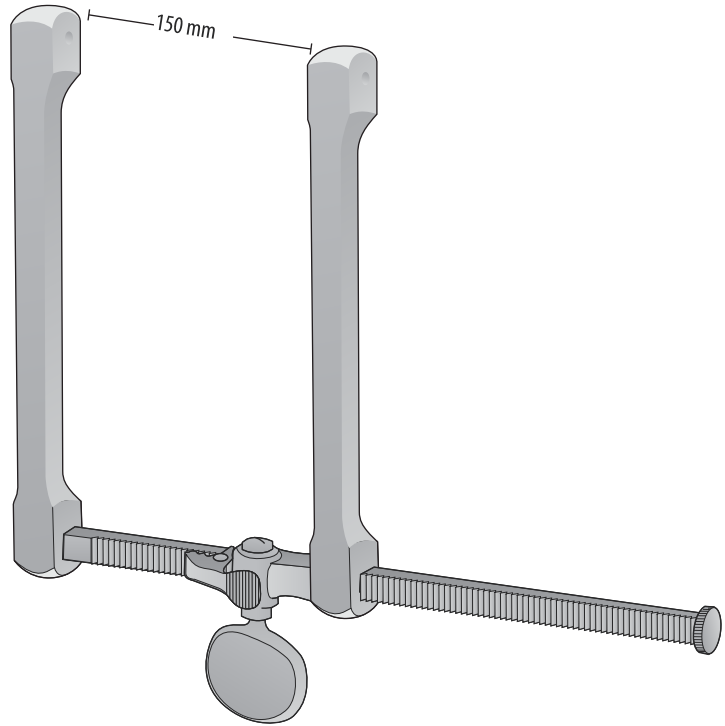

SCOVILLE  
WIS-BV-161

Instrumente allein, ohne Blätter  
Frame only  
Strumento solo, senza valve  
Cuadro solo  
Cadre seul

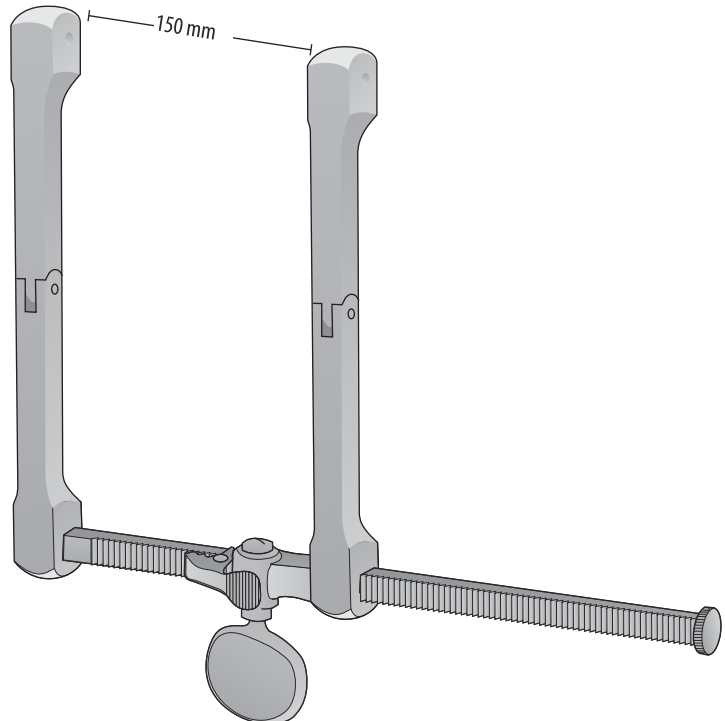

SCOVILLE-HAVERFIELD  
WIS-BV-160



Spitz  
Scharp  
Acuto  
Agudo  
Point?

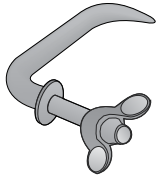

SCOVILLE  
**WIS-BV-163**  
50 mm

Spitz  
Scharp  
Acuto  
Agudo  
Point?

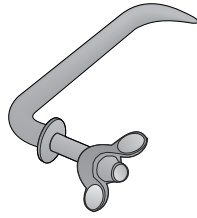

SCOVILLE  
**WIS-BV-164**  
70 mm

Stumpf  
Blunt  
Smusso  
Romo  
Mousse

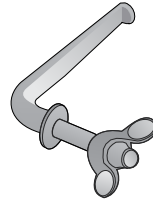

SCOVILLE  
**WIS-BV-165**  
50 mm

Stumpf  
Blunt  
Smusso  
Romo  
Mousse

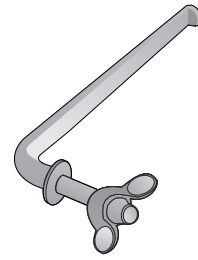

SCOVILLE  
**WIS-BV-166**  
70 mm

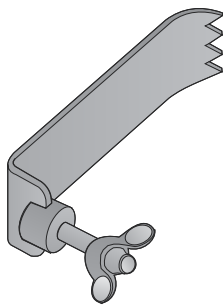

SCOVILLE  
**WIS-BV-167** 50x25 mm  
**WIS-BV-168** 50x50 mm  
**WIS-BV-169** 57x38 mm  
**WIS-BV-170** 64x25 mm  
**WIS-BV-171** 64x50 mm  
**WIS-BV-172** 67x30 mm  
**WIS-BV-173** 75x25 mm  
**WIS-BV-174** 75x50 mm  
**WIS-BV-175** 88x25 mm  
**WIS-BV-176** 100x50 mm

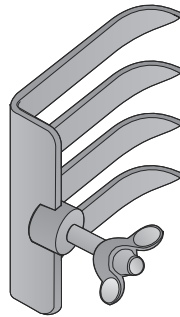

TAYLOR  
**WIS-BV-177** 48x50 mm  
**WIS-BV-178** 64x50 mm  
**WIS-BV-179** 64x64 mm  
**WIS-BV-180** 80x57 mm

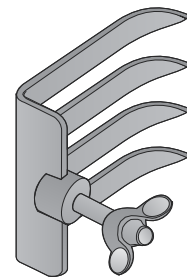

SCOVILLE  
**WIS-BV-181** 41x38 mm  
**WIS-BV-182** 67x44 mm

**WAAWAAORTHO**  
INDUSTRY  
**Sialkot Pakistan**

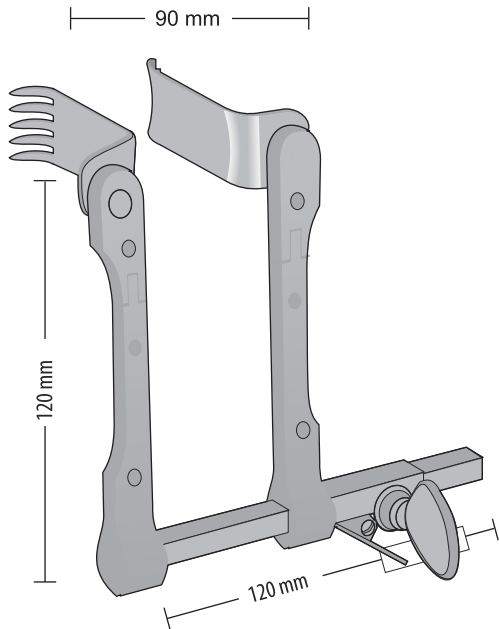

CASPAR  
**WIS-BV-250**  
Komplett mit 5 + 5 Blätter  
Complete with 5 + 5 blade  
Completo con 5 + 5 valve  
Completo con 5 + 5 valvas  
Complet avec 5 + 5 valves

**WIS-BV-249**  
Sperrer allein  
Retractor only  
Divaricatore solo  
Separador suelto  
Ecarteur seul

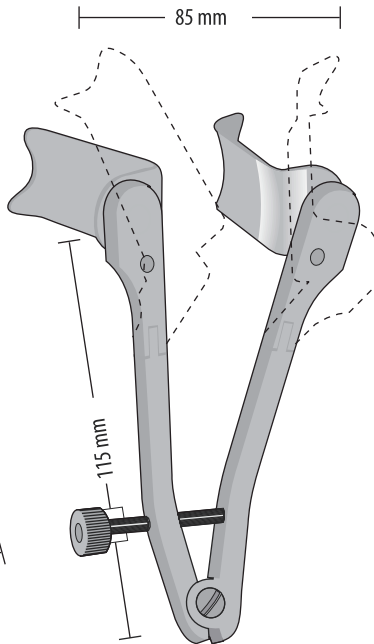

CASPAR  
**WIS-BV-270**  
Komplett mit 5 Blätter  
Complete with 5 blade  
Completo con 5 valve  
Completo con 5 valvas  
Complet avec 5 valves

**WIS-BV-269**  
Sperrer allein  
Retractor only  
Divaricatore solo  
Separador suelto  
Ecarteur seul

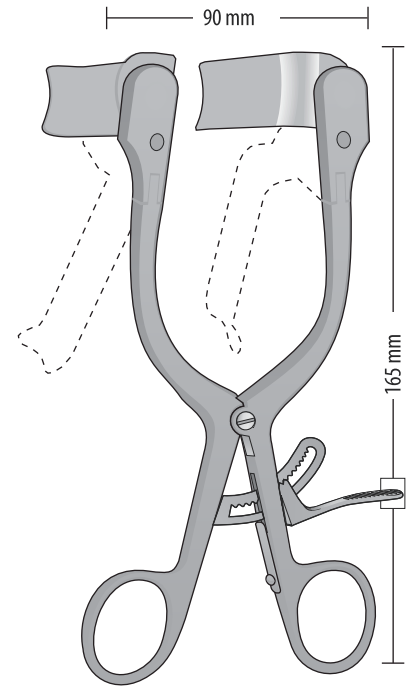

CASPAR  
**WIS-BV-280**  
Komplett mit 5 Blätter  
Complete with 5 blade  
Completo con 5 valve  
Completo con 5 valvas  
Complet avec 5 valves

**WIS-BV-279**  
Sperrer allein  
Retractor only  
Divaricatore solo  
Separador suelto  
Ecarteur seul

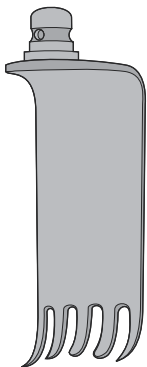

**WIS-BV-251**  
40 x 23 mm  
**WIS-BV-252**  
45 x 23 mm  
**WIS-BV-253**  
50 x 23 mm  
**WIS-BV-254**  
55 x 23 mm  
**WIS-BV-255**  
60 x 23 mm

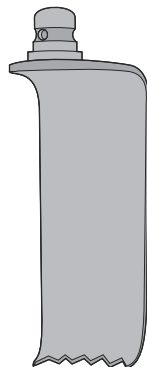

**WIS-BV-256**  
40 x 23 mm  
**WIS-BV-257**  
45 x 23 mm  
**WIS-BV-258**  
50 x 23 mm  
**WIS-BV-259**  
55 x 23 mm  
**WIS-BV-260**  
60 x 23 mm



**WIS-BV-271**  
45 x 23 mm  
**WIS-BV-272**  
50 x 23 mm  
**WIS-BV-273**  
55 x 23 mm  
**WIS-BV-274**  
60 x 23 mm  
**WIS-BV-275**  
65 x 23 mm

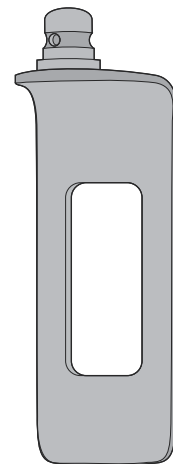

**WIS-BV-276**  
50 x 25 mm  
**WIS-BV-277**  
60 x 25 mm

Titan-valven  
Titanium blades  
Valve in titanio  
Valvas in titanio  
Valves en titane

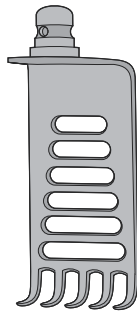

**WIS-BV-281 T** 25 x 24 mm  
**WIS-BV-282 T** 30 x 24 mm  
**WIS-BV-283 T** 35 x 24 mm  
**WIS-BV-284 T** 40 x 24 mm  
**WIS-BV-285 T** 45 x 24 mm  
**WIS-BV-286 T** 25 x 24 mm  
**WIS-BV-287 T** 30 x 24 mm  
**WIS-BV-288 T** 35 x 24 mm  
**WIS-BV-289 T** 40 x 24 mm  
**WIS-BV-290 T** 45 x 24 mm

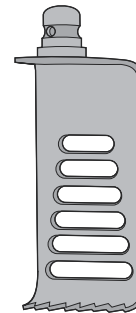

**WIS-BV-291 T** 25 x 24 mm  
**WIS-BV-292 T** 30 x 24 mm  
**WIS-BV-293 T** 35 x 24 mm  
**WIS-BV-294 T** 40 x 24 mm  
**WIS-BV-295 T** 45 x 24 mm  
**WIS-BV-296 T** 50 x 24 mm  
**WIS-BV-297 T** 55 x 24 mm  
**WIS-BV-298 T** 60 x 24 mm  
**WIS-BV-299 T** 65 x 24 mm  
**WIS-BV-300 T** 70 x 24 mm

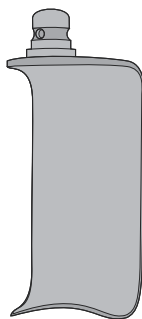

**WIS-BV-301 T** 30 x 24 mm  
**WIS-BV-302 T** 35 x 24 mm  
**WIS-BV-303 T** 40 x 24 mm  
**WIS-BV-304 T** 45 x 24 mm  
**WIS-BV-305 T** 50 x 24 mm  
**WIS-BV-306 T** 55 x 24 mm  
**WIS-BV-307 T** 60 x 24 mm  
**WIS-BV-308 T** 65 x 24 mm  
**WIS-BV-309 T** 70 x 24 mm  
**WIS-BV-310 T** 75 x 24 mm

Pinzette zum wechseln der valven  
mit kugelschnellverschluss  
Blade ejector for changing the blades  
with ball snap closure  
Pinzetta per la sostituzione delle valve  
con i bloccaggi rapidi a sfera  
Pinces pour changer les valves munies  
du syst?me de verrouillage rapide ? billes

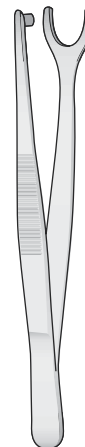

**WIS-BV-229**  
115 mm

Oberfläche schwarz beschichtet  
Surface black-coated

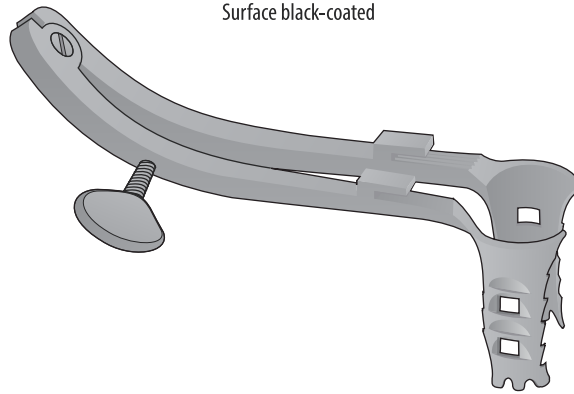

CASPAR  
WIS-BV-201/WIS-BV-208

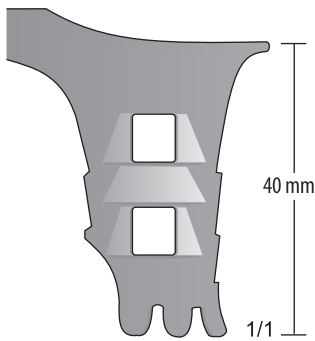

WIS-BV-201

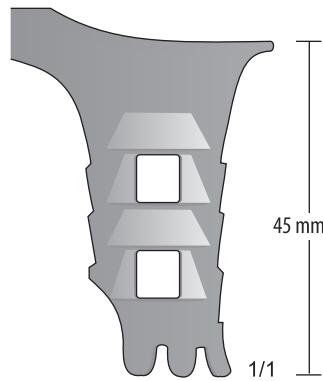

WIS-BV-202

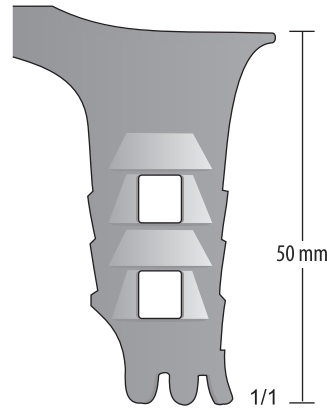

WIS-BV-203

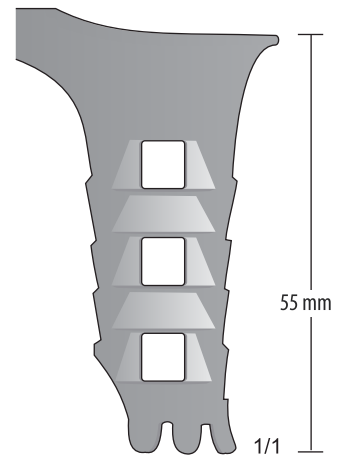

WIS-BV-204

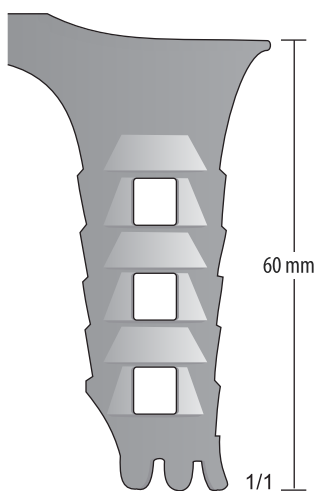

WIS-BV-205

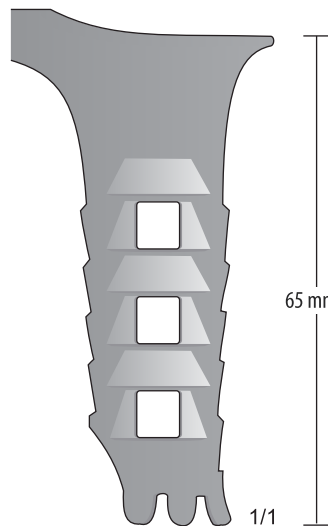

WIS-BV-206

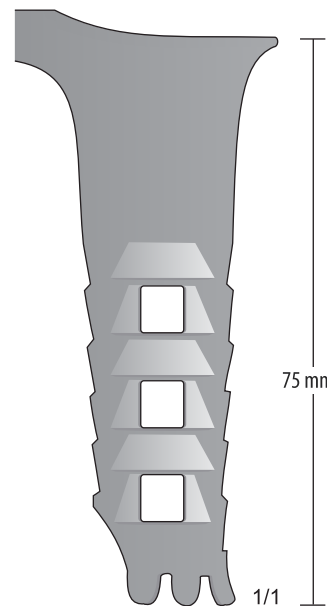

WIS-BV-207

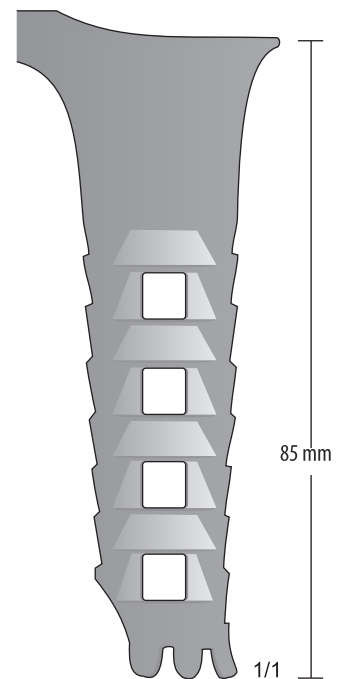

WIS-BV-208

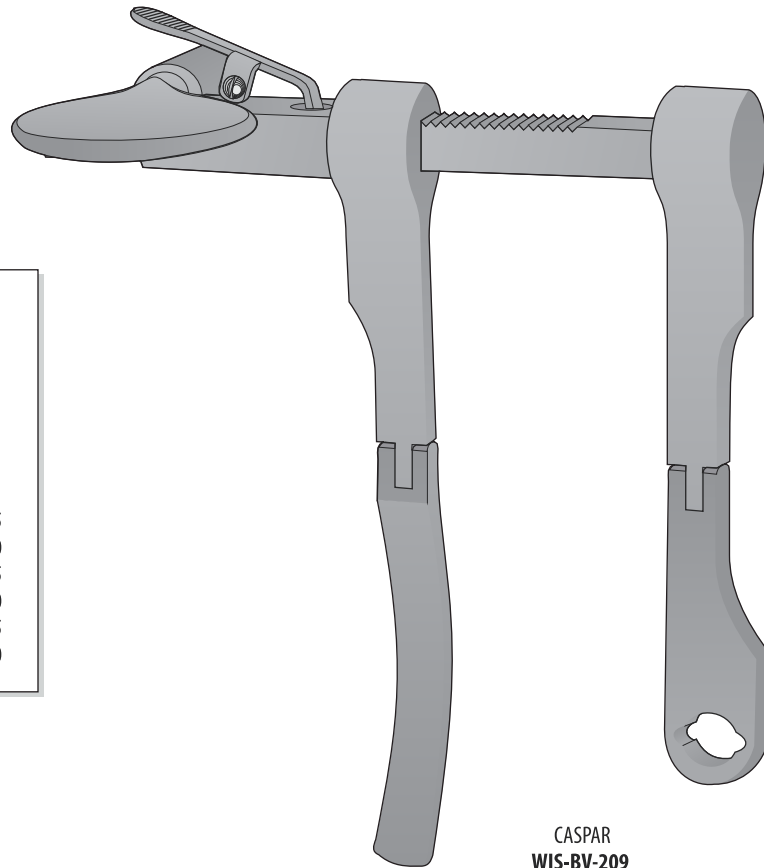

CASPAR  
**WIS-BV-210**

Sperrer komplett mit  
Retractor complete with  
Divaricatore completo di  
Separador completo con  
Écarteur complet avec

<b>WIS-BV-211</b>	Valva anti-ri?esso mm. 35
<b>WIS-BV-212</b>	Valva anti-ri?esso mm. 40
<b>WIS-BV-213</b>	Valva anti-ri?esso mm. 45
<b>WIS-BV-214</b>	Valva anti-ri?esso mm. 50
<b>WIS-BV-215</b>	Valva anti-ri?esso mm. 55
<b>WIS-BV-216</b>	Valva anti-ri?esso mm. 60

**WIS-BV-209**

Sperrer allein  
Retractor only  
Divaricatore solo  
Separador suelto  
Écarteur seul

CASPAR  
**WIS-BV-209**

Ober?che schwarz Beschichtet  
Surface Black-coated  
Valve anti-ri?esso  
Surface noircie

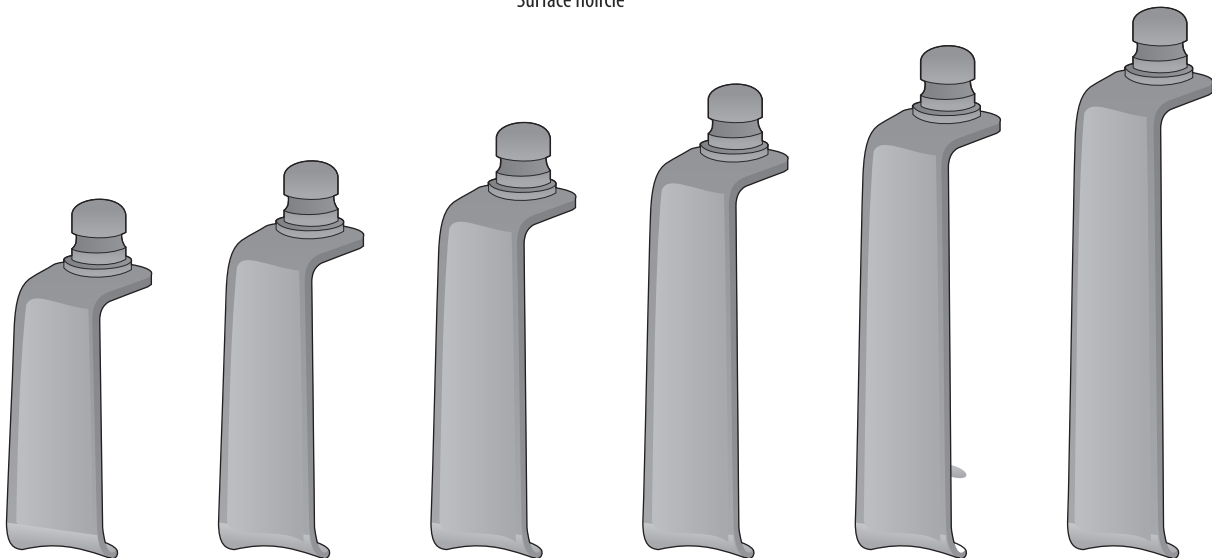

**WIS-BV-211**  
35 mm

**WIS-BV-212**  
40 mm

**WIS-BV-213**  
45 mm

**WIS-BV-214**  
50 mm

**WIS-BV-215**  
55 mm

**WIS-BV-216**  
60 mm

CASPAR

**WIS-FF-190**

Distraktor komplett rechts

Distractor complete right

Distrattore completo destro

**WIS-FF-191** 1 Distraktor allein - 1 Distractor only

**WIS-FF-192** 1 Bohrb?chse - 1 Drilling Guide

**WIS-FF-203** 1 Spezialbohrer - 1 Special Drill

**WIS-FF-205** 2 Distraktionsschrauben - 2 Distraction Screws

**WIS-FF-206** 1 Schraubendreher - 1 Screw Driver

**WAA**WAA**ORTHO**  
INDUSTRY  
Sialkot Pakistan

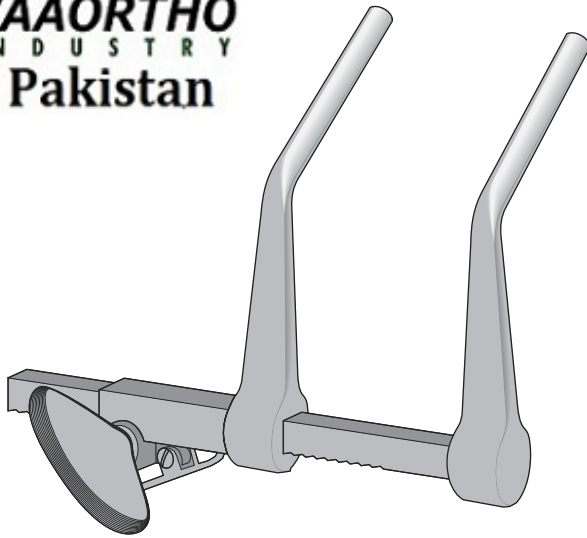

CASPAR  
**WIS-FF-191**  
Distrattore destro, solo

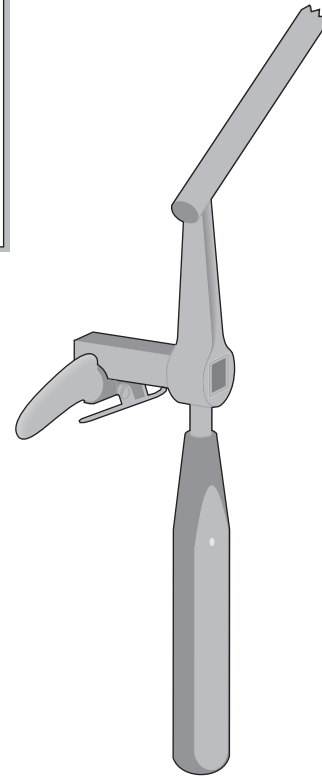

**WIS-FF-192**  
Guida punte destro, solo

CASPAR

**WIS-FF-200**

Distraktor komplett links

Distractor complete left

Distrattore completo sinistro

**WIS-FF-201** 1 Distraktor allein - 1 Distractor only

**WIS-FF-202** 1 Bohrb?chse - 1 Drilling Guide

**WIS-FF-203** 1 Spezialbohrer - 1 Special Drill

**WIS-FF-205** 2 Distraktionsschrauben - 2 Distraction Screws

**WIS-FF-206** 1 Schraubendreher - 1 Screw Driver

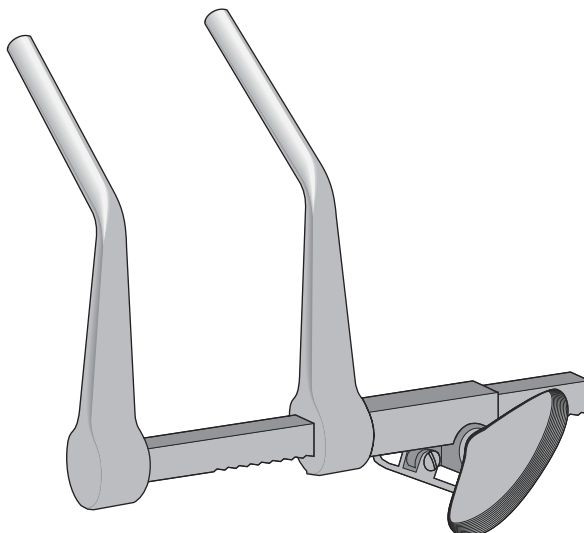

CASPAR  
**WIS-FF-201**  
Distrattore sinistro, solo

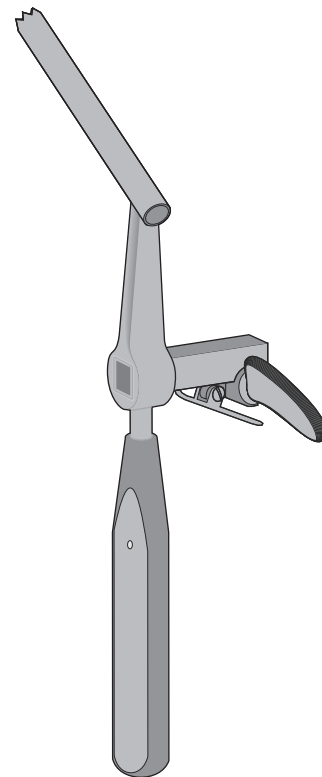

**WIS-FF-202**  
Guida punte sinistro, solo

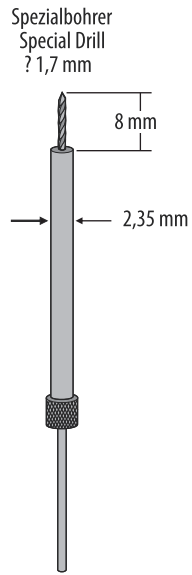

CASPAR  
**WIS-FF-203**  
145 mm

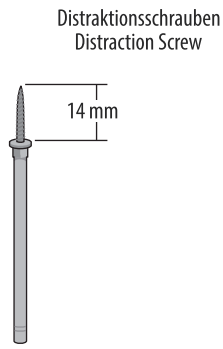

CASPAR  
**WIS-FF-204**  
70 mm

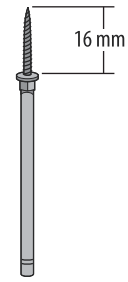

CASPAR  
**WIS-FF-205**  
70 mm

Schraubendreher  
Screw Driver

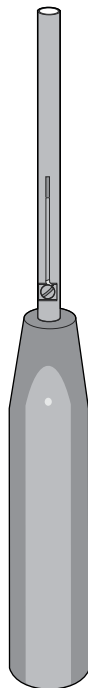

CASPAR  
**WIS-FF-206**  
200 mm

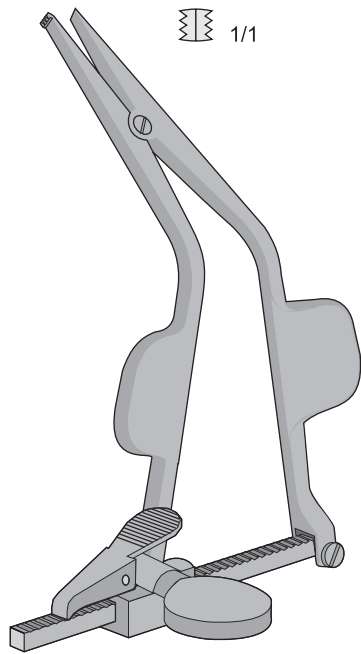

CLOWARD  
**WIS-BV-86**  
150 mm

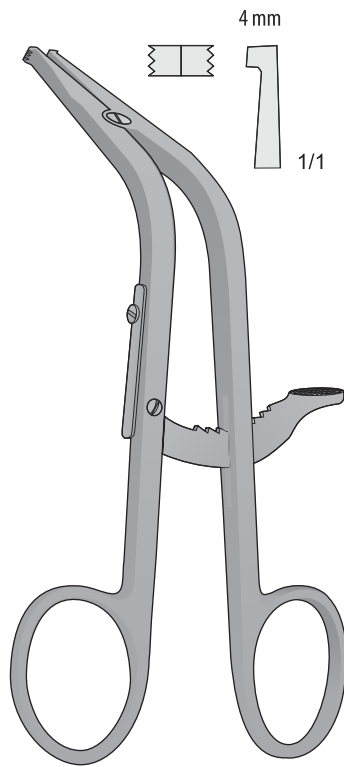

CLOWARD  
**WIS-BV-84**  
160 mm

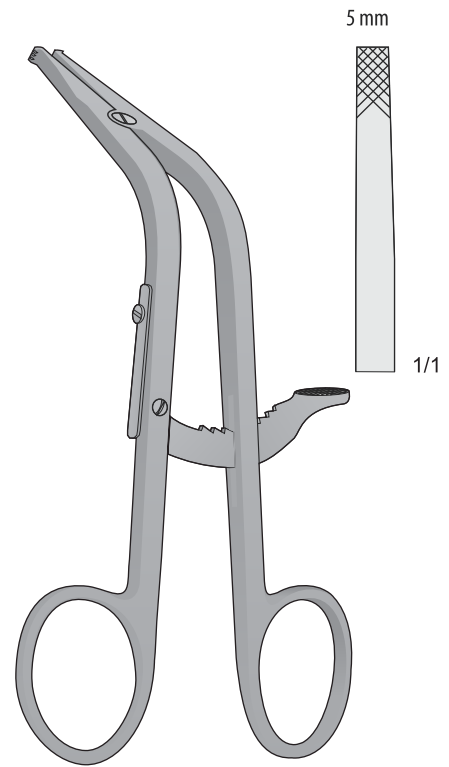

CLOWARD  
**WIS-BV-85**  
160 mm

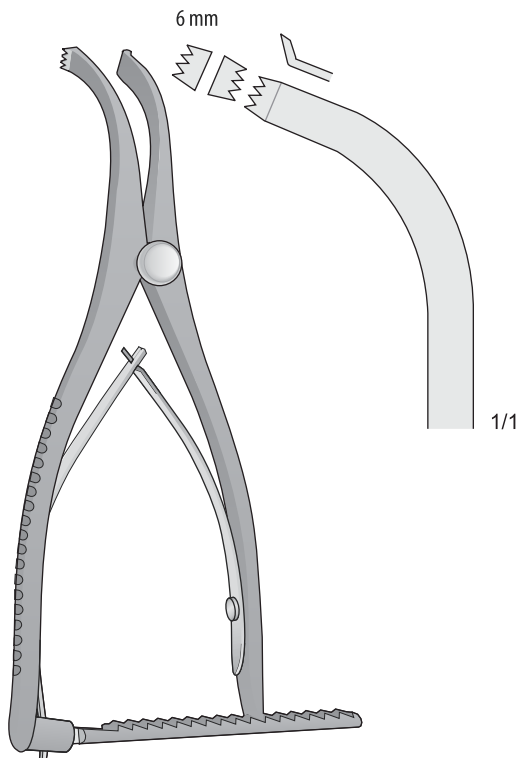

INGE  
**WIS-BV-80**  
160 mm

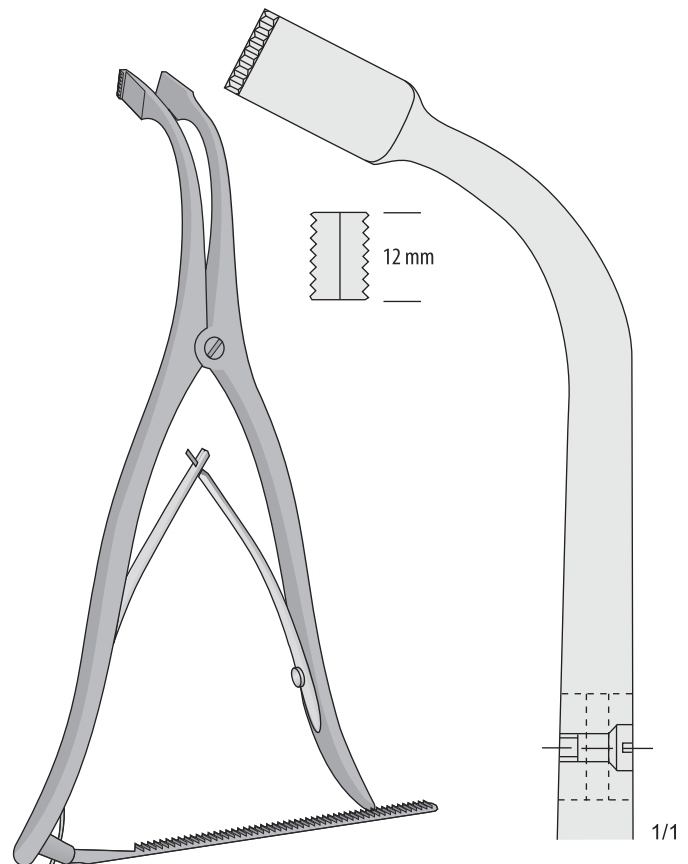

INGE  
**WIS-BV-82**  
275 mm



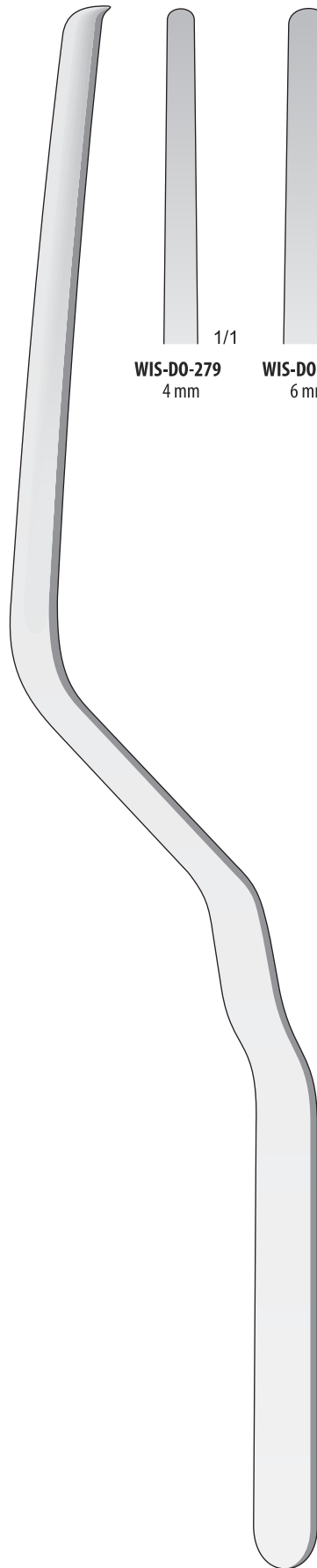

**WIS-DO-279/WIS-DO-282**  
240 mm

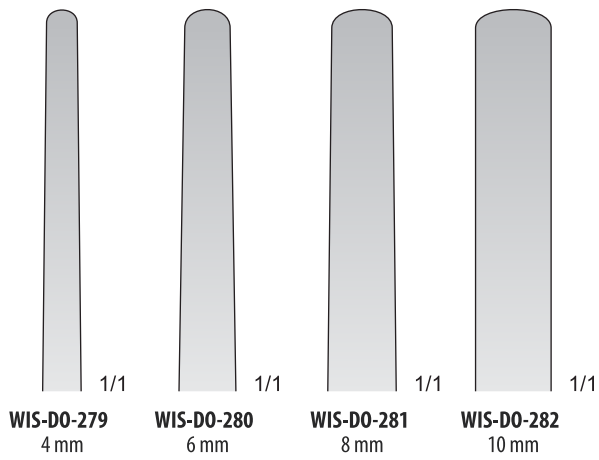

**WIS-DO-279** 4 mm 1/1  
**WIS-DO-280** 6 mm 1/1  
**WIS-DO-281** 8 mm 1/1  
**WIS-DO-282** 10 mm 1/1

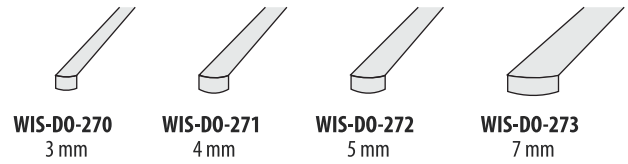

**WIS-DO-270** 3 mm  
**WIS-DO-271** 4 mm  
**WIS-DO-272** 5 mm  
**WIS-DO-273** 7 mm

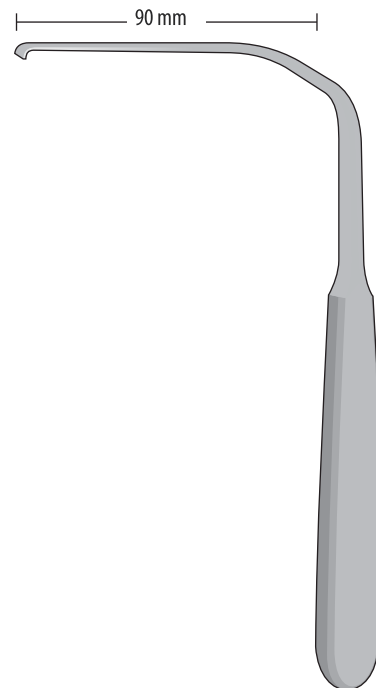

HESS  
**WIS-DO-270/WIS-DO-273**  
 175 mm



1/1  
**WIS-BT-300**



1/1  
**WIS-BT-301**



1/1  
**WIS-BT-302**



1/1  
**WIS-BT-303**



CASPAR  
**WIS-BT-300/WIS-BT-303**  
245 mm



WIS-FF-301/WIS-FD-308

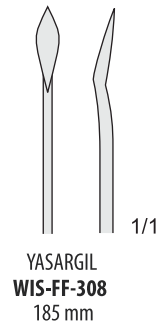
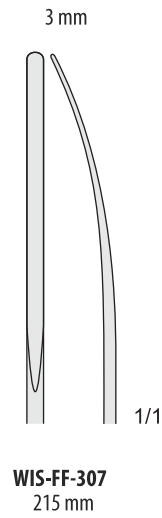
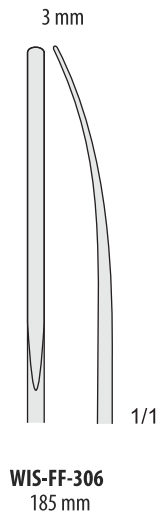
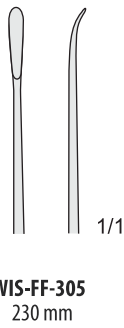
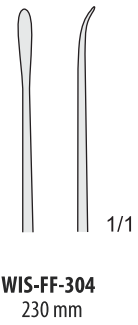
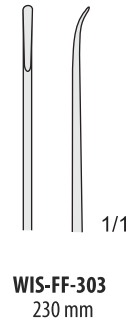
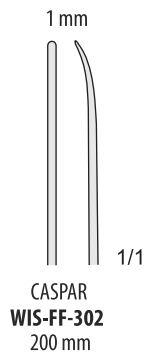
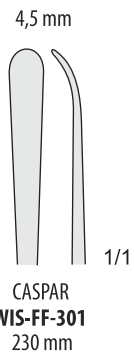

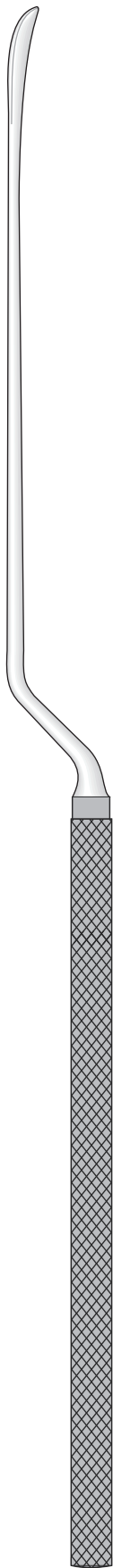

4,5 mm

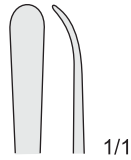

CASPAR  
**WIS-FF-309**  
230 mm

2 mm

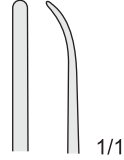

CASPAR  
**WIS-FF-310**  
230 mm

1 mm

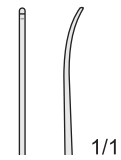

CASPAR  
**WIS-FF-311**  
210 mm

1 mm

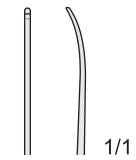

CASPAR  
**WIS-FF-312**  
210 mm

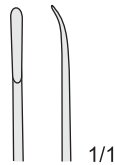

**WIS-FF-313**  
230 mm

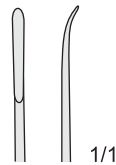

**WIS-FF-314**  
230 mm

WIS-FD-309/WIS-FD-314

Diritto



LOVE  
**WIS-DO-56**  
210 mm

45°

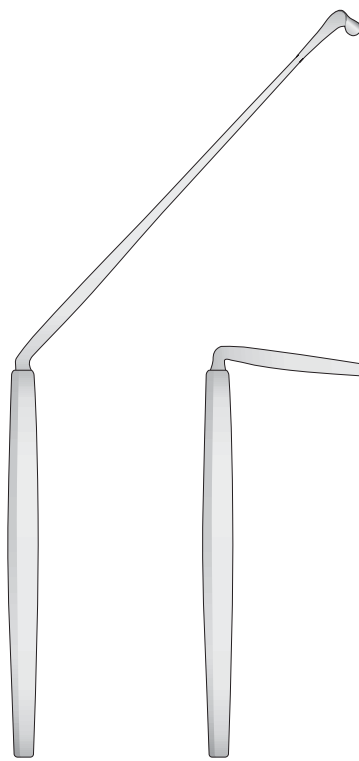

LOVE  
**WIS-DO-57**

90°

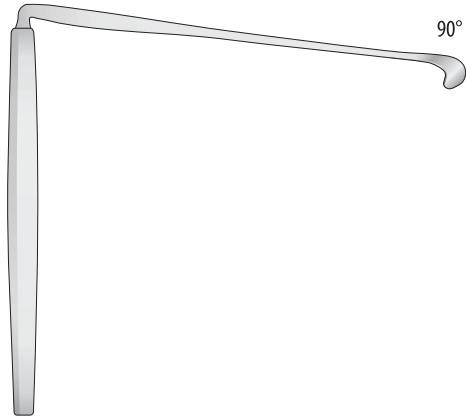

LOVE  
**WIS-DO-58**

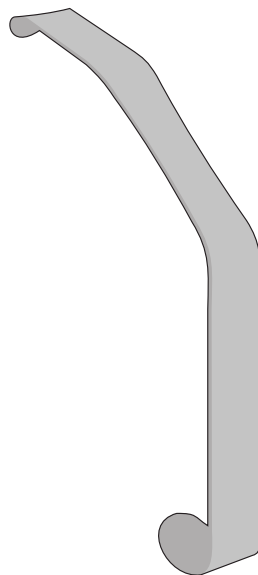

LOVE  
**WIS-DO-213** - 18 mm  
**WIS-DO-214** - 20 mm  
**WIS-DO-215** - 22 mm  
150 mm

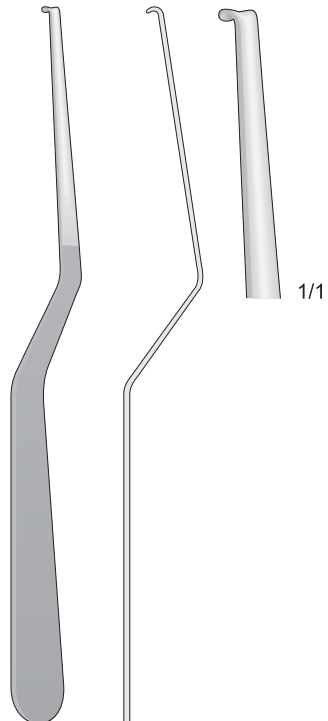

LOVE  
**WIS-DO-174**  
210 mm

**Suction Tubes**

Saugkanülen  
Canules d'aspiration  
Cánulas de aspiración  
Cannule per aspirazione

**Laminectomy**

Laminektomie  
Laminectomia  
Laminectomía  
Laminectomia

**Extension Bows**

Extensionsbügel  
Étriers d'extension  
Arcos de tracción  
Archi da trazione

**Knives**

Messer  
Couteaux  
Cuchillos  
Coltelli

**Bone Files**

Knochenfeilen  
Limes à os  
Limas para hueso  
Lime per osso

**Scalpel Blades and Handles**

Skalpellschneidmesser und Skalpellschneidmessergriffe  
Lames et manches de bistouris  
Hojas y mangos de bisturí  
Lame e manici per bisturi

Char. 6	= 2 mm
Char 7	= 2,5 mm
Char 8	= 2,7 mm
Char 9	= 3 mm
Char 10	= 3,3 mm
Char 12	= 4 mm
Char 15	= 5 mm

Isoliert



## FERGUSSON

<b>WIS-GF-140</b>	Ch. 6	2,0 mm
<b>WIS-GF-141</b>	Ch. 7	2,5 mm
<b>WIS-GF-142</b>	Ch. 9	3,0 mm
<b>WIS-GF-142B</b>	Ch. 10	3,3 mm
<b>WIS-GF-143</b>	Ch. 12	4,0 mm
<b>WIS-GF-144</b>	Ch. 15	5,0 mm
	180 mm	

## FRAZIER

<b>WIS-GF-240</b>	Ch. 6	2,0 mm
<b>WIS-GF-241</b>	Ch. 7	2,5 mm
<b>WIS-GF-241B</b>	Ch. 8	2,7 mm
<b>WIS-GF-242</b>	Ch. 9	3,0 mm
<b>WIS-GF-242B</b>	Ch. 10	3,3 mm
<b>WIS-GF-243</b>	Ch. 12	4,0 mm
<b>WIS-GF-244</b>	Ch. 15	5,0 mm
	180 mm	





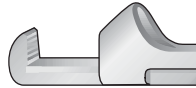

## FRAZIER

<b>WIS-GF-252</b>	Ch. 12	180 mm
-------------------	--------	--------

## PLESTER

<b>WIS-GF-150</b>	Ch. 6	2,0 mm
<b>WIS-GF-151</b>	Ch. 7	2,5 mm
<b>WIS-GF-151B</b>	Ch. 8	2,7 mm
<b>WIS-GF-152</b>	Ch. 9	3,0 mm
<b>WIS-GF-152B</b>	Ch. 10	3,3 mm
<b>WIS-GF-153</b>	Ch. 12	4,0 mm
<b>WIS-GF-154</b>	Ch. 15	5,0 mm
	200 mm	



1,5 mm  1/1 <b>WIS-DB-177</b>	2,0 mm  1/1 <b>WIS-DB-178</b>	2,2 mm  1/1 <b>WIS-DB-179</b>	2,5 mm  1/1 <b>WIS-DB-180</b>
3,0 mm  1/1 <b>WIS-DB-181</b>	3,5 mm  1/1 <b>WIS-DB-182</b>	4,0 mm  1/1 <b>WIS-DB-183</b>	

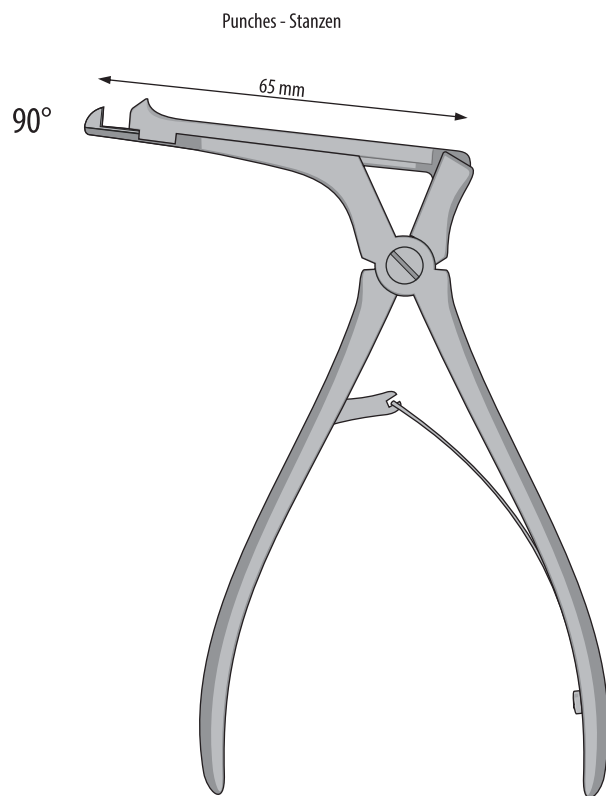

<b>WIS-DB-177</b>	1,5 mm
<b>WIS-DB-178</b>	2,0 mm
<b>WIS-DB-179</b>	2,2 mm
<b>WIS-DB-180</b>	2,5 mm
<b>WIS-DB-181</b>	3,0 mm
<b>WIS-DB-182</b>	3,5 mm
<b>WIS-DB-183</b>	4,0 mm

CITELLI  
**WIS-DB-177/WIS-DB-183**



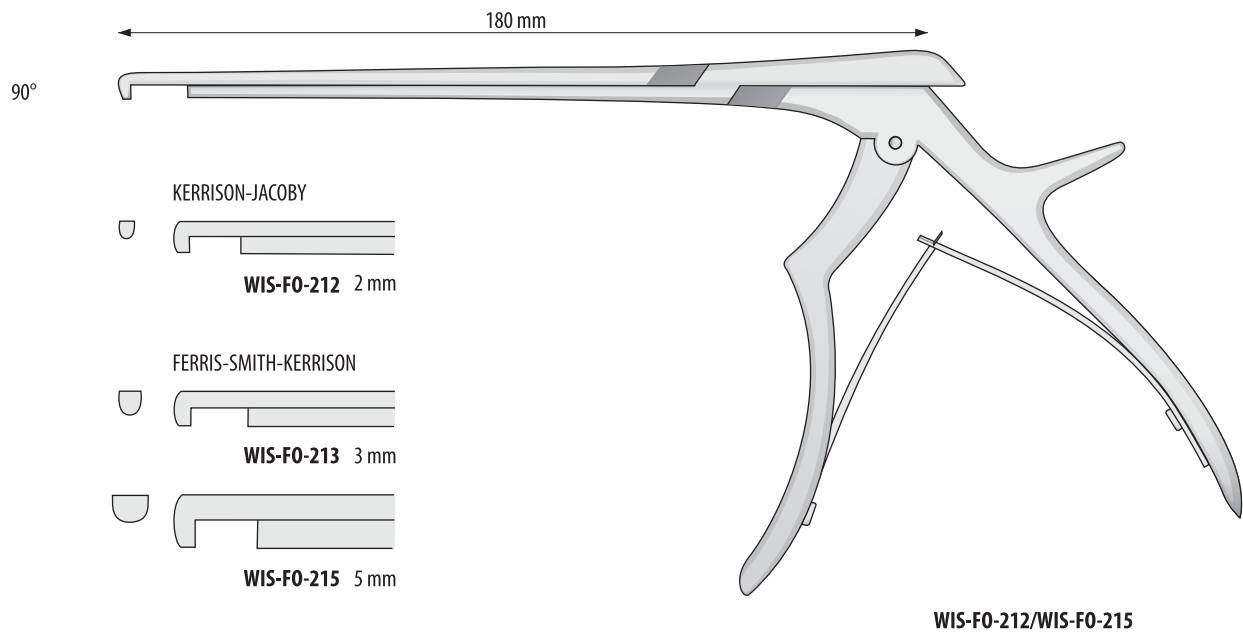
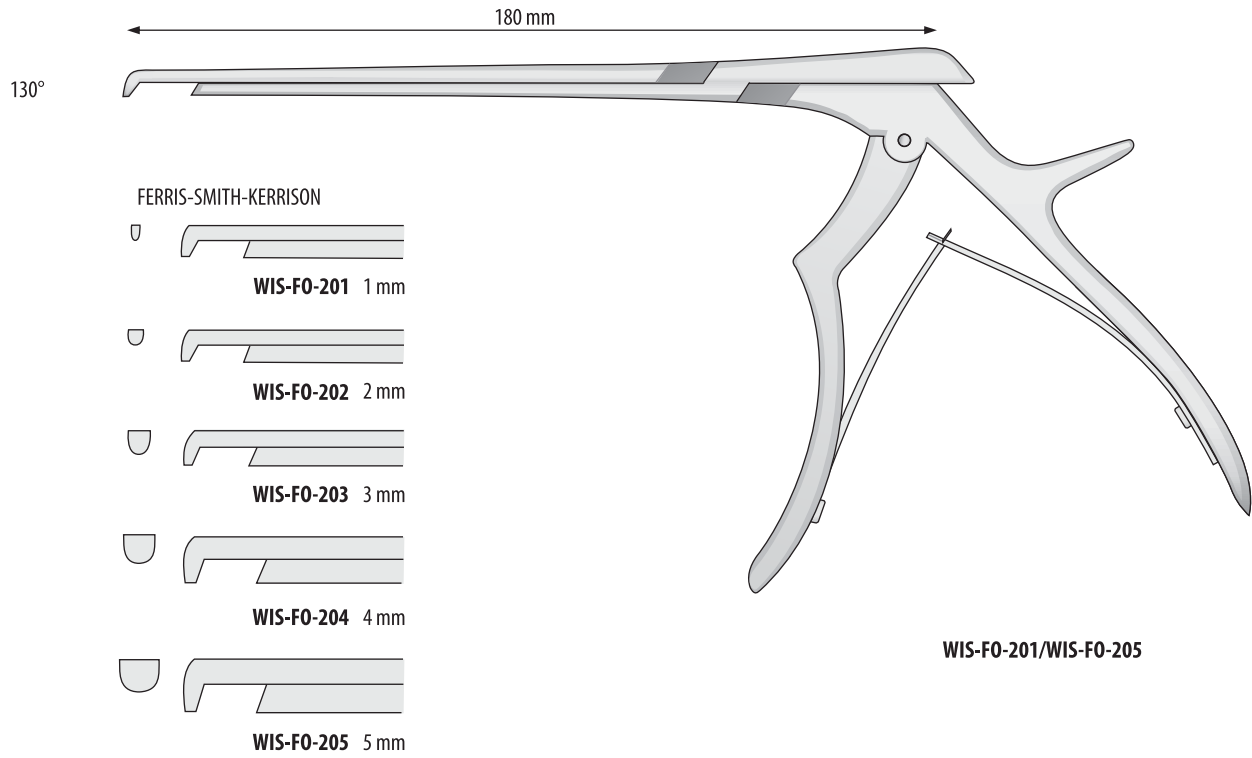

Punches - Stanzen

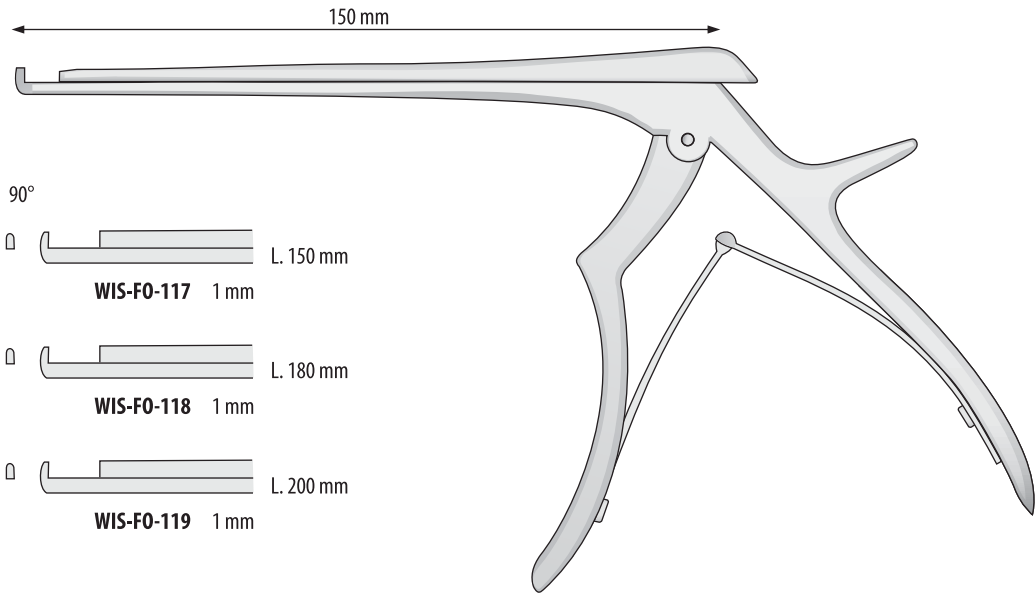

FERRIS-SMITH-KERRISON  
WIS-F0-117/WIS-F0-119

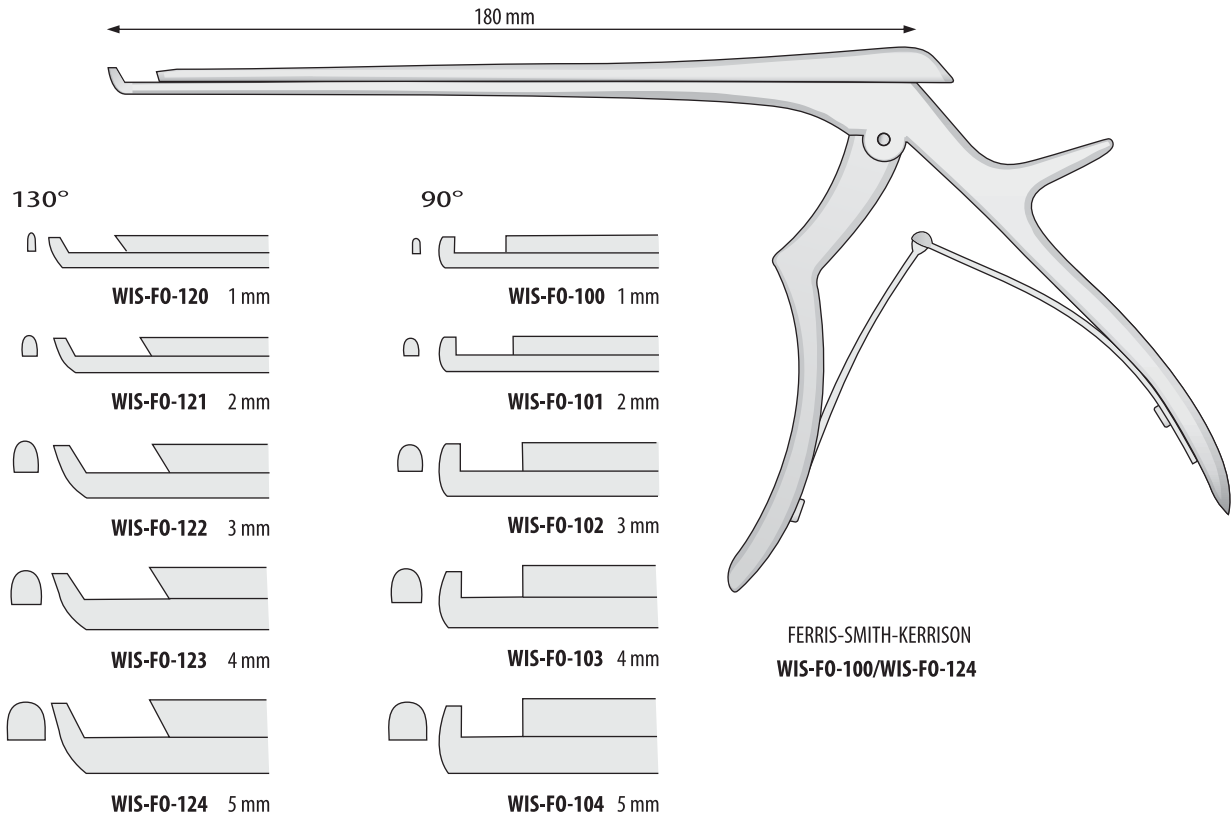

FERRIS-SMITH-KERRISON  
WIS-F0-100/WIS-F0-124

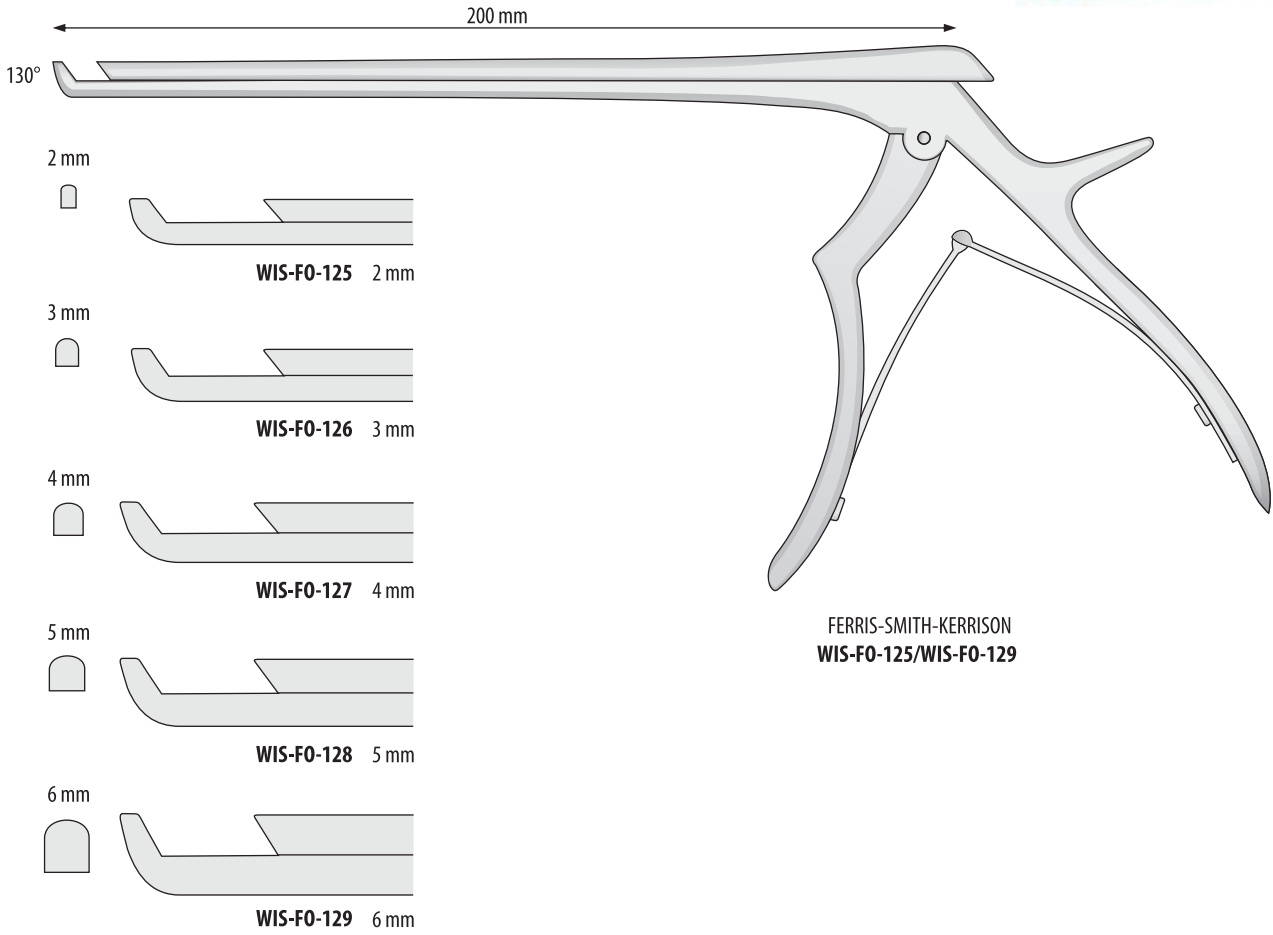

Laminotomo cervicale - Cervical Laminectomy

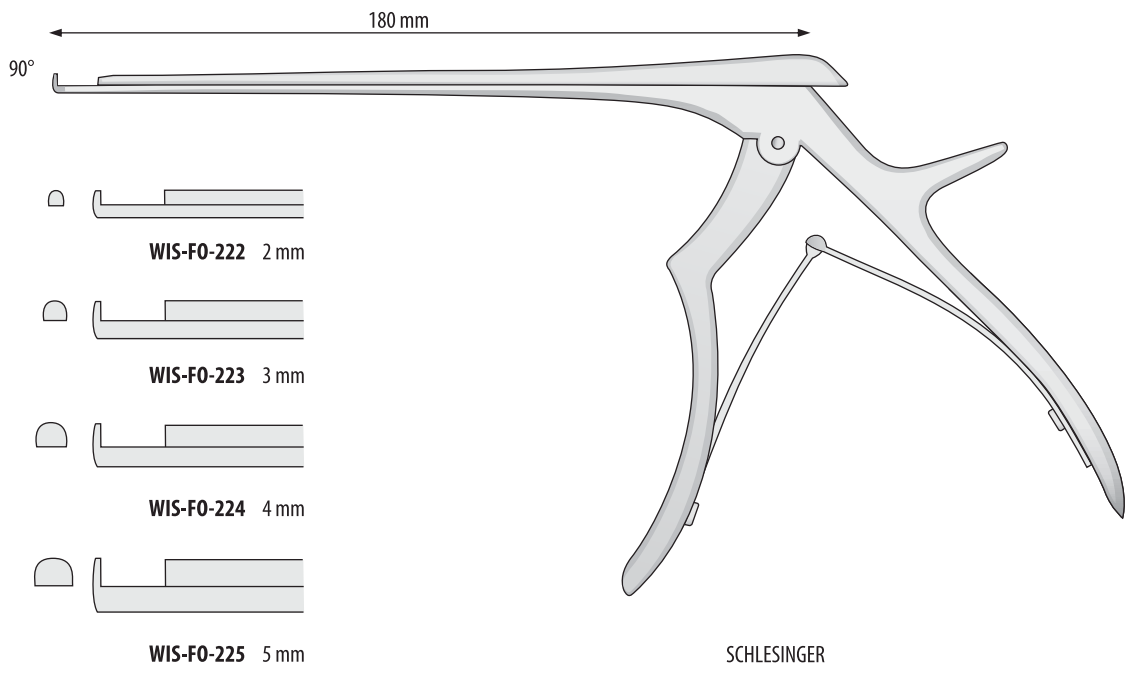

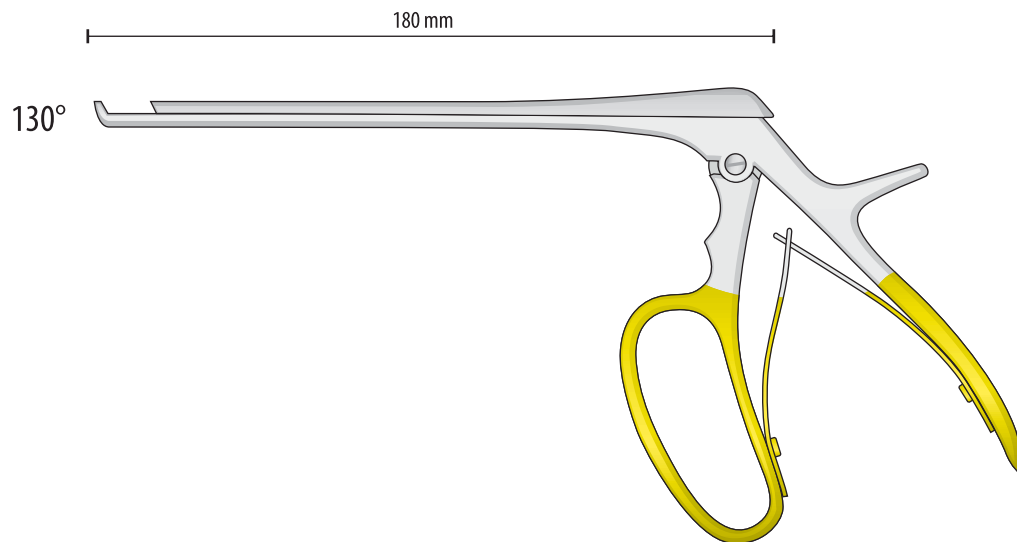
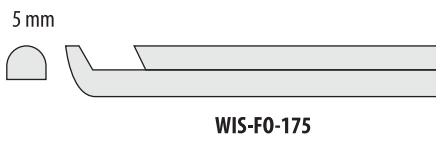
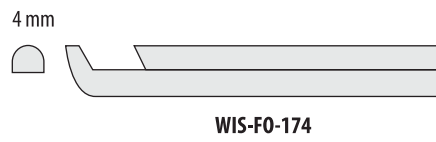
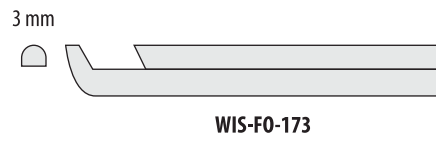
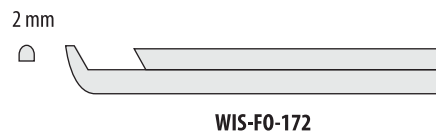

FERRIS - SMITH - KERRISON  
WIS-F0-171/WIS-F0-175

Gerade  
Straight  
Diritta  
Rectas  
Droites

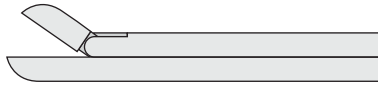

**WIS-FO-180** 2 x 10 mm

**WIS-FO-181** 3 x 10 mm

**WIS-FO-182** 4 x 10 mm

**WIS-FO-183** 6 x 12 mm

Aufw?rtsgebogen  
Top curved  
Curva verso l'alto  
Curvos  
Courbe vers le haut

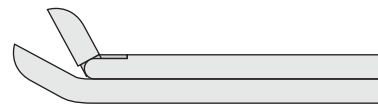

**WIS-FO-184** 2 x 10 mm

**WIS-FO-185** 3 x 10 mm

**WIS-FO-186** 4 x 10 mm

Abw?rts gebogen  
Bottom curved  
Curva verso il basso  
Curvos  
Courbe vers le bas

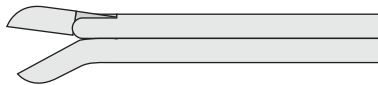

**WIS-FO-187** 2 x 10 mm

**WIS-FO-188** 3 x 10 mm

**WIS-FO-189** 4 x 10 mm

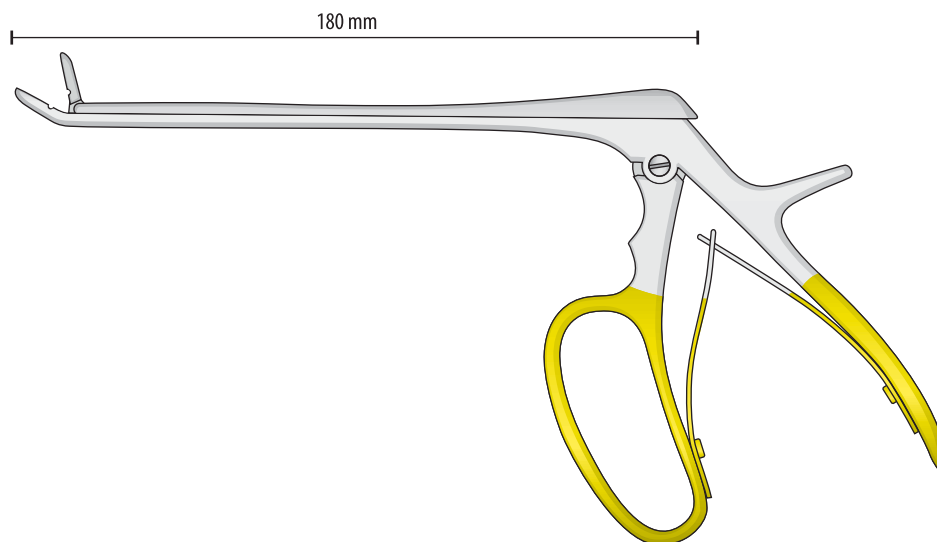

FERRIS - SMITH - CUSHING  
WIS-FO-180/WIS-FO-189

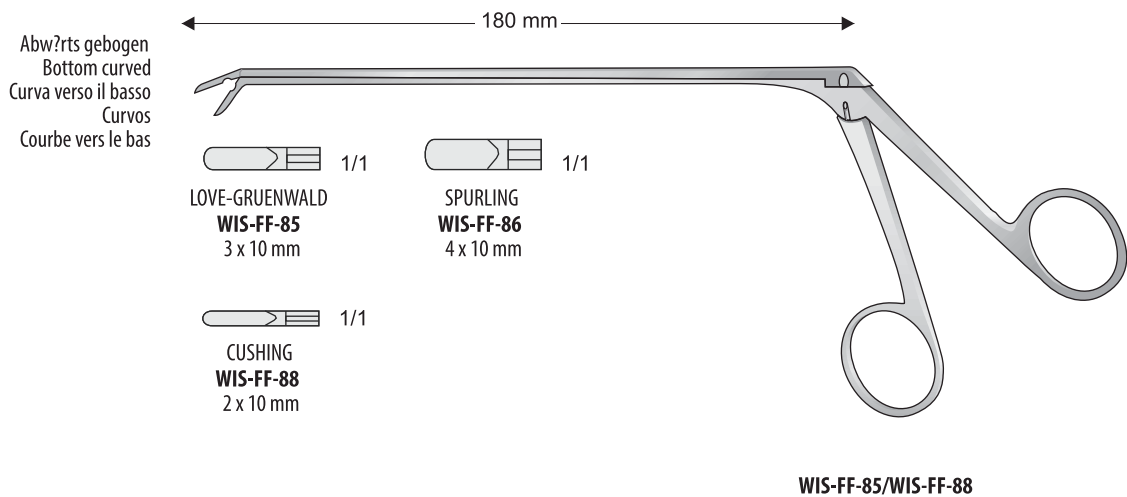
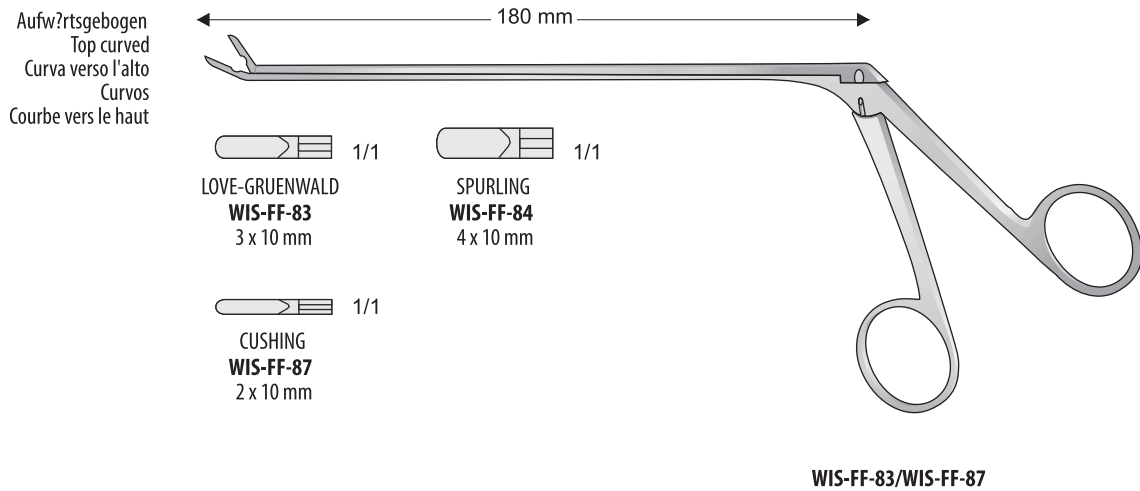
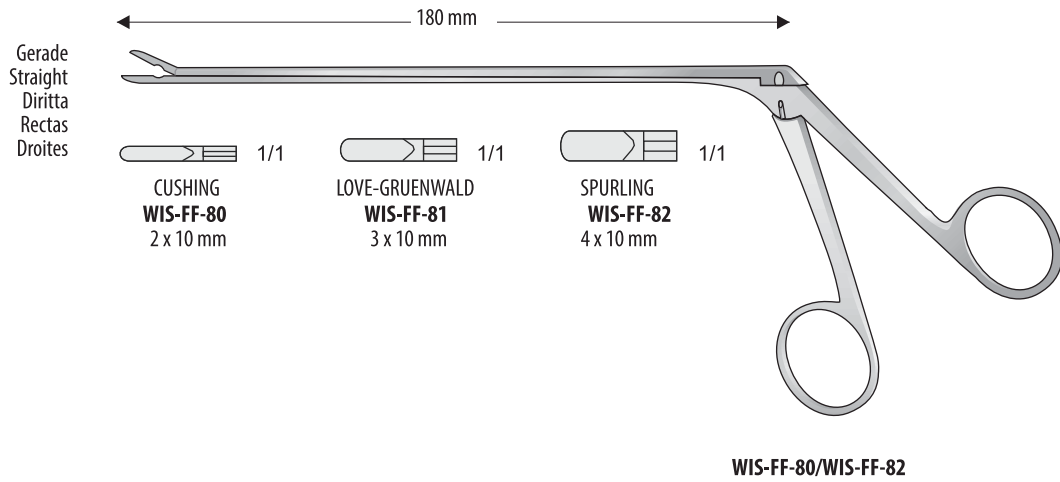

Gerade  
Straight  
Diritta  
Rectas  
Droites

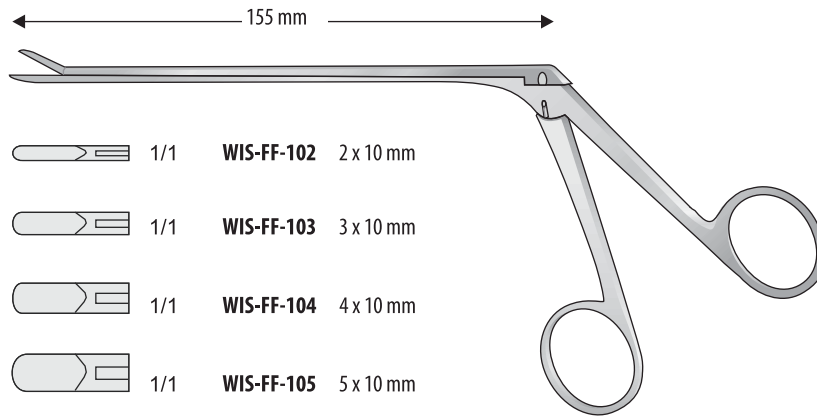

CASPAR  
WIS-FF-102/WIS-FF-105

Aufwärtsgebogen  
Top curved  
Curva verso l'alto  
Curvos  
Courbe vers le haut

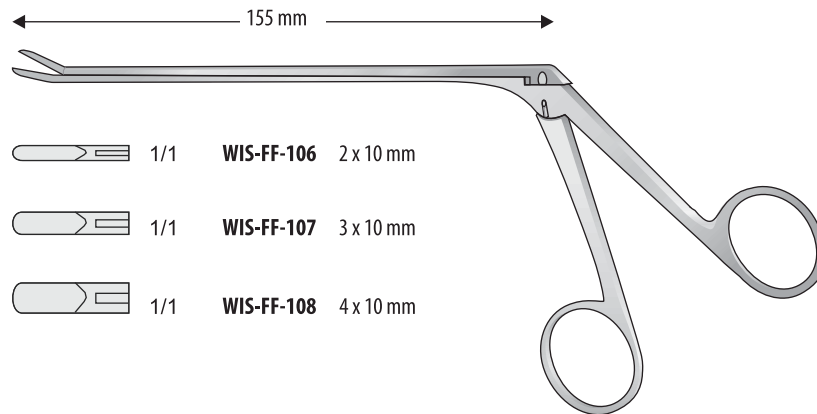

CASPAR  
WIS-FF-106/WIS-FF-108

Abwärts gebogen  
Bottom curved  
Curva verso il basso  
Curvos  
Courbe vers le bas

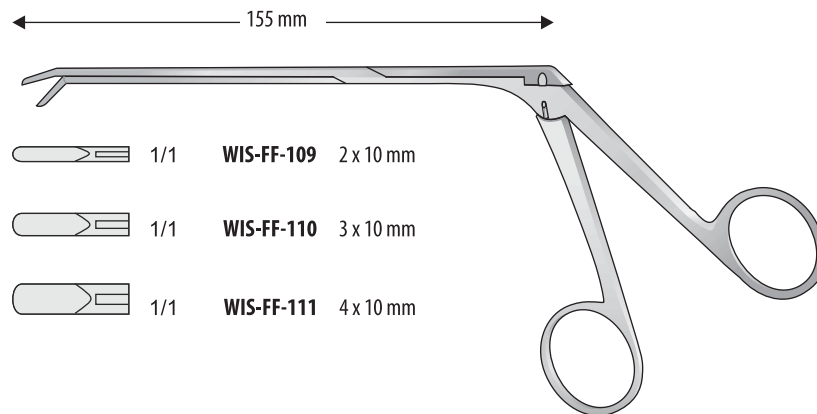



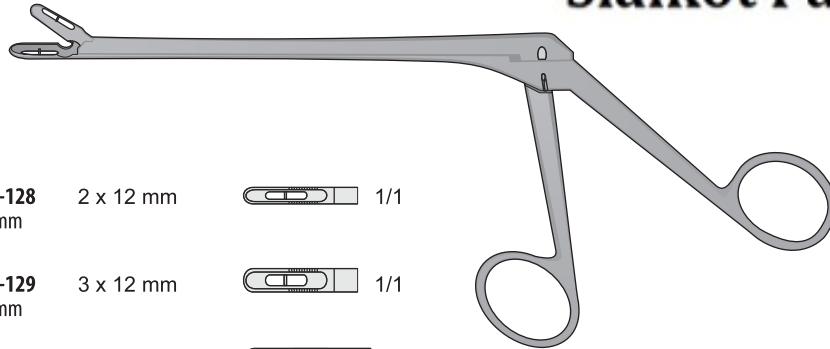

CASPAR  
WIS-FF-109/WIS-FF-111

Gerade  
Straight  
Diritta  
Rectas  
Droites



CASPAR



<b>WIS-FF-120</b> 140 mm	<b>WIS-FF-123</b> 160 mm	<b>WIS-FF-128</b> 185 mm	2 x 12 mm	 1/1
<b>WIS-FF-121</b> 140 mm	<b>WIS-FF-124</b> 160 mm	<b>WIS-FF-129</b> 185 mm	3 x 12 mm	 1/1
<b>WIS-FF-122</b> 140 mm	<b>WIS-FF-125</b> 160 mm	<b>WIS-FF-130</b> 185 mm	4 x 14 mm	 1/1
	<b>WIS-FF-126</b> 160 mm	<b>WIS-FF-131</b> 185 mm	5 x 14 mm	 1/1
	<b>WIS-FF-127</b> 160 mm	<b>WIS-FF-132</b> 185 mm	6 x 16 mm	 1/1

CASPAR  
WIS-FF-120/WIS-FF-132

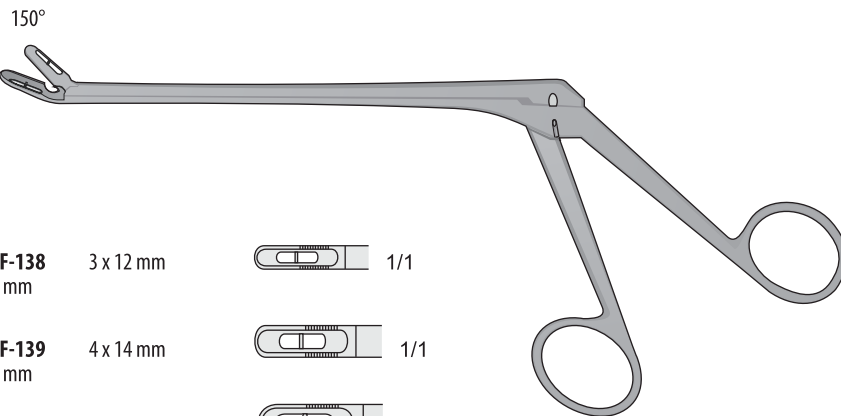
Aufw?rtsgebogen  
Top curved  
Curva verso l'alto  
Curvos  
Courbe vers le haut



CASPAR



<b>WIS-FF-133</b> 140 mm	<b>WIS-FF-135</b> 160 mm	<b>WIS-FF-138</b> 185 mm	3 x 12 mm	 1/1
<b>WIS-FF-134</b> 140 mm	<b>WIS-FF-136</b> 160 mm	<b>WIS-FF-139</b> 185 mm	4 x 14 mm	 1/1
	<b>WIS-FF-137</b> 160 mm	<b>WIS-FF-140</b> 185 mm	5 x 14 mm	 1/1

CASPAR  
WIS-FF-133/WIS-FF-140

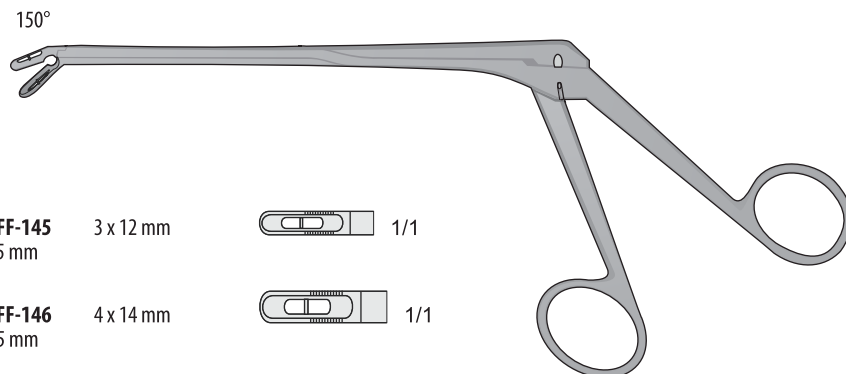
Abw?rts gebogen  
Bottom curved  
Curva verso il basso  
Curvos  
Courbe vers le bas

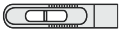

CASPAR

<b>WIS-FF-141</b> 140 mm	<b>WIS-FF-143</b> 160 mm	<b>WIS-FF-145</b> 185 mm	3 x 12 mm	 1/1
<b>WIS-FF-142</b> 140 mm	<b>WIS-FF-144</b> 160 mm	<b>WIS-FF-146</b> 185 mm	4 x 14 mm	 1/1

CASPAR  
WIS-FF-141/WIS-FF-146



Hohlmeißelzangen  
ür Laminektomie

Laminectomy  
Rongeurs

Pinze ossivore  
per laminectomia

Pinzas gubias  
para laminectomía

Pinces-gouges  
pour laminectomie

**WAAORTH**  
INDUSTRY  
**Sialkot Pakistan**

Gerade  
Straight  
Diritta  
Rectas  
Droites

← 210 mm →

1/1  
5,5 mm

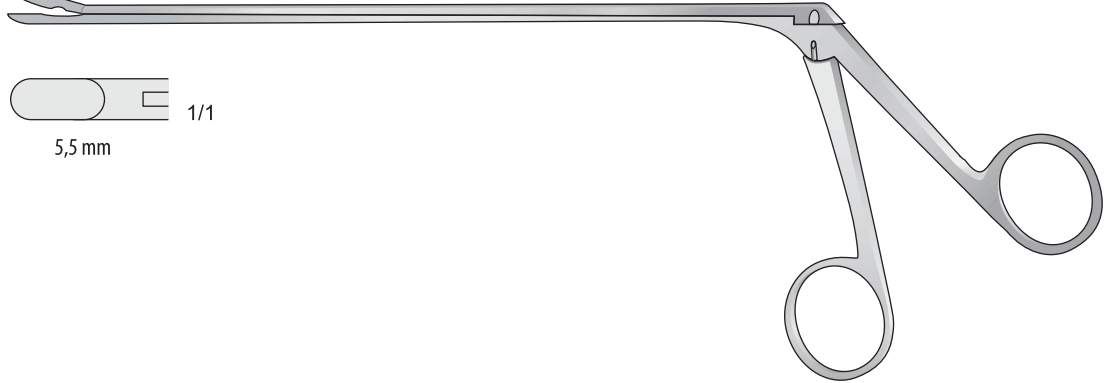

WAGNER  
WIS-FF-90

Gerade  
Straight  
Diritta  
Rectas  
Droites

← 255 mm →

1/1  
5,3 mm

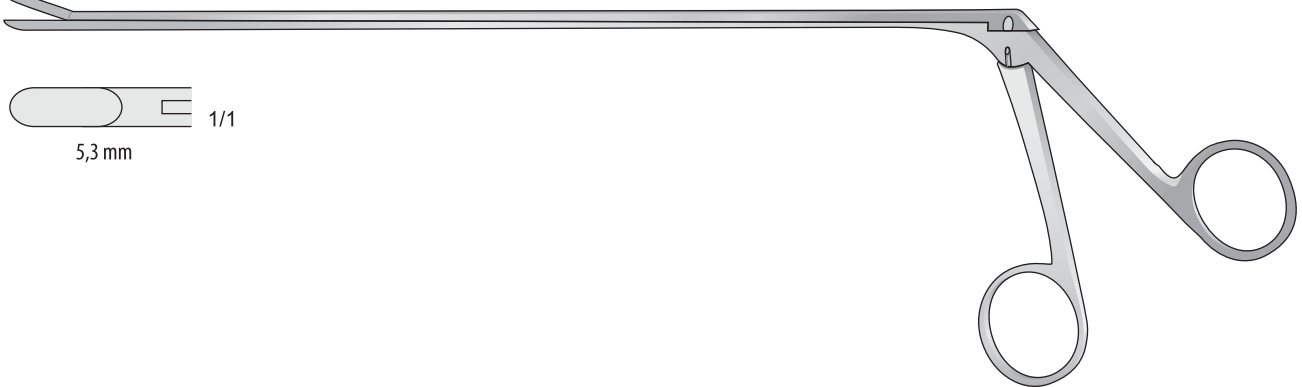

WIS-FF-91

Aufw?rtsgebogen  
Top curved  
Curva verso l'alto  
Curvos  
Courbe vers le haut

← 255 mm →

1/1  
5,8 mm

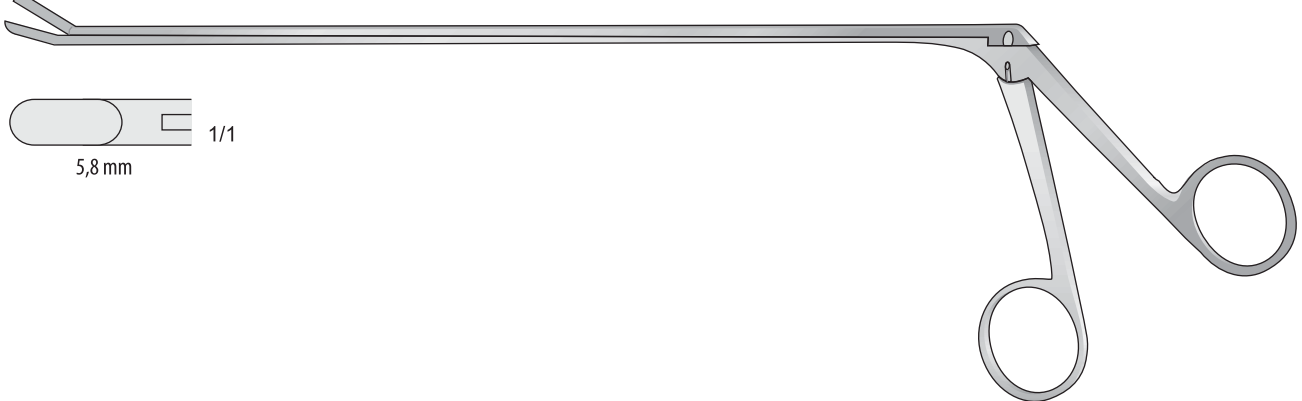

SYPERT  
WIS-FF-92

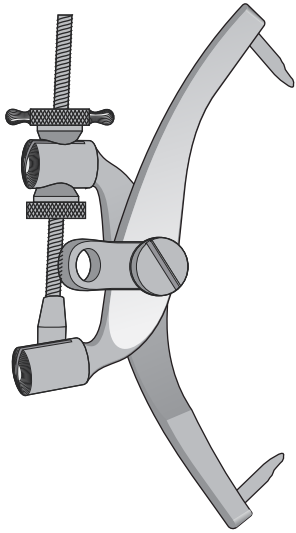

CRUTCHFIELD  
WIS-FF-394

Drill points only  
Vorbohrer dazu

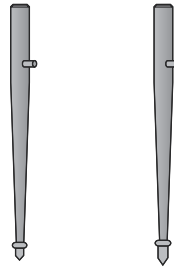

WIS-FF-395

WIS-FF-396

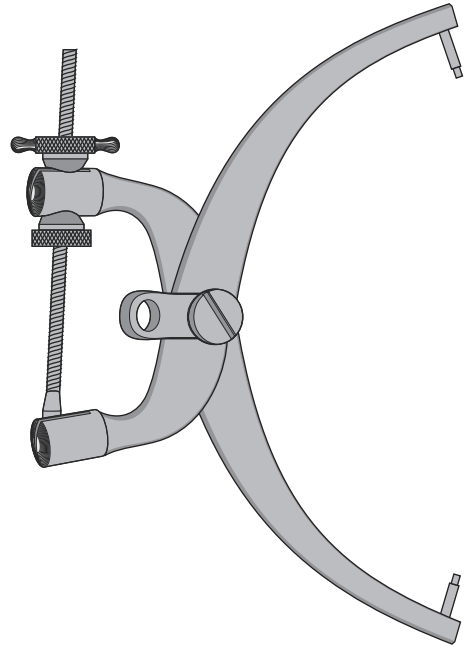

CRUTCHFIELD  
WIS-FF-397



WIS-FF-398

Doppelschlüssel zu FF-398

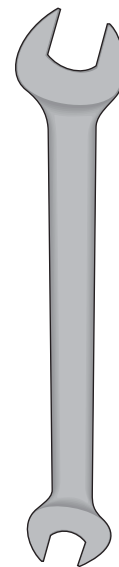

WIS-FF-399

Amputation  
Amputazione

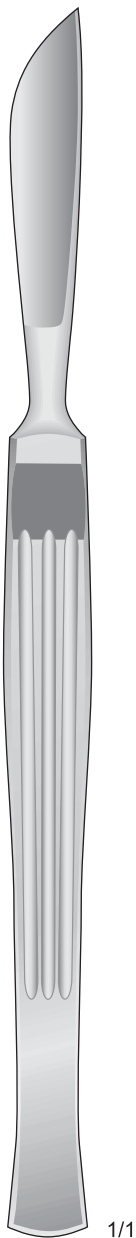

**WIS-NK-31/WIS-NK-57**



**WIS-NK-50**  
150 mm

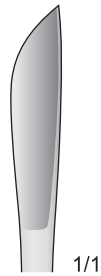

**WIS-NK-51**  
155 mm



**WIS-NK-31**  
158 mm



**WIS-NK-52**  
160 mm



**WIS-NK-53**  
170 mm

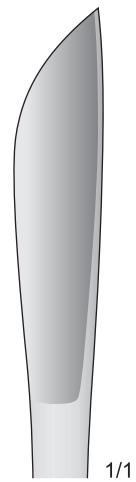

**WIS-NK-35**  
175 mm

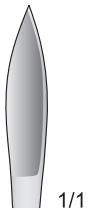

**WIS-NK-54**  
150 mm

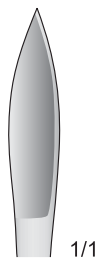

**WIS-NK-55**  
155 mm

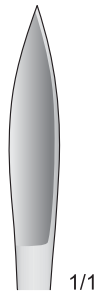

**WIS-NK-33**  
158 mm

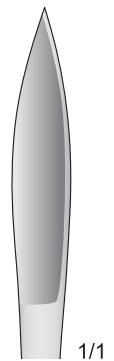

**WIS-NK-56**  
160 mm

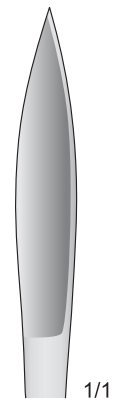

**WIS-NK-57**  
170 mm

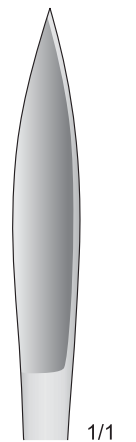

**WIS-NK-37**  
175 mm

mm: Schnittlänge  
Length of blades  
Lunghezza della lama  
Largo de hojas  
Longueur de la lame

Metallheft  
Metal handle  
Manico in metallo  
Mango metálico  
Manche métal

Holzheft  
Wooden handle  
Manico in legno  
Mango de madera  
Manche bois

Metallheft  
Metal handle  
Manico in metallo  
Mango metálico  
Manche métal

Metallheft  
Metal handle  
Manico in metallo  
Mango metálico  
Manche métal

Resektionsmesser  
Resection knives  
Coltello per resezione  
Cuchillos para resección  
Couteaux à résection

Organmesser  
Post mortem knives  
Coltello per autopsia  
Cuchillos para órganos  
Couteaux à autopsie

Organmesser  
Post mortem knives  
Coltello per autopsia  
Cuchillos para órganos  
Couteaux à autopsie

Hirnmesser  
Brain knives  
Coltello per cervello  
Cuchillos para cerebro  
Couteaux à cerveau

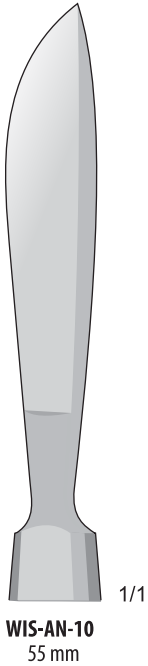

**WIS-AN-10**  
55 mm

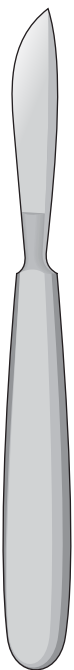

LANGENBECK  
**WIS-AN-10/WIS-AN-11**  
55 mm

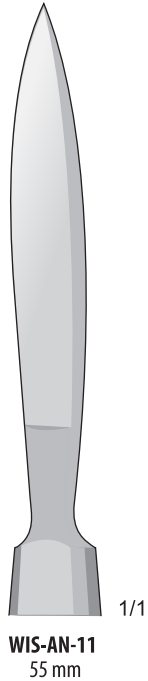

**WIS-AN-11**  
55 mm



**WIS-AN-12**  
110 mm

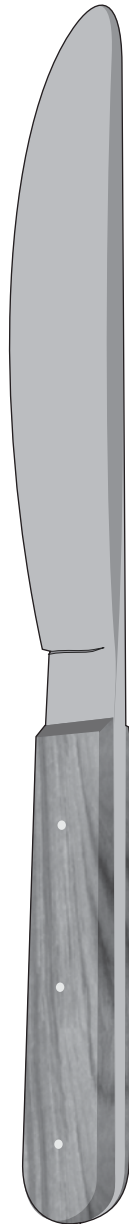

**WIS-AN-13**  
170 mm



**WIS-AN-14**  
195 mm

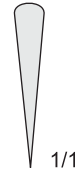

VIRCHOW  
**WIS-AN-15**  
160 mm



VIRCHOW  
**WIS-AN-16**  
200 mm

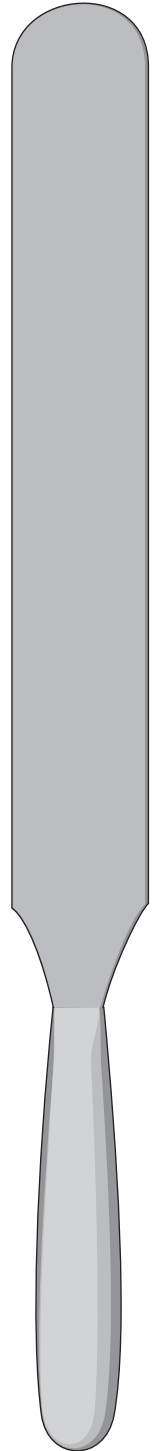

VIRCHOW  
**WIS-AN-17**  
240 mm



Coppia  
(2 pezzi)

1 paar  
1 pair

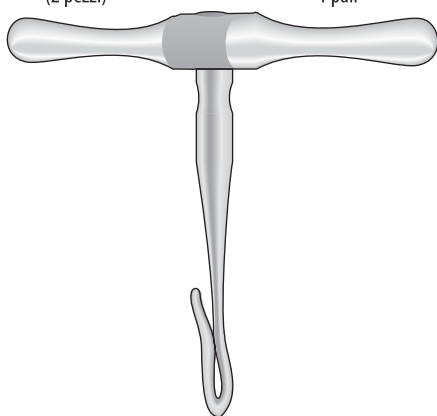

GIGLI  
WIS-FK-11

Rostfrei  
Stainless  
Inox  
Acciaio

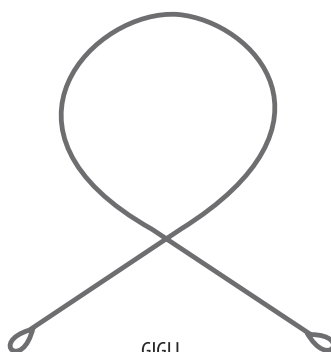

GIGLI  
WIS-FK-13  
300 mm  
WIS-FK-14  
500 mm

**WIS-LS-300**

Komplett mit 3 S?gen  
Complete with 3 saws  
Completa con 3 seghe  
Completo con 3 sierras  
Complet avec 3 scies

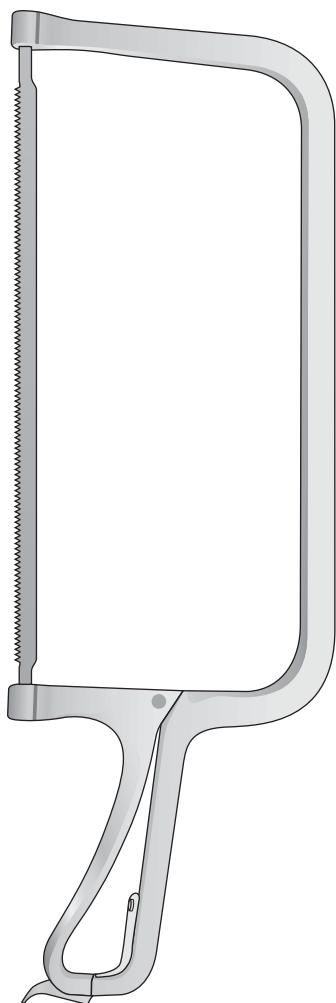

COLLIN  
WIS-LS-300  
390 mm

Fig.1



WIS-LS-301  
280 mm

Fig.2



WIS-LS-302  
280 mm

Fig.3



WIS-LS-303  
280 mm

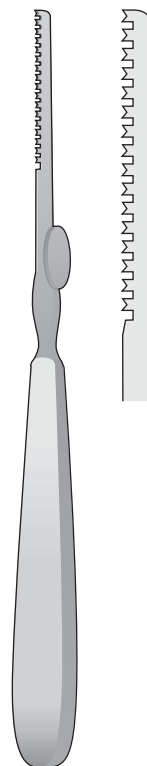

LINDEMANN  
WIS-FK-243  
200 mm



LANGENBECK  
WIS-FK-244  
235 mm

Skalpellsklingen  
und Skalpellgriffe

Scalpel Blades  
and Handles

Lame e manici  
per bisturi

Hojas y mangos  
de bisturí

Lames et manches  
de bistouris



**WIS-LB-361**  
Conf. 10 pz.



**WIS-LB-364**  
Conf. 10 pz.



**WIS-LB-367**  
Conf. 10 pz.



**WIS-LB-362**  
Conf. 10 pz.



**WIS-LB-365**  
Conf. 10 pz.



**WIS-LB-368**  
Conf. 10 pz.



**WIS-LB-363**  
Conf. 1 pz.

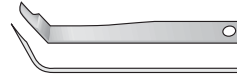

**WIS-LB-366**  
Conf. 1 pz.



**WIS-LB-369**  
Conf. 1 pz.

**WAA** WAAORTHO  
INDUSTRY  
Sialkot Pakistan



**WIS-NK-01**  
100 mm



**WIS-NK-02**  
150 mm



**WIS-BB-46**  
135 mm



**WIS-BB-48** - 155 mm



CASPAR  
**WIS-BB-50**



CASPAR  
**WIS-BB-52**

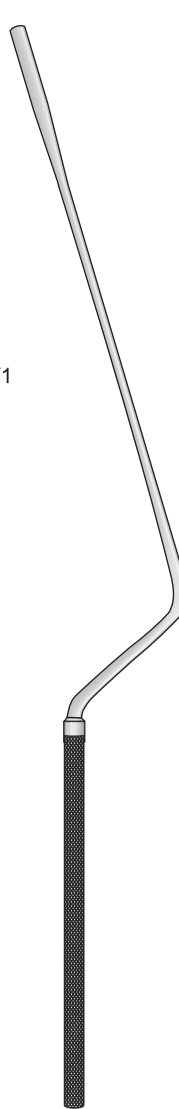

LANDOLT  
**WIS-BB-38**  
250 mm

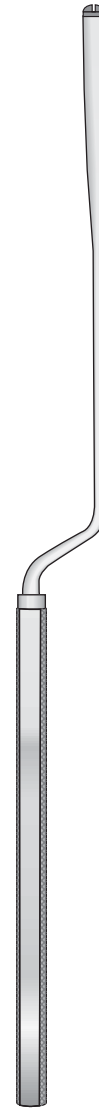

LANDOLT  
**WIS-BB-40**  
210 mm

**Towel Clamps**

Tuchklemmen  
Pince ?xe-compresses  
Pinzas de campo  
Fissateli

**Scissors**

Scheren  
Ciseaux  
Tijeras  
Forbici

**Tissue Forceps**

Chirurgische Pinzetten  
Pinces à tissus  
Pinzas quirúrgicas  
Pinzette chirurgiche

**Needle Holders**

Nadelhalter  
Porte-aiguilles  
Porta-agujas  
Port?aghi

**Hemostatic Forceps**

Arterienklemmen  
Pinces hémostatiques  
Pinzas hemostáticas  
Pinzette emostatiche

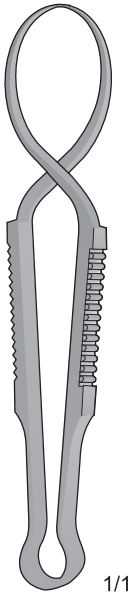

SCHAEDEL  
WIS-BF-38  
85 mm

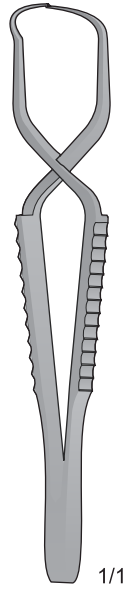

FAURE  
WIS-BF-40  
85 mm

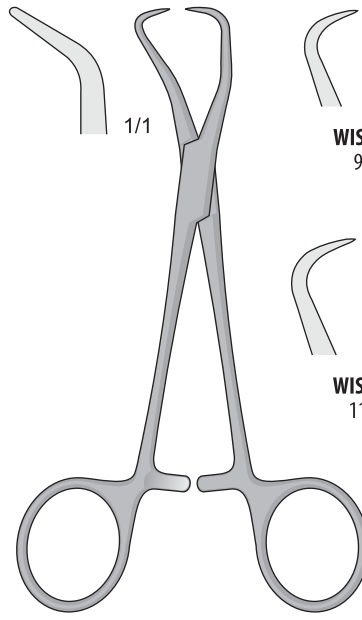

BACKHAUS  
WIS-BF-41/WIS-BF-46

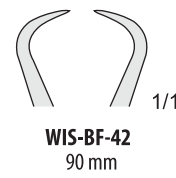

WIS-BF-42  
90 mm

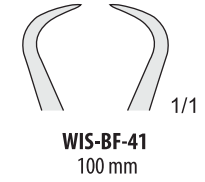

WIS-BF-41  
100 mm

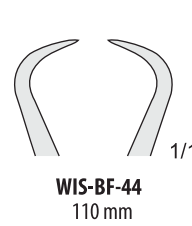

WIS-BF-44  
110 mm

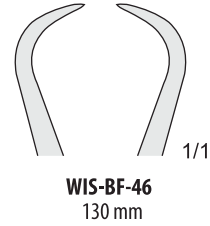

WIS-BF-46  
130 mm

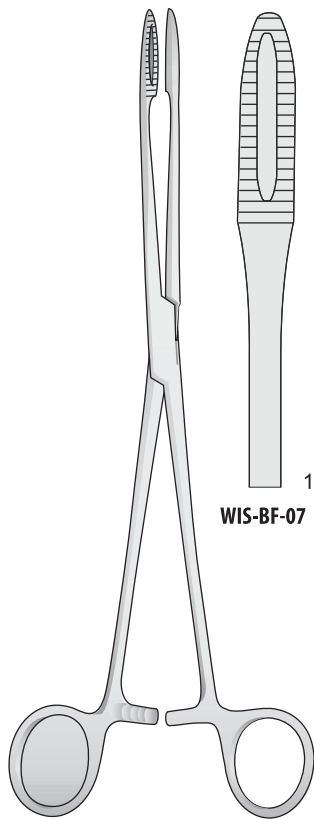

MAIER  
WIS-BF-07/WIS-BF-08  
265 mm

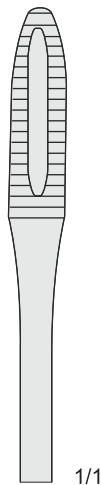

WIS-BF-07

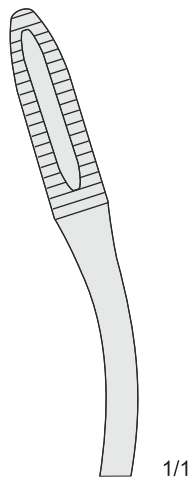

WIS-BF-08

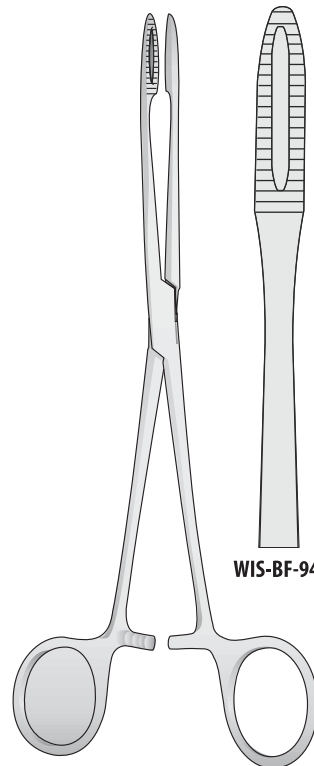

GROSS  
WIS-BF-94/WIS-BF-95  
200 mm

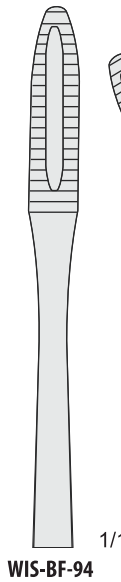

WIS-BF-94

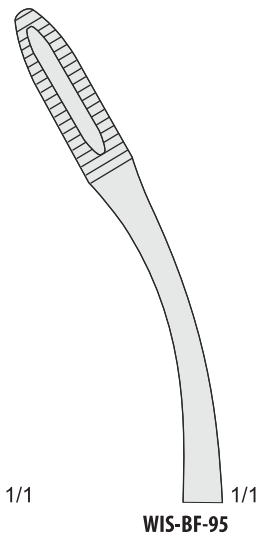

WIS-BF-95





**?Ribbon type?**

Mit gro?en Ringen  
 With large rings  
 Forbici ad anelli grandi  
 Con anillos especialmente grandes  
 avec larges anneaux

Irisscheren - Iris scissors  
 Forbici per iridectomia - Tijeras para iridectomia  
 Ciseaux ? iridectomie

Blepharoplasty  
 Biefaroplastica

Spitz - Sharp  
 Acuta - Aguda  
 Pointu

- Spitz  
 Acuta - Aguda  
 Pointu

Spitz - Sharp  
 Acuta - Aguda  
 Pointu

Stumpf - Blunt  
 Smussa - Romas  
 Mousse

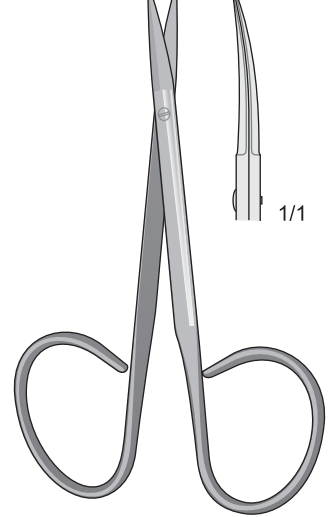
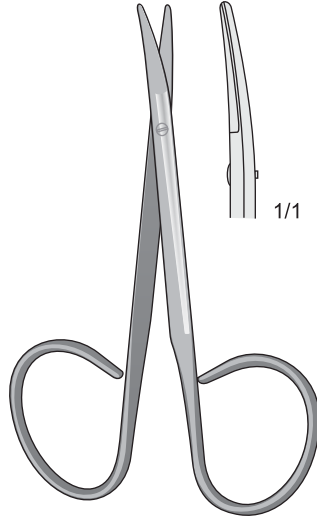
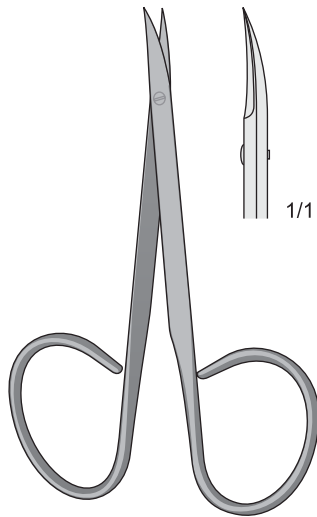
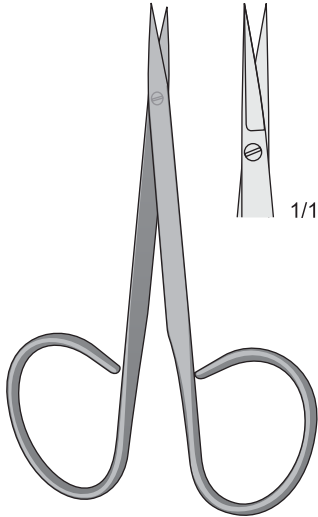

**WIS-FG-200**  
95 mm

**WIS-FG-201**  
95 mm

**WIS-FG-202**  
95 mm

**WIS-FG-203**  
105 mm

Strabismusscheren - Strabismus Scissors  
 Forbici da strabismo - Tijeras para estrabismo  
 Ciseaux ? strabisme

Irisscheren - Iris scissors  
 Forbici per iridectomia - Tijeras para iridectomia  
 Ciseaux ? iridectomie

Stumpf - Blunt  
 Smussa - Romas  
 Mousse

Stumpf - Blunt  
 Smussa - Romas  
 Mousse

Spitz - Sharp  
 Acuta - Aguda  
 Pointu

Spitz - Sharp  
 Acuta - Aguda  
 Pointu

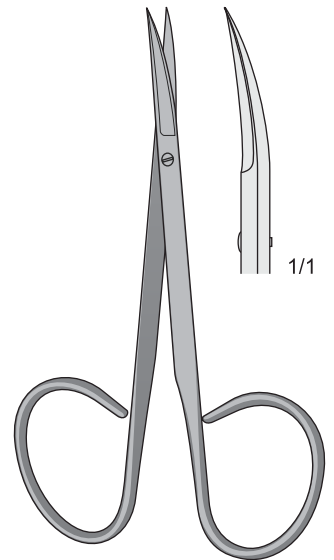
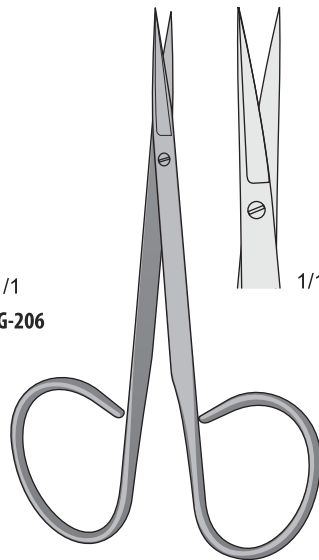
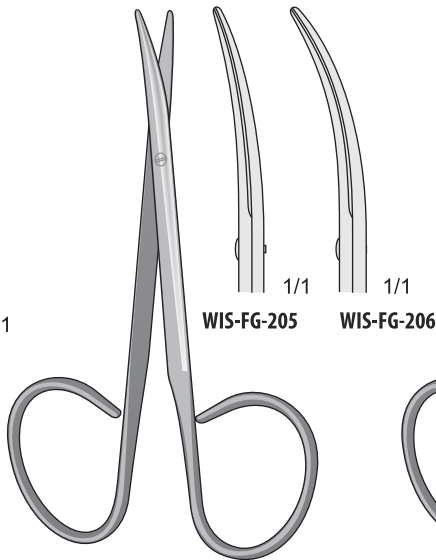
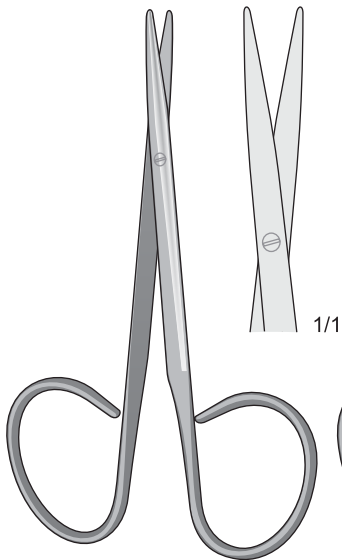

**WIS-FG-204**  
100 mm

**WIS-FG-205/WIS-FG-206**  
100 mm

**WIS-FG-207**  
105 mm

**WIS-FG-208**  
105 mm

**Company: WAA Ortho Industry**

Proprietor :Samina Wasim

Address: Raja Road Bucher Khana 22/325 Sialkot Pakistan

ChambSCCI Registration Number: A-70741

Tel: +92-52-4588427

Cell: +92-3106234115

Whatsaap:+92-3374745643

Emails: [info@waaortho.com](mailto:info@waaortho.com)

[waaortho@gmail.com](mailto:waaortho@gmail.com)

**Web: [waaorthoind.com](https://waaorthoind.com)**